



23 JUNE 2023

EUROPE'S RAIL JOINT UNDERTAKING

Consolidated Annual Activity Report 2022

In accordance with Article 26 of Council Regulation (EU) No 2021/2085 of 19 November 2021 and with Article 23 of the EU-Rail Financial Rules.

The Europe's Rail Joint Undertaking (EU-Rail) became the legal and universal successor of the Shift2Rail Joint Undertaking (S2R JU or S2R). Hence, EU-Rail has succeeded in the management of the S2R JU Research and Innovation Programme.

However, in this report, references may still be made to S2R Programme, S2R Other Members, S2R R&I, S2R Regulation, S2R JU, S2R etc. to identify all the activities and governance inherited by EU-Rail and related to the former S2R JU.



CONTENTS

FACTSHEET	4
FOREWORD	9
INTRODUCTION	10
EXECUTIVE SUMMARY	13
S2R Programme Status	13
EU-Rail Programme Status.....	18
Other activities	21
EU-Rail response to the pandemic and the management of related measures	22
1. IMPLEMENTATION OF THE WORK PROGRAMME 2022-2024.....	23
1.1. Key objectives 2022, associated risks and corrective measures	23
1.2. Research & Innovation activities/achievements: the S2R Programme	29
1.2.1. IP1 Cost-efficient and Reliable Trains, including high-capacity trains and high-speed trains.....	36
1.2.2. IP2 Advanced Traffic Management and Control System	51
1.2.3. IP3 Cost-Efficient and Reliable High-Capacity Infrastructure	68
1.2.4. IP4 IT Solutions for Attractive Railways Services	79
1.2.5. IP5 Technology for Sustainable and Attractive European Rail Freight.....	92
1.2.6. CCA Cross Cutting Activities.....	107
1.2.7. IPx activities - Disruptive Innovation and Exploratory research.....	114
1.3. Research & Innovation activities/achievements: the EU-Rail Programme.....	119
1.3.1. System Pillar	119
1.3.2. Innovation Pillar.....	126
1.4. Calls for proposals, grant information and other funded actions	130
1.4.1. Grants.....	130
1.4.2. Operational tenders and contracts	131
1.5. Evaluation procedures and outcomes	133
1.6. Follow-up activities linked to past calls	136
1.7. Openness, cooperation, synergies and cross-cutting themes and activities.....	142
1.8. Progress against KPIs	144
1.8.1. H2020 KPIs	144
1.8.2. Progress against General HE KPIs.....	145
1.8.3. Progress against HE Common JUs KPIs.....	145
1.8.4. Progress against JU-specific KPIs	145
1.9. Dissemination and information about project results.....	145
2. SUPPORT TO OPERATIONS	147
2.1. Communication activities	147



- 2.2. Legal and financial framework 149
- 2.3. Budgetary and financial management 150
- 2.4. Financial and in-kind contributions from Members other than the Union 155
 - 2.4.1. Europe's Rail in-kind Contributions 155
 - 2.4.2. S2R in-kind Contributions 156
- 2.5. Administrative Procurement and contracts 162
- 2.6. IT and logistics 163
- 2.7. Human Resources 164
 - 2.7.1. HR Management 164
 - 2.7.2. Efficiency gains and synergies 165
- 2.8. Data protection 169
- 3. GOVERNANCE 170
 - 3.1. Major developments 170
 - 3.2. Governing Board 170
 - 3.3. Executive Director 171
 - 3.4. States Representatives Group 171
 - 3.5. Scientific Committee 172
 - 3.6. Deployment Group 173
 - 3.7. System Pillar Steering Group 173
 - 3.8. Innovation Programme's Steering Committees (SteCos) 174
 - 3.9. European Union Agency for Railways (ERA) 174
- 4. FINANCIAL MANAGEMENT AND INTERNAL CONTROL 176
 - 4.1. Effectiveness of controls 176
 - 4.1.1. Legality and regularity of the financial transactions 176
 - 4.1.2. Fraud prevention, detection, and correction 181
 - 4.1.3. Assets and information, reliability of reporting 184
 - 4.2. Efficiency of controls 185
 - 4.3. Economy of controls 185
 - 4.4. Cost-effectiveness of controls 187
 - 4.5. Audit observations and recommendations 188
 - 4.5.1. Internal Audit 188
 - 4.5.2. Audit of the European Court of Auditors 188
 - 4.5.3. Overall Conclusions 190
 - 4.6. Assessment of the effectiveness of internal control systems 190
 - 4.6.1. Continuous monitoring 190
 - 4.6.2. Risk assessment and management 191
 - 4.6.3. Prevention of Conflict of Interest 192

4.7. Conclusion on the assurance	192
4.8. Statement of Assurance.....	193
4.8.1. Assessment of the Consolidated Annual Activity Report by the Governing Board.....	193
4.8.2. Declaration of assurance	194
5. ANNEXES	195
ANNEX A: Organisational structure of EU-Rail	196
ANNEX B: Establishment plan and additional information on HR management	197
ANNEX C: Publications and external events participated to by the joint undertaking in 2022	199
ANNEX D: Patents from projects	225
ANNEX E: Scoreboard of Horizon 2020 (H2020) legacy KPIs	226
TABLE I - Horizon 2020 Key Performance Indicators common to all JUs	226
TABLE II - Indicators for monitoring H2020 Cross-Cutting Issues common to all JTI JUs	232
TABLE III - Key Performance Indicators specific for EU-Rail.....	238
TABLE IV – Initial Estimation – Release 5 - of the Key Performance Indicators of the Shift2Rail Programme	241
ANNEX F: HORIZON EUROPE KPIs	244
Scoreboard of Horizon Europe common Key Impact Pathway Indicators (KIPs)*	244
Horizon Europe Partnership common Indicators	246
Scoreboard of KPIs specific to EU-Rail	251
ANNEX G: IKA REPORT	255
ANNEX H: FINAL ANNUAL ACCOUNTS	257
Balance Sheet.....	257
Statement of financial performance	258
Cash flow statement	259
Statement of changes in net assets.....	260
ANNEX I: MATERIALITY CRITERIA.....	261
ANNEX J: LIST OF ACRONYMS	263
ANNEX K: INFORMATION PERTAINING TO THE FORMER SHIFT2RAIL JOINT UNDERTAKING	267
List of Members of the S2R JU until 29/11/2021	267
Factsheet of the S2R JU as at 29/11/2021	268
ANNEX L: LIST OF FOUNDING MEMBERS OF THE EUROPE'S RAIL JOINT UNDERTAKING	270

FACTSHEET

Name	Europe's Rail Joint Undertaking – as of 30/11/2021 (hereinafter “EU-Rail”)
Objectives¹	<p>EU-Rail is an autonomous body with its own legal personality. It is an institutional European partnership as per Article 187 of the Treaty on the Functioning of the European Union dedicated to managing and coordinating mission-oriented R&I activities for a major transformation in rail systems in Europe.</p> <p>The general objectives of EU-Rail are to:</p> <ul style="list-style-type: none"> (a) contribute towards the achievement of the Single European Railway Area; (b) ensure a fast transition to more attractive, user-friendly, competitive, affordable, easy to maintain, efficient and sustainable European rail system, integrated into the wider mobility system; (c) support the development of a strong and globally competitive European rail industry. <p>The main task of EU-Rail is to deliver a high-capacity integrated European railway network by eliminating barriers to interoperability and providing solutions for full integration, covering traffic management, vehicles, infrastructure and services, aiming to achieve faster uptake and deployment of projects and innovations.</p>
Legal basis	<p>Article 187 of the Treaty on the Functioning of the European Union².</p> <p>The founding legal Act of EU-Rail is the Council Regulation (EU) 2021/20853 of 19 November 2021, which entered into force on 30 November 2021, establishing the Joint Undertakings under Horizon Europe (hereafter the “Single Basic Act” or the “SBA”). By means of SBA, the EU-Rail was established and became the legal and universal successor of the former S2R JU, which it replaced and succeeded as from that date. In addition, in its first meeting, the EU-Rail Governing Board approved the list of decisions adopted by the S2R JU that will continue to apply for EU-Rail in accordance with Article 174(12) of the SBA⁴.</p>
Executive Director (ED)	<p>Mr Carlo M. Borghini, until 28 February 2023⁵.</p> <p>Mr Giorgio Travaini, appointed ED ad interim as from 1 March 2023⁶.</p>
Governing Board of EU-Rail	<p>European Commission (EC) members:</p> <ul style="list-style-type: none"> • Henrik Hololei, DG MOVE until 31 March 2023 <p>EC alternates:</p> <ul style="list-style-type: none"> • DG MOVE Kristian Schmidt • DG RTD Rosalinde Van Der Vlies <p>Industry members:</p> <ul style="list-style-type: none"> • ADIF Luis Fernando López

¹ The key objectives pertaining to the S2R Programme, pursued by the former Shift2Rail Joint Undertaking, and inherited by its successor – EU-Rail, are the following:

- a 50 % reduction of the life-cycle cost of the railway transport system (i.e. costs of building, operating, maintaining and renewing infrastructure and rolling stock),
- a 100 % increase in the capacity of the railway transport system,
- a 50 % increase in the reliability and punctuality of rail services (measured as a 50 % decrease in unreliability and late arrivals).

² [OJ C 202, 7.6.2016, p. 131–131](#)

³ OJ L 427, 30.11.2021

⁴ EU-Rail GB Decision n° 02/2021

⁵ Based on the confirmation of early retirement of Mr Borghini by means of the [EU-Rail GB Decision n° 01/2023](#).

⁶ Based on the [EU-Rail GB Decision n° 02/2023](#).

<ul style="list-style-type: none"> • ALSTOM • ANGELRAIL consortium led by MER MEC • AŽD • CAF • CEIT • ČD • DEUTSCHE BAHN • DLR • eSGR JV • Faiveley Transport • Ferrovie dello Stato Italiane • HITACHI RAIL STS • INDRA-TALGO • Jernbanedirektorate • KNORR-BREMSE • ÖBB • PKP • ProRail-NS Groep • SIEMENS • SNCF • Strukton • THALES • TRAFIKVERKET • Voestalpine Railway Systems 	<p>Nicolas Castres Saint Martin</p> <p>Francesco Inzirillo</p> <p>Vladimir Kampik</p> <p>Jorge De Castro</p> <p>Juan Melendez</p> <p>Tereza Kunertová</p> <p>Ralf Marxen</p> <p>Christian Sattler</p> <p>Noemi Jimenez Redondo</p> <p>Roberto Tione</p> <p>Roberto Tundo</p> <p>Antonella Trombetta</p> <p>Jose Miguel Rubio Sanchez</p> <p>Preben Saethre</p> <p>Hans-Christian Hilse</p> <p>Mark Topal Goekceli</p> <p>Jancewicz Zbigniew</p> <p>Karel van Gils</p> <p>Roland Edel</p> <p>Christophe Cheron</p> <p>Tjark de Vries</p> <p>Alberto Parrondo</p> <p>Bo Olsson</p> <p>Jochen Holzfeind</p>
<p>Industry alternates:</p> <ul style="list-style-type: none"> • ADIF • ALSTOM • ANGELRAIL consortium led by MER MEC • AŽD • CAF • CEIT • ČD • DEUTSCHE BAHN • DLR • eSGR JV • Faiveley Transport • Ferrovie dello Stato Italiane • HITACHI RAIL STS • INDRA-TALGO • Jernbanedirektorate • KNORR-BREMSE • ÖBB • PKP • ProRail-NS Groep • SIEMENS • SNCF 	<p>David-Ibán Villalmanzo Resusta</p> <p>Richard French</p> <p>Vincenzo Scarnera</p> <p>Michal Pavel</p> <p>Imanol Iturrioz Villalba</p> <p>Jaizki Mendizabal</p> <p>Petr Jindra</p> <p>Marek Zajic</p> <p>Hans-Peter Lang</p> <p>Michael Meyer zu Hörste</p> <p>Svenja Hainz</p> <p>David Sanz</p> <p>Jose Solis Hernandez</p> <p>Celestino Martinez</p> <p>Paolo Pagliero</p> <p>Riccardo Santoro</p> <p>Carlo Crovetto</p> <p>Alfredo Gonzalez Moreno</p> <p>Pal Midtlien Danielsen</p> <p>Martin Ertl</p> <p>Bertram Ludwig</p> <p>Fojud Arthur</p> <p>Jeroen Fukken</p> <p>Lars Deiterding</p> <p>Ralf Kaminsky</p> <p>Gilles Quesnel</p>

	<ul style="list-style-type: none"> • Strukton • THALES • TRAFIKVERKET • Voestalpine Railway Systems <p style="text-align: right;">Henk Samson Yves Perreal Christer Lofving Uwe Ossberger</p> <p>Other participants:</p> <ul style="list-style-type: none"> • Giorgio TRAVAINI <p style="text-align: right;">Executive Director ad interim of EU-Rail</p> <p>Observers:</p> <ul style="list-style-type: none"> • Josef Doppelbauer (ERA) • Ana Gigantino (ERA) • Ny Tiana Tournier (ERA) • Roland Moser (ERRAC) • Marta Garcia (ERRAC) • Angela Di Febbraro (SC) • Miroslav Haltuf (SRG)
Other bodies	<p>System Pillar Steering Group Deployment Group States Representatives Group (SRG) Scientific Committee (SC)</p>
Number of staff	28 posts as at year-end 2022 ⁷
Total budget 2022	<p>By means of the GB Decision 08/2021 of 25 November 2021, the S2R Governing Board adopted the initial Annual Work Plan and Budget for 2022 which continued to apply to EU-Rail by means of adoption by the EU-Rail Governing Board of the so-called “omnibus decision”.</p> <p>By the time of such adoption, the budget appropriations included in the Budget 2022 were not foreseen to cover the full financial year 2022, but to ensure the running of the activities till the launch of the new partnership, the Europe's Rail Joint Undertaking, and to ensure the necessary business continuity of the activities.</p> <p>There were three amendments to the initial budget adopted during 2022:</p> <ul style="list-style-type: none"> - <u>Amendment number 1</u>: to ensure that the EU-Rail Programme budget was included for the year 2022 following the official initiation of the new Partnership and with the Work Programme 2022 converted into a multi-annual work programme that included the activities that will be performed in 2022 related to the launch of its new Research and Innovation (R&I) Programme governed by the Horizon Europe rules (in particular two Calls for Proposals) as well as estimated figures for the following years up to 2024. This could be done in accordance with the new legal and financial regulatory options offered with the new SBA adoption. - <u>Amendment number 2</u>: Following the signature in 2022 of a Contribution Agreement between the European Union, represented by the European Commission, and EU-Rail, with the objective to provide a financial contribution to finance the implementation of the action “Pilot project - IRS Smart Cities project: new railway station concept for green and socially inclusive smart cities”, the revenue of EU-Rail 2022 was

⁷ The full staffing as per the JU's Staff Establishment Plan comprises 29 posts. One SNE position was not yet filled as at yearend 2022. In addition, until the new Executive Director is appointed, as of 1 March 2023, the Head of Programme executes the post of the ED ad interim.

	<p>increased by EUR 700.000 in Commitment appropriations and EUR 350.000 in Payment appropriations. In accordance with the SBA Article 10(4), the new revenue in 2022 are corresponding to additional Union funds complementing the contribution allocated to the EU-Rail Programme implementing Horizon Europe. In this respect, and in accordance with SBA Article 10(6), this additional contributions from Union programmes corresponding to additional tasks entrusted to EU-Rail shall not be accounted for in the calculation of the Union maximum financial contribution to the EU-Rail Programme.</p> <p>In addition, the GB agreed to transfer the amount of unused appropriations for the running costs of the JU for the amount of EUR 1,5 million to Title 4 for operational activities. This possibility is established in accordance with SBA Article 28(5) mentioning that any unused part of the contribution for administrative costs may be made available to cover the operational costs of the JU, in particular an additional topic in relation to the European DAC Delivery Programme activities.</p> <ul style="list-style-type: none"> - <u>Amendment number 3</u>: minor adaptations of the budget appropriations per line considering the evolution of budget needs identified for the last quarter 2022, followed by budget transfers of appropriations authorised by the Executive Director in accordance with the JU Financial Rules Article 12.2. <p>As a result, the budget as finally adopted amounted to:</p> <p>Commitment appropriations: EUR 171,4 million</p> <p>Payment appropriations: EUR 180,8 million</p>
<p>Budget implementation</p>	<p>The implementation rate of the operational budget in commitment appropriations was 100% and 79% in payment appropriations (84% in 2021). In 2022, a major portion of payment appropriations was used for the pre-financing of the grants resulting from the first 2022 call for proposal.</p> <p>Commitment appropriations total consumption: EUR 169,5 million – 100% Further breakdown by Titles in EUR and in % of total, excluding unused appropriations:</p> <p>Title 1 – EUR 2,9 million – 100%</p> <p>Title 2 – EUR 2,1 million – 100%</p> <p>Title 3 - 4 – EUR 164,5 million – 100%</p> <p>Payment appropriations total consumption: EUR 139,8 million – 79% Further breakdown by Titles in EUR and in % of total, excluding unused appropriations:</p> <p>Title 1 – EUR 2,7 million – 94%</p> <p>Title 2 – EUR 1,5 million – 84%</p> <p>Title 3 - 4 – EUR 135,6 million – 79%</p> <p>The reported implementation also includes EUR 76.000 relating to the Expert Evaluators which is managed by the REA Services.</p>

	<p>In 2022 with the conclusion of the grant agreements derived from the first call of 2022, the first 6 Flagship Areas and the Transversal Topics have been covered with the award of 6 Flagship Projects.</p> <p>Additionally, in 2022 the JU launched a second call, to cover the Flagship Area 7 on “Innovation on new approaches for guided transport modes” and the “Exploratory Research and other activities”. This latter call is still under is still under grant agreement preparation, as planned, at Q2 of 2023.</p> <p>For the Shift2Rail Programme, the year 2022 mainly entailed ensuring the proper execution of ongoing activities. By the end of 2021, the JU had signed 101 grant agreements in total since its autonomy in 2016. With the Calls 2021 R&I activities up and running, the R&I activities performed in the Programme will reach EUR 800 million (including Lighthouse Projects as part of the S2R initiative), of which EUR 650,7 million performed by the S2R Other Members with a funding made available by the JU up to a maximum of EUR 303,3 million. At the end of 2022, 56 of the 101 S2R projects were closed. Consequently, the S2R Programme is continuing its phasing out, with the objective of closing it by 2024.</p>
Grants/Tenders	<p>The value of 6 signed grants resulting from the first 2022 call⁸ corresponds to EUR 420,6 million of eligible costs, and EUR 583,4 million of total project value, that will be funded by EU-Rail up to EUR 232,5 million.</p> <p>In 2022, contracts/orders (legal commitments) amounting to EUR 14,8 million were signed, of which EUR 12,7 million resulted from operational procurements and EUR 2,1 million from administrative procurements.</p>
Strategic Research & Innovation Agenda	<p>In the context of EU-Rail, as defined in the SBA, the “Strategic Research and Innovation Agenda” (SRIA) represents the document covering the duration of Horizon Europe that identifies the key priorities and the essential technologies and innovations required to achieve the objectives of the JU. In accordance with SBA Article 86(5), the SRIA of EU-Rail is constituted by its Master Plan⁹.</p>
Call implementation	<p>Number of calls launched in 2022: 2 Number of proposals submitted: 23 Number of evaluated proposals: 20 Number of proposals retained for funding: 14</p>
Participation, including SMEs	<p>Total number of beneficiaries in funded projects: 463</p> <ul style="list-style-type: none"> • 24,41% of which are SMEs receiving 13,43% of total EU funding provided by EU-Rail, • 66,52% of which are private for-profit companies receiving 70,73% of total EU funding provided by EU-Rail. • 8,86% of which are non-EU entities receiving 9,07% of total EU funding provided by EU-Rail. <p>44 SME participations were part of the evaluated proposals in the two 2022 calls combined, out of which 20 SME participations were included in the proposals retained for funding.</p>

⁸ The grants resulting from the second 2022 call were awarded in the course of 2023 and the related figures will be presented in the 2023 CAAR.

⁹ https://rail-research.europa.eu/wp-content/uploads/2022/03/EURAIL_Master-Plan.pdf

FOREWORD

2022 was an ambitious and successful year achieving the ramp up phase of the Europe's Rail Joint Undertaking and its Programme which are now fully operational, including Innovation Pillar, System Pillar and, soon, the Deployment Group. At the same time, 2022 was a pivotal year for the innovation programmes of Shift2Rail. All the technical demonstrators have either already demonstrated results of the intense work that has been ongoing since the launch of the programme or are gearing towards final preparation steps for demonstrations to happen in 2023.

The Research and Innovation activities performed under the new EU-Rail integrated Programme are covering innovative solutions' lifecycle, from exploratory research to pre-implementation and deployment, are designed to deliver the transformation of the rail sector needed to answer clients' needs, passengers and supply chain. Not only to contribute addressing the European Green Deal but also the energy crises and new challenges. During 2022 the Founding Members have been working together to operationalize their commitment to the JU submitting major proposals to the Call 2022-1, that following an open, transparent and independent assessment resulted in 6 Flagship Projects covering Phase 1 of the EU-Rail Programme. These projects were operational by the end of 2022. In parallel, the System Pillar was funded following a major call for tender.

2022 was marked also for the consistent implementation of a system approach to rail evolution, driven by the European Commission – DG MOVE policy, where EU-Rail represents the research and innovation arm length and ERA the key system authority for ERTMS and telematics applications. This creates the opportunity for the European rail industry to bring forward its views and ambitions with “one voice” with the expectation for a systemic and coherent approach at institutional level.

Nevertheless, the EU-Rail Programme does not cover all the necessary developments for telecommunications and localization which became, during 2022, matter of increased attention. While with regard to localization, leveraging from the past work in S2R, appropriate work items have been embedded in the setting up of the Flagship Projects, although requiring integration with activities outside the Programme, telecommunications remained a point of attention. While it is clear that the next generation of telecommunications is a key component for the digital rail, the need for resources to deal with it from the R&I point of view as well as the integration within a coherent architecture at European rail system level has only been started.

The launch of the Research and Innovation activities of the EU-Rail integrated Programme, building upon the results and advances of the S2R programmes, shapes the mission-oriented nature of the JU, building on openness and inclusiveness, answering the call of the Member States and Parliament to deliver impact and added value to European citizens. Synergies with other Union – as well as national and regional – programmes and partnerships shall provide opportunities to complement the series of actions expected from the rail sector, including interacting with ERRAC on complementary activities. Stakeholder relations, communication and dissemination of results ensure the visibility and uptake of the progress achieved. Sound financial and risk management and compliance will underpin the implementation of the Programme along its lifecycle.

The cohesion that EU-Rail has created within the European rail industry builds upon a small team of passionate professionals dedicated to deliver this new ambitious integrated Programme.

The Executive Director in charge until 28 February 2023 and the new Executive Director ad interim would like to express all their gratitude to the EU-Rail Founding Members, the S2R Members, the EU-Rail staff, the Member States representatives and the observers for the collaboration and support during 2022 making those significant results possible.

INTRODUCTION

EU-Rail was established by Council Regulation (EU) 2021/2085 of 19 November 2021 establishing the Joint Undertakings under Horizon Europe and repealing Regulations (EC) No 219/2007, (EU) No 557/2014, (EU) No 558/2014, (EU) No 559/2014, (EU) No 560/2014, (EU) No 561/2014 and (EU) No 642/2014 (hereinafter also the “Single Basic Act” or “SBA”), which entered into force on 30 November 2021. In accordance with Article 174(6) of the SBA, EU-Rail is the legal and universal successor in respect of all contracts, including employment contracts and grant agreements, liabilities and acquired property of the Shift2Rail Joint Undertaking which it replaced and succeeded.

EU-Rail is an autonomous body with its own legal personality having its seat located in Brussels, Belgium. It is an institutionalised European partnership as per Article 187 of the Treaty on the Functioning of the European Union dedicated to managing and coordinating mission-oriented Research and Innovation (R&I) activities for a major transformation in rail systems in Europe.

The Vision of EU-Rail is

To deliver, via an integrated system approach, a high capacity, flexible, multi-modal, sustainable and reliable integrated European railway network by eliminating barriers to interoperability and providing solutions for full integration, for European citizens and cargo.

The mission statement of EU-Rail is

“Rail Research and Innovation to make rail the everyday mobility”

In accordance with article 87(1) of the SBA, the members of EU-Rail are the Union, represented by the Commission, and 25 Private Members¹⁰. The Private Members of EU-Rail were selected via an open and transparent process, started with an “invitation to manifest the interest to become Candidate Founding Member of the Transforming Europe’s Rail System European Partnership” on 13 August 2020 and concluded with the listing of 25 entities retained as Founding Members in Annex II of the SBA. The Private Members of EU-Rail signed a Letter of Commitment in accordance with the provisions of the SBA to deliver the contributions established in its Article 89.

The objective of Europe’s Rail Joint Undertaking is to deliver a high-capacity integrated European railway network by eliminating barriers to interoperability and providing solutions for full integration, covering traffic management, vehicles, infrastructure and services, aiming to achieve faster uptake and deployment of projects and innovations. That should exploit the huge potential for digitalisation and automation to reduce rail’s costs, increase its capacity and enhance its flexibility and reliability, and should be based upon a solid reference functional system architecture shared by the sector, in coordination with the European Union Agency for Railways (ERA).

In addition to the General and Specific Objectives common to all JUs established in Title II, Chapter 1 of the SBA, EU-RAIL is also entrusted with the following:

General Objectives

- (d) contribute towards the achievement of the Single European Railway Area;
- (e) ensure a fast transition to more attractive, user-friendly, competitive, affordable, easy to maintain, efficient and sustainable European rail system, integrated into the wider mobility system;
- (f) support the development of a strong and globally competitive European rail industry.

Specific objectives

- (a) facilitate research and innovation activities to deliver an integrated European railway network by design, eliminating barriers to interoperability and providing solutions for full integration, covering traffic management, vehicles, infrastructure also including integration with non-standard national gauges, such as 1520, 1000 or 1668 mm railway, and services, and providing the best answer to the needs of passengers and businesses, accelerating uptake of innovative solutions to support

¹⁰ As per Article 2(5) of the SBA, “Private Member” means any legal entity established under public or private law that is a member of a joint undertaking other than the Union, participating states or international organisations.

- the Single European Railway Area, while increasing capacity and reliability and decreasing costs of railway transport;
- (b) deliver a sustainable and resilient rail system: by developing a zero-emission, silent rail system and climate resilient infrastructure, applying circular economy to the rail sector, piloting the use of innovative processes, technologies, designs and materials in the full life cycle of rail systems and developing other innovative solutions to guided surface transport;
 - (c) develop through its System Pillar a unified operational concept and a functional, safe and secure system architecture, with due consideration of cyber-security aspects, focused on the European railway network to which Directive 2016/797 applies, for integrated European rail traffic management, command, control and signalling systems, including automated train operation which shall ensure that research and innovation is targeted on commonly agreed and shared customer requirements and operational needs, and is open to evolution;
 - (d) facilitate research and innovation activities related to rail freight and intermodal transport services to deliver a competitive green rail freight fully integrated into the logistic value chain, with automation and digitalisation of freight rail at the core;
 - (e) develop demonstration projects in interested member states;
 - (f) contribute to the development of a strong and globally competitive European rail industry;
 - (g) enable, promote and exploit synergies with other Union policies, programmes, initiatives, instruments or funds in order to maximise its impact and added value.

As defined in the SBA, the “Strategic Research and Innovation Agenda” (SRIA) represents the document covering the duration of Horizon Europe that identifies the key priorities and the essential technologies and innovations required to achieve the objectives of the JU. In accordance with SBA Article 86(5), in the case of EU-Rail, its Master Plan shall constitute the SRIA.

The EU-Rail’s Master Plan builds also upon the “Rail Strategic Research and Innovation Agenda”¹¹ of the European Rail Research Advisory Council (ERRAC). ERRAC is a research platform composed of representatives from most of the major European railway research stakeholders: manufacturers, operators, infrastructure managers, the European Commission, EU Member States, academics and users’ groups. Its mission is to deliver a vision of the railway’s future enabled by Research and Innovation activities.

The Master Plan provides guidance for the Europe’s Rail Joint Undertaking’s more specific tasks, namely:

- develop in its System Pillar a system view that reflects the needs of the rail manufacturing industry, the rail operating community, Member States and other rail private and public stakeholders, including bodies representing customers, such as passengers and freight and staff, as well as relevant actors outside the traditional rail sector.

The ‘system view’ shall encompass:

- the development of the operational concept and system architecture, including the definition of the services, functional blocks, and interfaces which form the basis of rail system operations;
- the development of associated specifications including interfaces, functional requirement specifications and system requirement specifications to feed into Technical Specifications for Interoperability (TSI) established pursuant to Directive (EU) 2016/797 or standardisation processes to lead to higher levels of digitalisation and automation;
- ensuring the system is maintained, error-corrected and able to adapt over time and ensure migration considerations from current architectures;
- ensuring that the necessary interfaces with other modes, as well as with metro and trams or light rail systems, are assessed and demonstrated, in particular for freight and passenger flows;

- perform the research and innovation activities necessary to achieve the objectives of EU-Rail, including low TRLs rail-focused research and innovation activities. In that respect, EU-Rail shall:

- define and organise the research, innovation, demonstration, validation and study activities to be carried out under its authority, while avoiding fragmentation of such activities;
- exploit standardisation and modularity opportunities, and facilitate the interfaces with other modes and systems;
- develop demonstration projects;

¹¹ https://rail-research.europa.eu/wp-content/uploads/2020/12/RAIL-Strategic-Research-and-Innovation-Agenda-2020-FINAL_dec2020.pdf

- develop close cooperation and ensure coordination with related European, national and international research and innovation activities in the rail sector and beyond as necessary, in particular under Horizon Europe, thereby enabling the Europe's Rail Joint Undertaking to play a major role in rail-related research and innovation while also benefiting from scientific and technological advances reached in other sectors;
- perform any tasks necessary to achieve the objectives set out in SBA Articles 4 and 85.

- facilitate the market uptake of rail innovation developed in the Europe's Rail Joint Undertaking and to support deployment of the innovative solutions through the establishment of a Deployment group pursuant to Article 22 of the SBA.

Five areas of priority for EU-Rail have been determined in its Master Plan:

- 1) European rail traffic management and supporting rail's key role in a multimodal transport system
- 2) Digital and automated train operations
- 3) Sustainable and digital assets
- 4) Competitive digital green rail freight
- 5) Smart solutions for low density traffic lines (cost-efficient regional lines)

These priorities will be underpinned by a system view to ensure a harmonised approach to the evolution of the Single European Rail Area. They will be complemented by forward-looking activities, tackling disruptive technologies and thinking, through performing exploratory research and other complementary activities.

EXECUTIVE SUMMARY

2022 marked the first year of the new institutionalised European partnership, Europe's Rail Joint Undertaking (or EU-Rail) officially established on 19 November 2021 by Council Regulation (EU) 2021/2085. It is the new institutionalised European partnership on rail research and innovation established under the Horizon Europe programme (2021-2027) and the universal successor of the Shift2Rail Joint Undertaking. At the beginning of 2022, the Governing Board, following the setting up of the JU's bodies, was in the position to formally adopt the Master Plan, the Multi-Annual Work Programme and the first Work Programme 2022 – 2024.

The vision of EU-Rail is to deliver, via an integrated system approach, a high capacity, flexible, multi-modal, sustainable and reliable integrated European railway network by eliminating barriers to interoperability and providing solutions for full integration, for European citizens and cargo.

EU-Rail aims to accelerate research and development in innovative technologies and operational solutions. This will support the fulfilment of European Union policies and objectives relevant for the railway sector and the competitiveness of the rail sector and the European rail supply industry. In this way, EU-Rail will accelerate the penetration of integrated, interoperable and standardised technological innovations necessary to support the Single European Railway Area (SERA).

EU-Rail builds upon the results and activities carried out by its predecessor, the S2R JU, which was established as a public-private partnership under the Horizon 2020 Framework Programme¹² to manage and coordinate mission-oriented Research and Innovation (R&I) activities for a major transformation in rail systems in Europe.

The S2R strategic objectives and targets remain more than valid also within the framework established by the new "Sustainable and Smart Mobility Strategy" adopted by the European Commission on 9 December 2020¹³.

2022 activities were influenced by a new crisis resulting from the illegal aggression of Ukraine by Russia. Although EU-Rail research and innovation has not been directly impacted by the situation, it is not possible to anticipate at this stage the consequences of such dramatic events. At the same time, Covid-19 continued to impact the progress and finalisation of the S2R Programme R&I activities.

Beyond the operational activities, 2022 saw the preparation, design and implementation of Article 13 SBA, where EU-Rail took over the responsibility for the coordination of the Back Office Arrangement (BOA) – Accounting Services. Other three BOAs were established under the leadership of other JUs with EU-Rail taking up an active supporting role in those as well.

In terms of organizational changes, at the meeting of the Governing Board of 30 November 2022, the Executive Director informed the Board of his intention to step down from his position in advance to the end of his second mandate. He notified the Governing Board that his decision would have been formalized in 2023, once the necessary administrative steps would be completed. This was formalized on 9 January 2023, when the ED notified his end of service as from 28 February 2023; on 30 January 2023 the Governing Board appointed Mr Giorgio Travaini, Head of the Programme, as Executive Director ad interim as from 1 March 2023.

S2R Programme Status

2022 was a pivotal year for the innovation programmes of Shift2Rail. All the technical demonstrators have either already demonstrated results of the intense work that has been ongoing since the launch of the Programme or are gearing towards final preparation steps for demonstrations to happen in 2023.

¹² Regulation (EU) No 1291/2013 of the European Parliament and of the Council of 11 December 2013 establishing Horizon 2020 - the Framework Programme for Research and Innovation (2014-2020), OJ L 347, 20.12.2013 and Council Decision (EU) No 2013/743/EU of 3 December 2013 establishing the specific programme implementing Horizon 2020 (2014-2020), OJ L 347, 20.12.2013, p. 965.

¹³ <https://eur-lex.europa.eu/legal-content/EN/TXT/?uri=CELEX%3A52020DC0789>

The operational impact of Covid-19 pandemic, with the 6 months of additional delays reported in 2021, could not be shortened with the year of 2022, therefore the Programme itself is largely continuing with testing activities in 2023, having generated a number of additional extension amendments for those projects that optimistically thought they could catch up in 2022.

As per 2021, in this context, the work of S2R Other Members, other beneficiaries and of the JU staff shall be commended because they have collectively and individually ensured the progress of the research and innovation activities showcased also at the InnoTrans 2022 JU's and companies' stands, where for the first time innovative interoperable European solutions worked in Shift2Rail appeared in future commercial solutions.

By the end of 2022, the S2R Programme reached pivotal milestones in term of Programme implementation:

- all S2R resources are committed for the Programme activities and all planned IPs/CCA related activities are running in granted projects,
- on average, about 89% of the Programme has been realized and 91% in terms of financial Programme execution, in view of reaching the TRL6/7 operational demonstrations planned for conclusion during 2023. In total, it is estimated that the total value of the activities performed in 2022 amounts to EUR 102,4 million, of which EUR 92 million delivered by the Members other than the European Union (hereinafter "S2R Other Members").

During 2022, the JU assessed its R&I activities through a fourth Control Gate exercise¹⁴. This exercise took into account the deliverables and reports submitted in the context of the Annual Review of the active projects coordinated by the S2R Other Members. The JU also ensured through this process that the recommendations made during the previous Control Gate Assessment had been properly applied. The overall result is that the Programme benefited from such feedback, built also upon external expertise.

This Programme assessment allowed the JU to confirm that overall, the progress of the activities has been in line with the expectations. In addition, the system approach activities within IPx allowed providing various elements to speed up the ramp-up of the EU-Rail System Pillar activities.

Only a small number of TDs show delays compared to the initial scheduling, mostly due to issues with availability of resources and external factors. In such cases, the JU has requested the concerned Project Teams to put in place the necessary mitigating measures.

IP1

In 2022, IP1 TDs progressed significantly with a jump from the overall TD completion rate estimated in 2021 to 63%, reaching 83% in 2022. Overall IP1 finalised with submission of deliverables representing 86% of the estimated work planned in 2022. TD1.1 (traction), TD1.8 (HVAC) and TD1.6 (Doors and Access Systems) were the main contributors in 2022 for this progress, catching up the delays they had in 2021. TD1.2 (TCMS) progress is more modest, in particular with regard to the submission of final deliverables, attributable to some delays in the electronics supply chains continuing in 2022. TD1.3 and TD1.4 also suffered similar delays in the submission of finalised deliverables in 2022. On the positive side, different demonstrations showcased at InnoTrans, contributing to the dissemination and exploitation activities, either at the JU stand or at the different members' stands, mostly representing EU-Rail rolling stock sub-systems innovation such as related to carbodies, running gear, accessibility solutions and interiors.

Regarding TD1.1, significant progress has been achieved during 2022. The lab tests performed on a sub-urban SiC based traction system including a new traction motor and final demonstrations carried out on regional trains deserve a special mention in this respect. With reference to TD1.3, all subcomponents were manufactured for the demonstrators using all the moulds and manufacturing engineering that was developed, whereas under TD1.4, a bogie component health monitoring system for the detection of anomalies in running gear components was developed, as well as the work towards optimised materials enabling substantial weigh reductions continued.

¹⁴ In accordance with the procedure set in the S2R Governance and Process handbook, transparently published on the JU's website: https://rail-research.europa.eu/wp-content/uploads/2021/03/S2RJU-Governance-and-Process-Handbook_20200303_v2.0.pdf

As for TD1.5, a concept for electro-mechanical brake has been proved against the operational requirements and adhesion management solutions were also tested in operational conditions. Concerning TD1.6, the prototypes for door leaves were manufactured, the performance tests were finalized, and demos were made in coordination with the work carried out within TD1.7 on train modularity concepts.

The HVAC work within TD1.8 progressed with tests that shown the feasibility to achieve the same thermal comfort using an HVAC unit with natural refrigerants and the reduced consumption of energy with the introduction of heat pumps. Pre-standardisation work related to HVAC classes and interfaces has been also carried out.

IP2

Significant progress has been reported on all TDs. For the whole IP2 a very good 96% completion rate of the work planned for 2022 was reached on average. The work on TD2.5 “train integrity” was finalized at the end of 2022 and laboratory activities with simulators and demonstrators were successfully carried out, including activities for on-board installation and on-field testing. Three demonstrators have been performed for OTI class 1 and train length determination, Class 2 and train length determination as well as for Class 3 and train length determination. A full assessment is foreseen within the last project reporting related to 2022.

Regarding TD2.1 on Adaptable communication, tests have taken place in France and Germany as well as in the United Kingdom to demonstrate the concept for both mainline/highspeed and suburban traffic. For moving block the experts involved in the work have tested two concepts: fixed virtual blocks and full moving block.

As regards TD2.3 it is close to finalisation, with ATO over ETCS Grade of Automation 4, the technical demonstrator has done preparatory work to be able to gear towards testing in 2023. Results will constitute a major basis for further evolution in the future. As for fail safe train positioning (TD2.4), work is advancing on the preparation of tests which will take place in 2023 as well. To note that as per April 2023, the ATO GoA2 specifications developed under S2R have been implemented in the Member States approved set of Technical Specification for Interoperability (TSI 2023 package).

TD2.4 on Safe Train Positioning reported small progress in 2022 and it is a point of the attention for the Programme finalisation in 2023, having reached an estimated TD completion rate of 68%.

Finally, the activities for TD2.9 Traffic Management were almost concluded in 2022, however not all delays of the previous year in deliverables submission could have been addressed in full. Despite that, demonstrations of the different prototypes developed inside the Programme were performed. The demonstrators covered the following areas: Connected Driver Advisory System (C-DAS), Wayside ATO (WATO), general TMS Business Applications such as Dispatching, Conflict Detection & Resolution, Possession Management, presentation of Field Data (Signalling) and Data Integration of different business services e.g. Weather Information and User Interfaces. These demonstrators enabled validation of the integration layer and interoperable data model developed inside the Shift2Rail Programme.

These results represent fundamental elements which will be taken up to higher TRL and integrated in major demonstration activities in the follow-up of the Shift2Rail Programme under Europe's Rail.

IP3

In 2022, this IP continued to progress evenly, with technical progress reported on all TDs, especially in the context of Intelligent Asset Management (IAMS) related TDs, i.e. TD3.6 to 3.8. In average, IP3 has reached an 85% completion rate of the estimated work planned in 2022, with some deliverable submission delays.

In TD3.6-8, Machine Learning models have been tested against “real/live” data to refine the methodologies applied, the algorithms were fine-tuned, and the results were validated based on the feedback coming from the end-users. Multiple anomaly detection and prediction algorithms have been trialled in different scenarios and targeting different assets (e.g. Track Circuits, Switch and Crossing), showing very good results.

Regarding Smart Energy, TD3.10 – Smart Metering – all the Programme activities have been concluded in 2022 with the validation of the tailored-made solutions into three different Uses Cases: it has been

demonstrated that the use of Smart meters supports a better management and utilization of energy such as reduction in energy losses, better distributed power demand, etc. A full assessment is foreseen with the last project reporting of 2022.

For the infrastructure TDs, i.e. from TD3.1 and 3.5, significant progress towards the MAAP objectives has been made in terms of the various sub-system/components developments. Among other, the development and lab testing of an innovative self-sensing cementitious geocomposite, for continuous monitoring and damage identification has been done in TD3.4. In TD3.1, the whole system modelling approach, including hybrid testing approaches with virtual evaluation, have been validated with data from real-world operations from the enhanced S&C Systems.

IP4

Solid progress has been reported on all IP4 TDs, with an average achievement rate close to 100% of the estimated work planned in 2022. The efforts focused on the final release (F-REL) of the Interoperability Framework. The implementation of the F-REL Interoperability Framework (IF) was based on the conclusions of the internal analysis carried out during previous phases, solving identified issues (e.g. related to performance) and responding to new requirements (e.g. Asset Manager and Travel Service Resolver).

Some of the most visible R&I results of 2022 are:

- Several Transport Service Providers (TSPs), from different transport modes, have been integrated to the IF and tested in the pilots (Athens, Helsinki and Brno). The integrated solution included six TSPs that provided Shopping, Booking and Issuing services (e.g. Taxiway, OASA, TMB, AMTU...);
- The travel shopping algorithm was enhanced to also provide itineraries with bike and car;
- Mobility Packages were enabled, as a kind of subscription or travel card that combines several transport products of different modes and operators;
- New validation method is being defined enabling ticket validation without physical interaction with the validation equipment;
- A desktop application dedicated for TSPs to manage real time travellers' supervision and Pol management allowing the display of travellers and network status, with direct messaging to travellers, management of Pol;
- Several demonstrations were performed at InnoTrans 2022, among which the updated Travel Companion app with additional information such as delays, overcrowding, security constraints, quality of service, but also the Business Analytics with new visualisations and new use cases together with an enhanced interoperability framework.

IP5

In 2022, the TDs reached an average implementation rate of 91%, progressing significantly since last year reporting, in particular thanks to the TD5.1 making progress in CBM and the conclusion of the initial R&I work on Digital Automatic Coupling. Also the progress made by TD5.3 converged on the expected wagon demonstrators that were successfully showcased at InnoTrans 2022. Similarly, in TD5.4 technical progress was achieved in development of the last mile battery, traction batteries and auxiliary converters. Works on intelligent video gate, improved timetable planning and real-time yard management in TD5.2 is reported to be on track. TD5.5 on Business analytics and implementation strategies which was concluded last year already, was positively assessed and presented to the ED-SIPB.

Some of the most visible R&I results of 2022 are:

- Two successful test trains were performed for the digital automatic coupler head selection (in Sweden and Germany);
- the Core Market Wagon underwent laboratory tests and was operated on real tracks, with its brake redesigned and tested with positive results. The Extended Market Wagon was showcased in InnoTrans, coupled with telematic solution prototypes on both wagons enabling future freight train digital operations;
- The last mile battery was developed and integrated into a container for testing with real use cases.

CCA

The Cross Cutting Activities reached a 91% level of implementation of activities planned for 2022. During the year, most of the Work Areas have finalised their R&I activities, the only remaining Work Area is the one related to Noise and Vibration; a full assessment of the closed Work Areas is foreseen with the last projects reporting of 2022. In general, most of the WAs have progressed according to schedule. The testing activities which have been heavily impacted by the Covid-19 pandemic were successfully carried out in 2022 and the noise and vibration WA is recuperating from this delay.

Some of the most visible R&I results of 2022 are:

- The final release, Release 5 of the KPI model has been completed which shows that the innovations of the Programme can potentially reach the punctuality and capacity for certain service types for life cycle cost reduction - 16 to 41% can be assumed;
- Last version of the Standardisation Rolling Development Plan was finalised, this will be provided as basis of the EU-Rail Standardisation and TSI Input Plan (for the System Pillar); Detailed standardisation roadmaps on specific topics such as TCMS, DAC, noise, etc. has been developed;
- In the Integrated Mobility Management Work Area, built on achieved results specifying and developing complementary business functions for rail freight operation, interfaces for the integrated communication infrastructure both for Freight and Passenger Transportation has been developed reaching TRL 3-5.

The energy work area defined the energy baseline and calculated the energy saving potential of the Programme, as an outcome of the research done within the S2R Programme, it can be said that, overall at system level, an energy saving of around 9 – 19% can be reached depending on the different service types with the application of the S2R solutions (high speed, regional, urban and freight).

IPX

The System Architecture activities within the IPX continued to support the ramp-up activities and setup of the System Pillar. Resulting from the regular exchanges in the form of workshops and webinars throughout the year 2022, the projects delivered the prefiguring elements for the System Pillar:

- Two consecutive releases of the System Functional Architecture;
- The specification and the set-up of the formal definition of the Conceptual Data Model;
- The demonstration of the applicability of the CDM to concrete railway scenarios through 4 relevant use cases;
- Keeping up to date the ontology dictionary OntoRail by regularly uploading the newest versions of the source models.

The low TRL and PhDs research involving Artificial Intelligence (AI) adoption of AI in rail, the work focused on developing methodological and experimental proofs-of-concept, developing Benchmarks, Models and Simulations. Proof-of-concepts were developed to support the definition of roadmaps, covering the following topics:

- Railway Obstacle Detection and Collision Avoidance;
- Cooperative Driving for Virtual Coupling of Autonomous Trains;
- Predictive Maintenance for Rolling Stock;
- Smart Maintenance at Level Crossings;
- Graph Embedding for Primary Delay Prediction;
- Big Data on Incident Attribution Analysis.

In 2022, a prototype of a cloud-based rail common database for perception scenarios was also produced. This allows to label, analyse and process data and simplify training and testing of AI models, aiming to eventually automatize the whole AI development pipeline.

Exploratory activities on enhancing the train positioning systems through additional perception sensors started in 2022, bringing the possibility of using SLAM – Simultaneous Location and Mapping - in railways. For that purpose, an urban rail vehicle (tram) was modified by fitting radars, lidars and cameras, and tests

began in Summer in the Spanish city of Zaragoza under commercial service. First results are promising, and the experiments will continue in 2023.

PhDs results have also been achieved on the use of Blockchain in rail. A demonstrator was developed, which implements the necessary business flows to traceably exchange blocks of data between industry stakeholders in an ad-hoc context, using condition monitoring data from a third-rail monitoring platform mounted on an in-service passenger vehicle to an infrastructure manager in raw and processed forms.

Also with the support of a PhD, flexible medium voltage DC electric railway systems (MVDC) traction power supply based on controlled bidirectional converters was investigated to improve the connectivity of the railway to the grid and to integrate renewable power sources to the railway electrification system. The developments in 2022 resulted in a lab demonstrator of a modular multilevel converter, developed and used to test a small-scale medium voltage DC traction substation in various load conditions.

In 2022 the activities of the initial research on Hyperloop concluded by delivering the Observatory, the Technical definitions, and the Transferability and roadmap for future research.

S2R Programme Management

In terms of Programme Management, 2022 was the third year during which reviews of Lump Sum projects took place. Experience confirms so far that from an operational perspective the use of Lump Sum for members' projects does not only result in an administrative simplification, but also effectively bundles efforts in the project review to focus on the achievements of results. The fact that the proof of concluded work packages (hence related focus on deliverables and milestone approval) provides the basis for the reimbursement of costs has allowed the JU and consortia to focus their efforts in an effective way in order to ensure the delivery of the projects.

2022 Programme Management continued to be influenced by the pandemic-related consequences of previous (or in some case still actual in part of 2022) restrictions. Delays already occurred in 2021 could not be fully recovered by the concerned projects in 2022, consequently, some of the running activities were reported to continue until the end of 2023, however, still well within the S2R Programme schedule ending in 2024.

With a holistic approach, the role of the JU is also to ensure that interactions between the various IPs are adequately considered and managed, as technological developments in one part of the system could lead to changes in performance, or even create barriers, in other parts. In addition, cross cutting activities include research on long-term economic and societal trends such as customer needs and human capital and skills, which must be taken into account by the different IPs.

EU-Rail Programme Status

The EU-Rail Programme kickstarted in 2022 with an anticipated ramp-up phase of the System Pillar, while the Innovation Pillar marked the assessment of the first 6 Flagship Projects that started their R&I activities in December 2022, with the notable exception of FP5 which already started in July 2022 with a fixed early start date (before the signature of the Grant) to ensure the swift ramp-up of DAC prototypes in view of the 2025-6 demonstration activities.

A framework for continuous exchanges between the System Pillar and Innovation Pillar activities, as part of the Integrated R&I Programme, has been setup in 2022, allowing for a bi-directional flow: both pillars should provide input and output to each other against a clearly defined series of priorities and objectives to be achieved. The Deployment Group, the third pillar of the integrated Programme, is expected to be operationalised in 2023.

In general, the objectives of the integrated Programme include the following:

- contribute towards the achievement of the Single European Railway Area;
- ensure a fast transition to more attractive, user-friendly, competitive, affordable, easy to maintain, efficient and sustainable European rail system, integrated into the wider mobility system;
- support the development of a strong and globally competitive European rail industry.

The System Pillar

The System Pillar is the “generic system integrator” for EU-Rail, and the architect of the future EU’s railway system. It is established under the Single Basic Act as a fundamental activity of EU-Rail, alongside the Innovation Pillar and Deployment Group.

The System Pillar will provide governance, resource, and outputs to support a coherent and coordinated approach to the evolution of the rail system and the development of the system view, based on a formal functional system architecture approach to speed innovation and deployment. The System Pillar brings rail sector representatives under a single coordination body.

To achieve this, the System Pillar will deliver a unified operational concept and a functional, safe and secure system architecture, with due consideration of cyber-security aspects, focused on the European railway network to which Directive 2016/797 applies (i.e. the heavy rail network), for integrated European rail traffic management, command, control and signalling systems, including automated train operation which shall ensure that research and innovation is targeted on commonly agreed and shared customer requirements and operational needs, and is open to evolution.

During 2022 the ramp-up activities of the System Pillar were concluded, and the System Pillar governance and resource were put in place.

System Pillar Ramp-Up activities

In order to prepare for the launch of the System Pillar activities, preparatory activities were funded. These activities successfully delivered:

- The finalised Common Business Objectives;
- The operational vision for CCS, TMS and CMS;
- The governance and working arrangements for the System Pillar.

All of these documents have been approved at the System Pillar Steering Group.

In addition, there was significant work carried out to consolidate architectural inputs from over 500 source documents to facilitate the beginning of the work of the System Pillar itself.

System Pillar start up

A framework contract with value up to EUR 45 million was successfully awarded in July 2022 to the System Pillar consortium. This contract included 3 lots:

- System Pillar Core Group
- System Pillar Tasks and Domains
- CCS TSI Maintenance Activities

The System Pillar Core Group was formally in place in September, and the Tasks and Domains part was set up in October 2022.

All of the activities for the System Pillar start were on time and in line with the planning agreed with the sector.

The Innovation Pillar

The Innovation Pillar is set up to deliver user-focused research, innovation and large-scale demonstrations. It is tasked to deliver the operational and technological solutions which provide the necessary capabilities to transform the European rail system. Its activities are organised in seven Flagship Areas and the Transversal Topic.

In 2022, with the conclusion of the grant agreements derived from the first call, the first 6 Flagship Areas and the Transversal Topics have been covered with the award of 6 Flagship Projects.

Focus was brought on ensuring the links between the different Flagship projects, most notably when exchanges are expected at the level of requirements but also ensuring proper relationships for the demonstration activities which are expected, in most cases, to take place in 2025-6. The JU also ensured that the relationships between the FPs and the System Pillar were rightly set-up considering the input which the System Pillar will provide on the architecture, but also at a latest stage for migration, standardisation and regulatory aspects.



Additionally, in 2022, the JU launched a second call to cover the Flagship Area 7 on “Innovation on new approaches for guided transport modes” and the “Exploratory Research and other activities”. This latter call was still under evaluation, as planned, at the beginning of 2023.

The European DAC Delivery Programme under the leadership of EU-Rail

In July 2020, the Governing Board of the JU endorsed the creation of the European DAC (Digital Automatic Coupler) Delivery Programme (EDDP) proposed by the Executive Director, voicing the request of the railway sector. Building upon the outcomes achieved in S2R's freight related R&I activities (Innovation Programme 5), this Programme brings together the rail sector beyond the Membership to bridge the research work with innovation, including migration planning, towards the deployment of a European DAC solution, built on open and transparent standard specifications. This activity constitutes a major step ahead of the digital rail freight, enabling new operations and services that will contribute meeting the expectations of the Sustainable and Smart Mobility Strategy of the European Commission.

The EDDP integrates, with an independently managed delivery programme (with Mr Mark Topal, CTO of OEBB, appointed as the European DAC Delivery Programme Manager supported by the Co-Manager Jens Engelmann, owner of Railiable), projects like DAC4EU, funded by the German Federal Ministry of Transport and Digital Infrastructure, as well as relevant results from S2R projects under its Innovation Programme 5 on European rail freight.

In 2022 the following was achieved:

- The EDDP participation continuously increased, counting on more than 300 experts and more than 80 companies and organisations involved across Europe and beyond;
- For the first time in Europe work has been achieved with the DAC target operational procedures for the first DAC use cases;
- EU-Rail Flagship Project 5 (FP5-TRANS4M-R, 2022-2026) was awarded and started its activities with 27 beneficiaries and 71 partners in order to achieve:

- The DAC specification for “mechanical/pneumatical”, “energy” and “communication”;
- The Demonstration of Digital Freight Trains in 2025 with DAC Type 4 & 5 incl. Energy and Data Supply, Hybrid Coupler and automated brake test (at TRL 8);
- Preparing further development of Full Digital Freight Train for future demos.
- Operational DAC tests took/are taking place in European countries;
- The development of possible solid and feasible migration scenarios, for the first time in Europe, which will be further worked on by the partners.
- The first iteration of the Cost-Benefit Analysis was performed under the leadership of the European Commission, supported by the previous LCC analysis commissioned by EU-Rail;
- The first European Investment Plan was contracted by EU-Rail and finalised in early 2023¹⁵ by the company EY, setting the basis for further steps for the DAC implementation and deployment strategy.

In 2022 several meetings took place with the ERA DAC Topical Working Group with the aim to agree on a DAC spec that could be adopted in future TSI, supporting the harmonization all across EU rail network. In parallel the S2R project DACcelerate has supported additional CEN CENELEC meetings to standardize DAC specification.

Other activities

The current EU-Rail Staff Establishment Plan was adopted by the Governing Board on 1 March 2022. It introduced new Temporary Agent positions in relation to the new role of the JU in the System Pillar and to further strengthen the support to policy activities with its integrated R&I Programme. According to the Staff Establishment Plan, EU-Rail shall be staffed with 29 staff members including 2 Seconded National Experts. In 2022, most of the vacant posts were being progressively filled, while having no staff members leaving, the JU still experienced some temporary leaves. To fill temporary gaps or long-term absences, the JU also made use of external competencies and expertise to achieve its operational activities, as well as of temporary outsourcing of some administrative tasks.

With regard to communication and dissemination activities, the JU focussed primarily on the supporting activities to the establishment of the newly launched Europe's Rail Joint Undertaking, with a particular focus on the promotion of the new Programme and its objectives and mission, the introduction of the role of the new System Pillar, while also enhancing Europe's Rail focus on demonstration activities and dissemination of relevant results for market uptake, for the ongoing Shift2Rail projects. A dedicated launch ceremony for EU-Rail was organised during the informal Railway Ministerial meeting held in the context of the French Presidency of the Council (Paris, 21st February 2022).

Furthermore, project results were disseminated at various events with Europe's Rail participation, including at the World Congress on Railway Research, Connecting Europe Days, InnoTrans, TRA, Rail Live and during the Europe's Rail Innovation Days (online).

During 2022, the JU also continued its efforts to increase cooperation with Member States, notably through the Portuguese Presidency with the JU's participation to TRA, as well as with international parties. An MoU was signed during the Connecting Europe Days event with CER, UNIFE, and ALL Rail on the launch of a study on the costs and benefits of High-Speed Rail in Europe.

In addition to the efforts on stakeholder involvement, the JU further continued improving its internal organisation as to provide continuous support to its Members and beneficiaries. Attention was paid to the continuous implementing of the internal control framework and to the assessment and management of risks. The JU cooperated with different stakeholders engaged in audit activities, such as the European Court of Auditors, the Internal Audit Service of the Commission, the Common Audit Service exercised by DG RTD or the external auditors auditing the Annual Accounts of the JU. All of these activities have contributed to the continuous assurance regarding the sound financial management of EU funds managed by the Joint Undertaking.

¹⁵ <https://rail-research.europa.eu/publications/european-dac-investment-plan/>

In 2022, the JU submitted to the European Parliament a follow-up report on Parliament's observations provided in its Resolution related to the decision on discharge in respect of the implementation of the JU's budget for the financial year 2020. In this follow-up report, the JU explained its way in which it addressed these observations or intends to address them in the upcoming period. More specifically, it was elaborated on how EU-Rail contributes to developing, integrating, demonstrating, and validating innovative technologies and solutions in order to remove the remaining technical obstacles holding the rail sector back in terms of interoperability. Furthermore, the JU confirmed in the report that the issue with publishing of the CVs as well as of annual declarations of interests of the EU-Rail Governing Board members had been addressed. Explanation was also provided of how the JU addressed the deficiencies identified by the Court of Auditors with regard to the particular sampled operational payments, as well as how EU-Rail in general undertakes to tackle the systemic errors in grants, most importantly by applying simplified cost options, in particular, by means of the lump sum form of funding.

It can be concluded that thanks to the commitment of both the JU Members and the Programme Office, 2022 has seen the JU further continuing its important progress towards delivering the Shift2Rail Programme, and, in parallel, towards making live its new Programme, such as by launching two calls for proposals or by carrying out tasks related to the System Pillar.

EU-Rail response to the pandemic and the management of related measures

In the beginning of 2022, the JU continued in implementing measures designed to protect the staff with regard to the Covid-19 pandemic in alignment with the EC approach. In particular, this was ensured by applying teleworking arrangements, and, when working onsite, by decreasing physical contacts between colleagues and by providing the staff with surgical masks and hydro-alcoholic gel. In parallel, it was ensured, also by deployment of appropriate ICT architecture and concepts, that application of the anti-pandemic measures have no impact on proper functioning of the JU and on carrying out its day-to-day tasks, including those requiring interactions with external parties.

These measures were subject to regular reviews by a dedicated JU working group composed of four staff members which was established already in 2020. This working group has been mandated to monitor the situation and provide to staff information published by different entities (EC, Belgian National Authorities etc.), as well as clarifying mitigation measures during weekly staff meetings or via the dedicated mailbox enabling staff to address the working group with specific questions or concerns.

As of mid-March 2022, the pandemic situation has started becoming more stabilized which enabled progressive easing of the measures and restrictions applied at the JU, in line with the general rules of the host country/municipality and with the approach applied at the Commission.

Not only to promote the way back to normal in terms of increasing physical presence at the office, but also to establish in broader terms the standardized rules regardless of how the pandemic might evolve in the future, the Commission endorsed in March the new Decision on working time and hybrid working (C(2022) 1788 final). EU-Rail, by means of its GB Decision 8/2022, decided to apply this Commission Decision by analogy. Furthermore, to provide additional guidance to their staff, EU-Rail adopted the respective ED Decision to precise how certain provisions regarding hybrid working arrangements will be applied at the JU, such as those regarding additional IT tools to be made available for the staff.

The next sections of this 2022 CAAR present in detail the achievements, risks and opportunities, and the developments pertaining to the JU during the past year.

1. IMPLEMENTATION OF THE WORK PROGRAMME 2022-2024

1.1. Key objectives 2022, associated risks and corrective measures

European Green Deal, the United Nations Sustainable Development Goals, the Sustainable and Smart Mobility Strategy and the Digital Decade

The European Green Deal was presented in December 2019, setting out a clear vision of how to achieve climate neutrality in Europe by 2050¹⁶. Transport accounts for a quarter of the EU's greenhouse gas emissions, and still growing. To achieve climate neutrality, a 90% reduction in transport emissions is needed by 2050. As a matter of priority, a substantial part of the 75% of inland freight carried today by road should shift onto rail and inland waterways.

"To transform the EU into a fair and prosperous society, with a modern, resource-efficient and competitive economy where there are no net emissions of greenhouse gases in 2050 and where economic growth is decoupled from resource use." (European Green Deal, p. 2).

Priority areas include accelerating the shift to sustainable and smart mobility: "Automated and connected multimodal mobility will play an increasing role, together with smart traffic management systems enabled by digitalisation. The EU transport system and infrastructure will be made fit to support new sustainable mobility services that can reduce congestion and pollution, especially in urban areas" (European Green Deal, p. 10).

In July 2021, the so-called "Fit for 55"¹⁷ package was introduced by the Commission – a package consisting of a set of inter-connected proposals making the existing legislation more ambitious, where possible, and even putting on the table new proposals, where needed. The main ambition of the EU under this package is cutting emissions by at least 55% by 2030 by also supporting a faster roll-out, relative to prior objectives, of sustainable transport solutions such as rail. Overall, the package strengthens eight existing pieces of legislation and presents five new initiatives, across a range of policy areas and economic sectors: climate, energy and fuels, transport, buildings, land use and forestry.

The European Green Deal is also an integral part of the Commission's strategy to implement the United Nation's 2030 Agenda and the 17 Sustainable Development Goals (SDGs).¹⁸ The JU has been reporting in its Consolidated Annual Activity Reports already under the S2R Programme on its contribution to the SDGs since 2018. The Joint Undertaking, under its current Programme, will continue in this endeavour, more specifically with regard to these SDGs¹⁹:



SDG 9: Building resilient infrastructure, promote inclusive and sustainable industrialization and foster innovation



SDG 12: Ensure sustainable consumption and production patterns

¹⁶ [European Commission \(2019\). The European Green Deal. COM\(2019\) 640 final, Brussels](#)

¹⁷ <https://eur-lex.europa.eu/legal-content/EN/TXT/?uri=CELEX%3A52021DC0550> and <https://www.consilium.europa.eu/en/policies/green-deal/fit-for-55-the-eu-plan-for-a-green-transition/>

¹⁸ [United Nations General Assembly \(2015\). Transforming Our World: The 2030 Agenda for Sustainable Development. Draft resolution referred to the United Nations summit for the adoption of the post-2015 development agenda by the General Assembly at its sixty-ninth session. UN Doc. A/70/L.1. New York](#)

¹⁹ As also indicated in the Biennial Monitoring Report 2022 on Partnerships in Horizon Europe, page 295: <https://op.europa.eu/en/publication-detail/-/publication/a6cbe152-d19e-11ec-a95f-01aa75ed71a1/language-en/format-PDF/source-search>



SDG 13: Take urgent action to compact climate change and its impacts



SDG 8: Promote sustained, inclusive and sustainable economic growth, full and productive employment and decent work for all



SDG 5: Achieving gender equality and empower all women and girls

More specific insights into how EU-Rail aims at contributing to the broader objectives represented by the SDGs can be obtained from Annex E and Annex F providing information on the Key Performance Indicators/Key Impact Pathway Indicators. However, it should be noted that the precising of indicators for following-up on the EU-Rail Programme under Horizon Europe was not yet finalised in 2022, and this process will still continue in 2023.

Further to the above, the Sustainable and Smart Mobility Strategy of the Commission, launched in December 2020²⁰, includes more concrete milestones for the railway sector to enhance a smart and sustainable future. Its underlying Action Plan of 82 initiatives lays the foundation for how the EU transport system can achieve its green and digital transformation and become more resilient to future crises. In particular, it provides the visionary ambitions that the next rail R&I Programme will have to contribute to insofar as possible and notably:

- By 2030 the high-speed rail traffic will increase by 50%; the scheduled collective travel of under 500 km should be carbon neutral within the EU and automated mobility will be deployed at large scale.
- By 2050 rail freight traffic will double; high-speed rail traffic will triple and the multimodal Trans-European Transport Network (TEN-T) equipped for sustainable and smart transport with high-speed connectivity will be operational for the comprehensive network.

Additionally, rail transport will also need to be further electrified; wherever this is not viable, the use of hydrogen should be increased. And the roll out of the European Rail Traffic Management System (ERTMS) will be pursued including further efforts to develop train automation, for instance through joint undertakings.

Further to the topic of “Digital Decade”, the Commission indicated in its Communication of March 2021²¹ how digital transformation can improve the ecosystems related to mobility and transport. Digitalisation can improve environmental and cost performance and simultaneously increase safety levels contributing to a higher quality of life. It will be achieved through more advanced levels of automation, faster and more reliable connectivity, and IT enabled profound transformation of the management of mobility services. The public could also benefit from fast internet connectivity for passengers on most stations and lines, user-oriented telematics and facilitated multi-modality.

In this context, EU-Rail and its Programme strived for speeding up the development and deployment of innovative technologies in railway transport in order to contribute to achievement of the above-mentioned milestones. This will require a significant transformation of the railway sector, addressing long overdue changes in legacy operational processes, systems and governance models, as well as integrating with other transport and mobility solutions for passenger services and cargo logistics.

²⁰ [European Commission \(2020\). Sustainable and Smart Mobility Strategy – putting European transport on track for the future. COM\(2020\) 789 final, Brussels](#)

²¹ [European Commission \(2021\). 2030 Digital Compass: the European way for the Digital Decade. COM\(2021\) 118 final, Brussels](#)

Besides the efforts made via its R&I Programme, the JU itself and its staff, to the extent corresponding to the size of the organisation, also strived to contribute to the fight against climate change when conducting the day-to-day business. Those “little things” that the JU applies to be as green as possible include:

- Separating waste in the JU's premises,
- Suppression of single-use items,
- Reducing paper consumption by applying paperless workflows to the extent possible,
- Encouraging staff not to commute to work by car by providing a scheme for reimbursement of public transport cost and arrangements supporting commuting by bike.
- Increased usage of online/hybrid meetings and events to reduce the carbon footprint related to travelling.

While the option of moving office in 2022 or early 2023 was eventually not realized, any future decision-making of EU-Rail in this respect will include due considerations regarding the energy-efficiency parameters of the respective premises.

Key objectives 2022

In 2022, the EU-Rail strived within its Programme for speeding up the development and deployment of innovative technologies in railway transport, thereby contributing to the achievement of the EU policy goals. This will require a significant transformation of the railway sector, addressing long overdue changes in legacy operational processes, systems and governance models, as well as integrating with other transport and mobility solutions for passenger services and cargo logistics.

The strategic framework for EU-Rail's endeavours is provided in its Master Plan identifying the ambitions and the objectives of this new partnership and defining a systemic, long-term and result-oriented delivery strategy for research & innovation in the railway sector.

It is under this framework that EU-Rail worked to achieve its objectives of 2022, which were met also with the full commitment of the budget appropriations related to the Horizon Europe funded EU-Rail Programme for the operational activities for the year 2021 (considering the SBA was adopted by the end of November 2021) and 2022. This demonstrates that the JU was able to engage the railway sector to an effective resource commitment to progress in delivering the railway system transformation, through an increasingly integrated Programme.

The Work Programme (WP) and budget 2022-2024 were amended on three occasions mainly to address the start of the EU-Rail Programme new activities and need to support key priorities:

- (1) the adoption of the full EU-Rail Programme budget 2022-2024 on 1 March, replacing the initial light version of December 2021, including the decision on launching the first 2022 Call for proposal,
- (2) the WP amendment introducing the topic description of the second 2022 Call for proposal, and
- (3) the WP amendment by which the IKAA plans of the EU-Rail private Founding Members were adopted in accordance with the SBA requirements.

In 2022, the EU-Rail priorities included:

1. Launching the research and innovation activities identified in the MAWP in the horizon up to 2026, considering the resources available and implementing the multi-annuality by instalment, with the publication, evaluation, award and grant preparation of two calls, one in Q1 and the other in Q3 2022 → Achieved, as further reported in the Executive Summary and Sections 1.3, 1.4 and 1.5;
2. Launching and ramping up of the System Pillar activities, heading towards the first element of the concept of operations and system architecture, that is to set the basis for the future work of the System Pillar → Achieved, as further reported in the Executive Summary and Sections 1.3 and 1.4;
3. Setting up and activating the new governance structure of the JU, in particular with the System Pillar Steering Group and Deployment Group → System Pillar Steering Group set-up and activated, Deployment Group to start in 2023, pending first results from the System Pillar and Innovation Pillar programme works;
4. Reviewing and defining the new structure, processes and procedures to ensure sound management of the EU-Rail activities, with particular regard to the interaction of the two Pillars to maintain the nature of

one integrated R&I Programme → Achieved, as further reported in the Executive Summary and in Section 1.3;

5. Exploring new areas of R&I that could contribute to fostering the system transformation of railway and non-traditional and emerging technologies for land guided systems → Achieved, as further reported in the Executive Summary and in Section 1.3.

In addition, the projects of the S2R Programme entered in their final phase, focusing on:

6. Delivering the R&I for the ERTMS game changers (telecoms, localization, moving blocks, automation), also in view of their integration in the TSI 2022(3) package, with the objective to ensure the evolution of the system towards Baseline 3 and its market uptake → Achieved, as further reported in the Executive Summary and in Section 1.2;
7. Implementing and obtaining final results on the technologies demonstrated through R&I in relevant environment or even system prototypes demonstration in operational environment. In this respect, possible integration of TDs will also be fostered in the different IPs, with a view of showing them at InnoTrans 2022 → Achieved via successful presentation at InnoTrans 2022 and final results delivered in 2023 as per the plan.

In addition, the year 2022 saw the continuation of the close collaboration established between EU-Rail and:

- the European Railway Research Advisory Council (ERRAC),
- the European Union Agency for Railways (ERA),
- other programmes and partnerships, such as the FCH JU, SESAR 3 JU, CLEAN SKY 2 JU, etc. with the objective to establish synergies that will result in coordinated and consistent activities, up to joint projects,
- different associations representing the key stakeholders of the rail sector and beyond,
- third countries programmes, in line with the policy priorities of the Commission and considering the key objective of the competitiveness of the European rail industry.

Finally, in 2022, EU-Rail built on the visibility gained during the European Year of Rail in 2021 and continued conveying the message to European citizens that rail can be the answer to their concerns about other mobility options being unsustainable and unreliable. The JU's key messages and events continued to reinforce the objectives of the European Green Deal and the Sustainable and Smart Mobility Strategy, by disseminating R&I results and showing the future evolution of rail in terms of services for passengers and freight clients.

The following sections of this CAAR describe how the JU's objectives have been pursued, the activities performed on the way towards achieving its goals, and the resources used. In Annexes E and F, the JU's performance is measured against the set of agreed KPIs.

More details related to call for tenders, procurements and contracts concluded and/or launched in 2022 are presented in Sections 1.4 and 2.5.

Delivery of S2R Programme R&I activities

During 2022, through the operational activities, the Programme Office continued the supervision of the implementation of the 105 Projects and operational contracts of the S2R Programme²², awarded and signed since 2016, for an estimated R&I total value of EUR 805,1 million. Additional details are provided in Section 1.6.

The Programme supervision and monitoring was implemented through 44 specific Control Gates (21 project reviews of CFM projects, 23 project reviews of OC projects) and 144 specific issue reviews (79 specific issue reviews of 21 CFM projects, 65 issue reviews of 23 OC projects) in order to continuously assess the submitted technical deliverables with the support of external experts (in the specific field of the deliverables), when needed. The continuous assessment of deliverables has allowed the JU to be efficient in providing timely feedback to the projects for an effective implementation of recommendations and/or requests for changes.

²² 4 Light house projects (2015) not included.

The process of continuous assessment of deliverables consists in the engagement for each output of the project in a swift review, which may need the support of external technical expertise, and in that case, the JU triggers a specific issue review. This process allows EU-Rail to provide in-depth technical feedback to the project not linked only to the reporting period review (the control gates), but throughout the lifetime of the action, allowing a better fine-tuning of the activities in relation to the objectives.

Risks

In Q4 2021, the JU performed a risk assessment exercise with the aim of updating the elements related to risks and opportunities already included in its risk register, as well as identifying potential new ones. The corresponding risks relevant for 2022 associated with the Programme activities and the financial administration of the JU, requiring continuous ED attention (and when relevant, the attention of GB), as well as the corresponding risk mitigating actions have been communicated via the EU-Rail Work Programme 2022-2024. They are summarised in the table below together with an update on follow-up and mitigation actions performed in 2022.

As for the average JU's risk profile pertaining to 2022, as followed from the annual risk assessment performed, and also from the continuous monitoring of risks and opportunities during the year, this was determined by having moderate to high net criticality of the most relevant risks identified.

Risk identified for 2022 in the Work Programme	Action plan	Follow-up on action plan for 2022
<p>Intrinsic to the JU Staff establishment plan, efficiency of operations is impacted by extensive workload, high staff turnover, together with difficulties for the JU to attract new people which may result in positions being filled in with delays, shortage of resources especially (during peak moments), and as a consequence, leading to difficulties in getting the work done and achieving the JU's objectives (continuity); this may include a negative impact on employees' motivation.</p>	<ul style="list-style-type: none"> - Subject to approval of the EU-Rail Staff establishment plan, 6 additional staff members should be introduced, with envisaged positive effects on workload allocation and back-ups in the following period. - A career plan for staff has been prepared. - Enhancing the planning of activities will allow for better personnel risk management. Recruitment of short-term resources (interim or trainees) has been extended. - It is planned to introduce a new multi-annual learning and development policy. - The JU will build on the results of the projects started in 2021 which covered topics such as strategic support, workload, cultural aspects, and coaching. The objective is to address internal issues of work allocation, satisfaction at work, cultural affiliation, wellness, and wellbeing. 	<p>Actions have been implemented:</p> <p>Vacant posts as per the new Staff Establishment Plan have been gradually filled.</p> <p>Internal planning and organisation were refined. Bluebook Trainees were deployed in accordance with the SLA signed with DG EAC, as needed.</p> <p>Activities aimed at enhancing team spirit and work-life balance have been carried out.</p>
<p>The European Commission's Accounting Officer has notified the JU of the intention to terminate the role of Accounting Officer of the JU, except for the treasury function. This was linked to the provisions of the establishment of the Back Office Arrangements (BOA) between the JUs in accordance with the SBA. There is a risk that the qualitative work performed by the Commission Accounting Officer will not be so easily replaced by the BOA, as it</p>	<ul style="list-style-type: none"> - Set up with the other JUs without delay the new Accounting Officer function within the BOA. - Outsource the accounting activities, for example, to private companies which can also sign off the accounts, while keeping in house the Accounting Officer. 	<p>Actions have been implemented:</p> <p>The BOA for accounting have been established among the JUs.</p> <p>Accounting Officer covering BOA, including the accounting services for EU-Rail, was appointed (GB Decision N°12/2022).</p>

Risk identified for 2022 in the Work Programme	Action plan	Follow-up on action plan for 2022
requires skill and competence that are scarce and limited within the EU-Rail as well as overall in all JUs. There is a risk that the transition process and ramp-up phase of the new function would jeopardise the reporting cycle and legal obligations of the JU.		
Inadequate timing of the new legislative framework for EU-Rail becoming effective could lead to having more than one year without calls for proposals for the new Programme under Horizon Europe.	<ul style="list-style-type: none"> - Preparation of the new template documents related to the running of the programme under Horizon Europe. - Keeping all staff informed on the current developments and re-prioritising of tasks and activities, if needed, in order to successfully execute the transition. - Ramp up the programme with the objective to ensure effective implementation of R&I Projects and System Pillar Tasks during Q4 2022 	<p>The SBA entered into force on 30 November 2021 after which activities were carried out related to the launch of EU-Rail and its new Programme.</p> <p>Two calls for proposals were launched by EU-Rail in 2022.</p> <p>Activities related to the System Pillar were carried out.</p>
Absence of proposals of EU-Rail's members and/or other beneficiaries in the first call, or their failure to submit proposals in time or in adequate quality, due to process changes under the new Programme, potentially resulting in the need to re-launch calls and having the research and innovation activities started with delay.	<ul style="list-style-type: none"> - Regular circulation of information regarding the procedures of the new Programme and the Horizon Europe rules. - Intended advanced publishing of the 2022 Annual Work Plan (in draft version) in order to allow everyone to get familiar as soon as possible with the potential topics of the first call. 	<p>Actions have been implemented.</p> <p>Two calls for proposals were launched by EU-Rail in 2022, proposals in adequate number and quality were submitted.</p>
Being a new element under the new Programme, and, given the related possible cautious approach of the industry sector, the System Pillar might have a slower start with regard to the adoption of a system architecture and reflection on European-based operational concepts. This might result in the misalignment between the Innovation Pillar (R&I activities) and the system integration approach.	<ul style="list-style-type: none"> - Timely launch of the ramp-up phase for the System Pillar. - Timely involvement of sector associations. - Assurance of continuity provided through the Steering Process of the Commission. 	<p>Actions have been implemented on an ongoing basis.</p> <p>Meetings of the System Pillar Steering Group were held.</p> <p>A procurement for the award of contract for services related to the System Pillar was carried out.</p>
Impediments emerging during the project lifetime (e.g. changes in regulation, non-achievement of harmonised requirements, unforeseen planning difficulties in resource planning etc.) might lead to the project not being executed in a timely and/or adequate manner preventing the JU's solutions from reaching the market.	<ul style="list-style-type: none"> - Ensure appropriate implementation/exploitation plans in GA and at TD/IP level, as well as via national migration strategies. - Investigate possible instruments to support deployment at EU-level and implement JU strategy/support. - Regular follow up of JU's standardisation roadmaps. - Coordination with RASCOP, and also directly with ERA. <p>CEN/CENELEC/ETSI + regular follow</p>	<p>Adequate monitoring and follow-up on the projects was ensured, also by means of the ED-SIPB meetings.</p> <p>Actions have been implemented on an ongoing basis, as needed.</p>

Risk identified for 2022 in the Work Programme	Action plan	Follow-up on action plan for 2022
This may in particular include force-majeure events (e.g. COVID-19) of longer duration which may lead to difficulties in obtaining the necessary authorisation(s) to organise project demonstrations, resulting in non-completion of such activity in the project concerned.	up at IP SteCo/SIWG + regular updated with EURID WG. - Follow-up on regulatory framework developments. - Change management approach (EDPB). - Continuous risk management and risk response (e.g. regular Covid risk assessment at project level). - Revisions of WP/MAWP/MP.	

In the months of October and November 2022, the JU performed a new risk assessment exercise with the aim of updating the elements related to risks considered relevant for 2023. Within this exercise, due account was taken of topical internal and external factors and developments having influence on JU's business. Attention was given also to the fraud risks, where a separate dedicated risk assessment was carried out in connection with the adoption of the JU's new Anti-Fraud Strategy. The updated EU-Rail risk register was consulted with its parent Commission service – DG MOVE, and the JU also actively participated within the respective cluster of JUs and Agencies in the peer review steered by the EUAN Performance Development Network.

The risks identified in the above-mentioned risk assessment activities which require, due to their criticality, continuous attention and treatment of the Executive Director and, where relevant, of the Governing Board, are presented in the JU Work Programme 2023-2024 and the follow-up outcomes on these risks will be presented in the 2023 CAAR.

In March 2023, IAS confirmed to EU-Rail that their engagement planned to be carried out in the JU in 2023 will take form of a new in-depth risk assessment. EU-Rail will grant to IAS full cooperation in exercising this assessment and will take advantage of its results so that duplication of efforts with similar internal JU activities are avoided.

1.2. Research & Innovation activities/achievements: the S2R Programme

The S2R MAAP translated the S2R Master Plan into detailed, result-oriented R&I activities to be performed with the objective of delivering the S2R vision as from 2016 onwards.

Addressing through R&I the challenges as they were detailed in the MAAP Executive View opened three opportunities for the railway:

- To become the backbone of current and future mobility concepts (e.g. mobility as a service-MaaS) and on-demand future logistics, through integrations with other modes in view of reaching a climate neutral European economy by 2050;
- To identify and establish new market segments for exploitation;
- To enhance the overall competitiveness of the industry, both in Europe and globally.

This is what the S2R Regulation tasked the JU to do when requesting it to manage all rail-focused research and innovation actions co-funded by the Union. Developing the Innovation Capabilities required a coordinated effort among different rail and non-rail stakeholders to drive innovation at all levels in Europe. The S2R Programme was designed to make a decisive contribution to delivering the essential knowledge and innovation that will provide the building blocks to develop the Innovation Capabilities.

The work conducted within the S2R Programme was structured around five asset-specific Innovation Programmes (IPs), covering the different structural (technical) and functional (process) sub-systems of the rail system. These five IPs are supported by work in five cross-cutting areas (CCA) covering themes that are of relevance to each of the projects and which address the interactions between the IPs and the different subsystems:

- IP1: Cost-efficient and Reliable Trains, including high-capacity trains and high-speed trains
- IP2: Advanced Traffic Management & Control Systems
- IP3: Cost-efficient, Sustainable and Reliable High-Capacity Infrastructure
- IP4: IT Solutions for Attractive Railway Services
- IP5: Technologies for Sustainable & Attractive European Freight.



S2R introduced additional IPx activities, R&I designed to look beyond currently planned technology applications (of the Technology Demonstrators) and how to integrate the S2R TDs with new operational concepts. IPx activities help to realise the global optimal approach for this System of Systems which is railway mobility, by starting to build a railway Functional System Architecture and a Conceptual Data Model (CDM).

In addition, in 2020, the JU set up the European DAC Delivery Programme, to bridge the gap towards future industrialization and deployment of a European DAC solution, building upon the work delivered in IP5 on DAC (see the following sections).

With a holistic approach, the S2R Programme ensured that interactions between the various IPs were adequately considered and managed, as technological developments in one part of the system could lead to changes in performance, or even create barriers, in other parts. In addition, cross cutting activities included research on long-term economic and societal trends such as customer needs and human capital and skills, which must be taken into account by the different IPs.

Different types of activities contribute to the Programme development, including:

- studies, fundamental and “blue-sky” research (TRL 0 – 2),
- scientific/applied research and laboratory demonstrations (TRL 3 – 6)
- operational demonstrations and innovation activities (TRL 6-7)
- other supporting activities.

In addition to these activities that were co-funded by the JU and conducted within the scope of the S2R Programme, the former S2R Other Members were required to conduct Additional Activities with a view to

leveraging the effect of the overall R&I. These Additional Activities were not eligible for financial support from the JU but had to contribute directly to the broader objectives set out in the S2R Master Plan.

Since 2020, the management of the Programme benefited also from the regular activities of the ED Programme Board. The ED Programme Board was established as a formal advisory support to the ED and has the role of:

- monitoring the progress of the Programme,
- identifying risks and opportunities and related mitigating actions,
- providing strategic guidance and making recommendations with regard to the management Programme,
- advising the Executive Director in solving issues escalated to his attention in accordance with the S2R Regulation on Programme implementation and propose a way forward,
- advising the Executive Director on the need to complement the Programme with specific expertise to be contracted,
- assisting and advising the Executive Director in any other matter of relevance.

Through its monthly advisory meetings with the Executive Director, the Programme Board has actively supported reflections on and integration of new concepts, ideas, solutions that impacted the Programme. Several change requests have been processes, ensuring among other sectorial coherence of initiatives, notably with the integration of relevant concepts from OCORA or RCA into the S2R R&I activities (projects) that will deliver concrete demonstrations.

The ED Programme Board proved to provide clear benefits to the overall Programme management, anticipating risks and opportunities, ensure higher integration and synergies, addressing issues to avoid negative impact on the expected deliverables.

The progress of the Programme was shared with a wide range of stakeholders during the S2R Innovation Days in December 2022²³.

The practical demonstration of S2R R&I activities is carried out using a combination of single technology demonstrators (TDs), integrated technology demonstrators (ITDs and resulting into the Innovation Capabilities) and theoretical system platform demonstrators (SPDs).

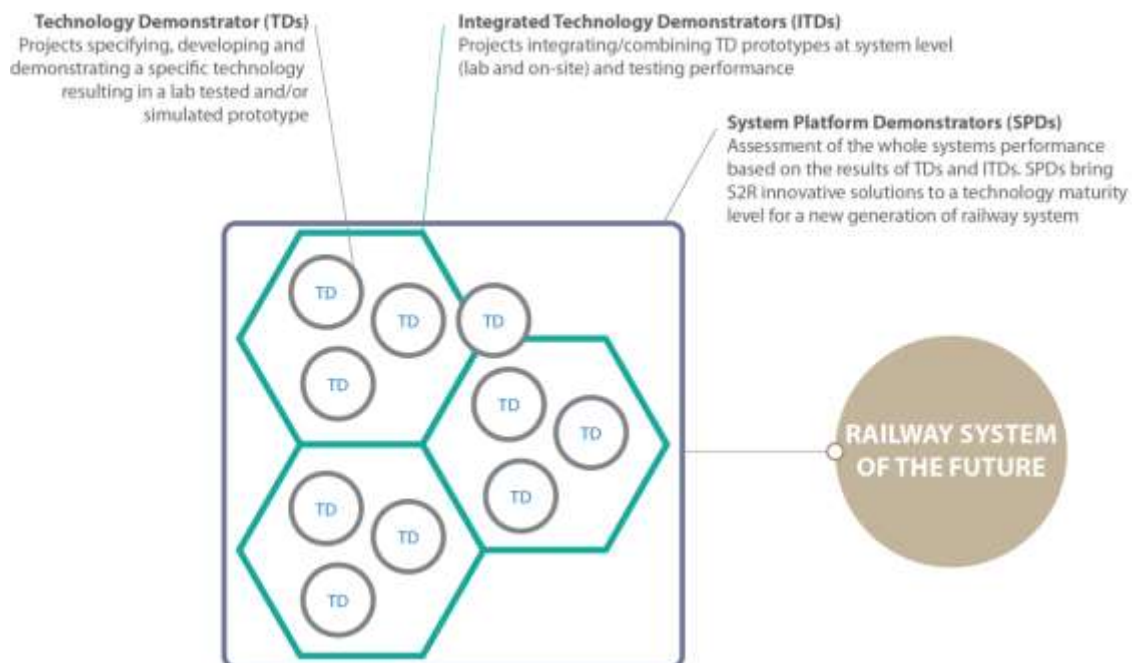

²³ <https://rail-research.europa.eu/calendar/europes-rail-2022-innovation-days/>

The following sections illustrate the progress achieved in the Technology Demonstrators at the end of 2022. The contributions from the TDs to the delivery of the innovation capabilities, as mentioned in the S2R MAAP (Part A), were elaborated in the S2R MAAP (Part B), adopted by the GB in November 2019.

Towards delivering the S2R Programme

An overview of demonstrators with a Technology Readiness Level reaching at least 6 (technology demonstrated in relevant environment), and of which activities have been performed in 2022, is displayed below, together with the provisional planning for test end.

IP	Research Area	Specific Technological demonstration of	characteristics					Overall high level focus/objective
			Market	Testing time - YEAR start	Testing time - YEAR end	Country	TRL	
IP1	TD1.1 Traction	New Technology Traction Systems	Metro	2021	2022	ES	6/7	New generation traction converter based on advanced semiconductor technologies : Reduction in weight and size and increase in energy efficiency
			Regional	2021	2022	FR	6/7	SiC based powertrain demo on a Regional Train
		New Traction Architectures	High Speed	2022	2023	ES	6/7	Traction motor and traction drive architecture
	TD1.2 Train Control & Monit. System (TCMS)	Wireless TCMS	Metro	2023	2023	ES	6/7	Incorporate wireless technologies to the train communication network solutions (i.e. train backbone, consist network and train to ground communication).
			Regional	2023	2023	DE	6	
		Drive-by-data	Metro	2023	2023	ES	6/7	Provide a train-wide communication network for full TCMS support including the replacement of train lines, connecting safety functions up to SIL4 (incl. signalling).
			Regional	2023	2023	DE	6	
		Functional distribution architecture	Metro	2023	2023	ES	6/7	New architectural concept based on standard framework & application profiles, distributed computing to allow execution of compliant functions on end devices distributed meeting different safety & integrity requirements (* TRL of the Regional demonstrator for FDF may be updated.
			Virtual Certification	Generic	2022	2023	ES	
		Generic	2022	2023	DE	5/6	Standardised simulation framework in which all subsystems of the train will be simulated, allowing remote and distributed testing including hardware in-the-loop through heterogeneous communication networks.	
	TD1.3 Carbody Shell	New materials in train carbody structures	High Speed	2022	2023	ES	6	Full high speed intermediate coach interfacing with the adjacent coaches and the running gear, together with the internal interfaces of the main representative equipment of the train (HVAC, etc.) and integrated in a high speed train
	TD1.4 Running Gear	Sensing functionality	Generic	2022	2023	ES, UK, AT/DE	6/7	New health monitoring systems that allows a condition based maintenance of the track with Novel sensor system (hardware), Wireless communication of some sensor, Innovative algorithms
			Regional	2022	2023	HU	6/7	Hardware architecture that allows to combine sensor signals for different monitoring and supervision purposes in an efficient and modular way
		Optimised Materials	Regional	2022	2023	FR	6/7	Composite Antenna Beam: Design of an Antenna Beam out of composite material to reduce weight
		Optimised Materials	High Speed	2020	2022	ES	6	Composite running gear from for independently rotating wheels
		Bogie Control	Generic	2022	2022	AT/DE	6/7	Active wheelset guidance system for reduction of wheelwear and therefore maintenance cost
	TD1.5 Brakes	SIL 3/4 electronic solutions for Brake Control	Urban/Regional	2021	2022	ES	7	Train braking system, based on new architectural HSIL concept, including the replacement of conventional train lines(tbc) and connecting braking safety functions up to SIL4.
		Innovative Friction Pair Solutions		2021	2022	ES	7	High power and eco-friendly friction pairing solution to be tested in a relevant environment
Adhesion Management		2021		2022	ES	7	Function of a new adhesion management concept/ function within an relevant environment on a test train (operational mode)	
Adhesion Management		Generic	2022	2022	DE	6	Function of a new adhesion management concept/ function within an relevant environment on at test train	
TD1.6 Door and Intelligent Access system	PRM access and communicating door	Regional	2021	2023	FR, ES	6/7	New door functionalities like platform detection, passenger detection, passenger protection during boarding aid deployment and retract...: - tests of laser-based solution in operation - data collect on a train in operation with the proposed camera - with the recordings, tests of the algorithms based on IA and/or image treatment	
	Light and high comfort door	Regional	2021	2023	FR	6	Opening and closing mechanism and the leaves new innovative design: - one door will be based on metallic solutions - another door will be based on composite solutions	
TD1.7 Interiors	New Passengers Interiors	Regional	2022	2023	FR, ES	6	New users experiences on board thanks to modular interiors. Physical mock-up and virtual mock-up	
TD1.8 HVAC	HVAC-Technology with natural gases	Regional	2020	2022	DE	7	HVAC Laboratory test and field test in real operation, Reduction of climatic impact, Reduction of energy consumption.	

IP	Research Area	Specific Technological demonstration of	characteristics					Overall high level focus/objective
			Market	Testing time - YEAR start	Testing time - YEAR end	Country	TRL	
IP2	TD2.1 Advanced Communication System	markets applications	Mainline/High Speed	2021	2023	FR/DE	6/7	The demonstrators will be used to validate aspects and capabilities defined in the ACS specification documents (incl. support VoIP communication) and assess them in the context of related FRMCS specifications.
		markets applications	Urban/Suburban	2021	2023	UK	6/7	
		markets applications	Regional/Freight	2021	2023	IT	6/7	
	TD2.2 Automatic Train Operation	Demonstrate the feasibility of GoA3/4 solution on actual pilot train and line	Urban/High Speed/Regional/Freight	2022	2023	CZ	6/7	For GoA3/4, to check the behaviour of the system (ATO on board and ATO trackside) in a real pilot line.
	TD2.3 Moving Block	Higher Capacity	Urban/Suburban	2021	2022	UK	6/7	Moving Block Demonstration for Urban / Suburban, High Speed and Low traffic railway, aiming to show capacity increase on existing infrastructure, compared with traditional signalling, in lab environment
		Higher Capacity	High Speed Railways	2021	2022	DE, FR	6/7	
		Lower Cost	Low Traffic Railway	2021	2022	SE, IT	6/7	
	TD2.4 Safe Train Positioning	functional block integrated into an ERTMS based	Regional/Freight	2021	2023	IT	6	Under review for successful Fail Safe Train positioning demonstration innovative solution integrated with an ERTMS based system
		Fail-Safe Train Positioning Module	Low density traffic lines	2021	2023	Spain	4/6	
		standalone train positioning demo	All	2021	2023	DE, ES, FR, CH	4/6	
	2.5 On-board Train Integrity	On-Board Train Integrity	Low density traffic lines	2022	2022	CZ	6/7	On-Board Train Integrity, wired on-board communication
		On-Board Train Integrity	Freight	2022	2022	UK	6/7	On-Board Train Integrity, wireless on-board communication and energy harvesting
		On-Board Train Integrity	Regional	2022	2022	IT	6/7	On-Board Train Integrity, wired on-board communication, ETCS backward compatibility.
	TD2.6 Zero on-site testing	Simulation and testing environment able to support automated laboratory testing	Mainline/Regional/Freight	2021	2022	N/A	6	Corridor 1 of ETCS System could be used for verification of the testing activities with distributed test environments connected to each other from different trackside and on-board suppliers + Human Factors testing
	TD2.9 Traffic management system	Connected Driver Advisory System	Generic	2021	2022	IT	6	Prototype that implements the computation of speed profile and driving modalities to feed a Connected Driver Advisory System (C-DAS)
		Conflict Prediction System		2022	2022	CZ	6	Prototype demonstrating complex Conflict Prediction System.
		Wayside ATO constituents		2022	2022	SE, PL	6	Constituents needed for ATO GOA2 operation based on data management based on the integration Layer.
		Conflict Detection and Resolution		2020	2022	DE	6	Business service applications for the detection of future conflicts, the presentation of the results to the operator and conflict resolution measures and integration into workflow.
		Application Modules		2020	2022	DE	6	Interaction between the TMS providing indication of asset failure on the Integration Layer + selected features of Operator workstation with 3rd party application HMI
	TD2.10 Smart radio-connected all-in-all wayside objects	Verification of Wireless Low Power Object Controller	Generic	2021	2022	ES	6	Autonomous (energy power) object controller prototype to interface with ERTMS balises, signals and track circuits on areas far from stations.
Track vacancy detection SWOC		2021		2022	DE	6	Track Vacancy Detection (axle counters) with optional signal management and with safe and secured communication over wireless networks.	
Verification of Multiple Networks Scalable SWOC		2021		2023	IT	6	A prototype of wayside object controller that will be able to communicate using the available heterogeneous wireless public networks (e.g. 2G/3G/4G, satellite, ..)	
Verification of SWOC network for managing WOs demonstrator		2021		2023	NL	6	SWOC and a Wireless Sensor Network for a safe and secure communication as well as transparent routing for the IXL to the object to be controlled.	
Verification of a LX Smart wayside objects		2021		2023	CZ	6	SWOC connected via radio connection to the IXL or to the level crossing (LX) controller to control wayside objects commonly used at an LX – axle counter, gate signal, warning light, light signal or barrier drive.	
Verification of SWOC for points machines		2021		2023	ES, DE	6	Controlling of point machines with wireless communication, advanced diagnostic features, optimized distribution, low power consumption + autonomous power supply and storage	
Verification of adaptable Wireless sensor Network for way side objects		2021		2023	FR	6	New generation of low-power and resource-constrained wireless sensor networks (WSN) for adaptive data collection and forwarding for railway environment	

IP	Research Area	Specific Technological demonstration of	characteristics					Overall high level focus/objective	
			Market	Testing time - YEAR start	Testing time - YEAR end	Country	TRL		
IP3	TD3.1 Enhanced Switch & Crossing System Demonstrator	RAMS optimised S&C	Generic	2019	2023	AT	7	Monitoring programme for S&C including: Geometry and overrunning, casting, novel rail grade, resilient pads, rail fastening system, base plates, switch roller system, etc.	
		Cast manganese frog with welded bainitic component		2020	2023	FR	7	Experimental evaluation of fatigue of cast manganese-crossing for welding technology to join bainitic with pearlite steel components.	
	TD3.2 Next Generation Switch & Crossing System Demonstrator	Next Generation S&C System	Generic	2021	2023	UK	5/6	Test next generation design, control, materials and manufacturing to provide a step change in asset performance as a whole (sub)system	
		Low N&V Tramway Crossing	Urban/Suburban	2021	2023	AT	6	Test overall performance of a girder rail swing nose crossing in service for the reduction of N&V	
		Autonomous inspection of S&C using drone technology	Generic	2021	2023	UK	6	Use of drones to undertake basic visual inspection and potentially supervisor inspections of S&Cs, specifically in areas non-accessible or visible by other means	
		Autonomous repair of S&C using additive manufacturing techniques	Generic	2021	2023	UK	6	Discrete Defect repair (DDR) unit being applied to the automated restoration of worn/damaged crossings.	
		Materials and Components	Generic	2019	2023	UK, SE, FR	4/7	Next generation S&C materials and components tests (i.e. adjustable fastening systems)	
		Vertical moving switch	Mainline/Regional/Freight	2022	2023	SE	7	New vertical moving switch addressing the main issues of classic horizontal movement of the frog	
		Asphalt Track	Generic	2021	2023	UK	6/7	A site trial for demonstration to assess future assessment of asphalt performance.	
	TD3.3 Optimised Track System	Transition zone	Generic	2019	2023	SE	5/6	Tests on improvement of the transition between open track and bridges, open track and S&C, ballasted track and slab track	
		New slab track		2019	2023	SE	7	Test of a Modular Slab track solution reducing maintenance costs	
		Innovative use of materials		2019	2023	AT	5/6	Test of innovative use of materials and advanced manufacturing techniques	
		Laser clad coating on rails		2020	2023	AT	5/6	Test of laser clad coatings on rails nearby and on rail joints; laser hardening and laser cladding of worn rail zones	
	TD3.4 Next Generation Track System	Rail Defect Repair	Generic	2020	2023	UK	7	Thermocouple instrumented trials on process for different rail steel grades	
		Contactless EMAT ultrasonic defect detection		2020	2023	FR	6	Contactless ultrasonic method to identify rail level defects using the EMAT method	
	TD3.5 Proactive Bridge and Tunnel Assessment, Repair and Upgrade Demonstrator	Tunnel improvements	Generic	2020	2023	FR, UK	7	Reduce track and tunnel closure by offsite manufacturing and increase quality	
				2020	2023	AT	7	Predict calcite clogging over time	
		Bridge improvements	Generic	Urban/Suburban	2020	2023	DE	6	Efficient monitoring of noise emission and installation of passive noise dampers.
				2020	2023	UK	7	Extend bridge service life by lowering fatigue	
				2021	2023	SE	7	Increase bearing capacity and remaining fatigue life of concrete bridges and increasing safety.	
High Speed	2020	2023	SE	7	Make high speed traffic possible on existing bridges with proven dynamic properties				
Integrated Technological Demonstrators Asset Management (TD3.6, TD3.7, TD3.8)	Strategic long-term	Generic	2021	2023	PT, UK	6	Test of a strategic decision support tool based on the tactical planning tool		
	Tactical and Operational short term		2021	2023	UK, SE, DE, NL, ES, FR	6/7	Maintenance process and strategies through knowledge extracted from information coming from available data and monitoring systems		
	Metro/Tram Asset Management	Urban/Suburban	2021	2022	IT	7	Demonstrator focusing on minimising maintenance costs, optimising the use of resources while maximising network		
TD3.9 Smart Power Supply Demonstrator	SMART Control of Rail Power Supply	Electric Railways all Systems	2020	2022	DE	7	Demonstration of functionality, capacity, application and integration in the systems.		

IP	Research Area	Specific Technological demonstration of	characteristics					Overall high level focus/objective
			Market	Testing time - YEAR start	Testing time - YEAR end	Country	TRL	
IP4	Integrated TDs of all IP4 ecosystem	Towards the MaaS concept	Shared modes and on-demand	2022	2023	GR, IT, FI, CZ	6/7	Test of a scalable eco-systems which enables pan European multimodal travels and MaaS. Demonstration of the functional ecosystem with the full integration of Ride-sharing and MaaS. Scalable (near-) market ready eco-systems enables pan European intermodal travels and MaaS, including cross-platform approaches.
		Fully dynamic door-to-door travel	Multimodal (rail, bus, metro,...)	2022	2023	IT, GR, HR, ES, CZ, PL	6/7	Demonstrations of IP4 technologies in 6 different locations involving different transport operators, translating/combining IP4 solutions into specific demo sites solutions:

IP	Research Area	Specific Technological demonstration of	characteristics					Overall high level focus/objective
			Market	Testing time - YEAR start	Testing time - YEAR end	Country	TRL	
IP5	TD5.1 Fleet Digitalization and Automation	Automatic coupling	Freight	2020	2022	SE	6/7	Telematics and electrification, digital automatic coupling of TD5.1 will be tested. Test in extreme winter conditions. These testing activities will contribute to the compilation of enough evidence so final EU DAC Product specification can be standardised and safety/interoperability requirements updated in the TSI
		Condition based maintenance		2020	2023	DE	6/7	End-to-end solution for predictive maintenance, including processes, data handling, analytics and dashboards, for locomotives and wagons.
	TD5.2 Digital Transport Management	Improved terminals		2021	2022	SE	6	A gate equipped with intelligence as part of a connected decision platform optimizing the work process in a terminal. Sata exchange platform to ensure efficiency and security (of data handling) in the transport chain. Equipment prototypes with HMI interface validated in live demonstration for a selected large and complex terminal.
	TD5.3 Smart Freight Wagon Concepts	Core market wagon		2022	2023	SK	7	Modular, logistics-capable and cost-efficient, low weight, high-payload and aerodynamically optimised freight wagons
		Extended Market Wagon		2022	2023	CZ	5/6	Modular, logistics-capable and cost-efficient, low weight, high-payload and aerodynamically optimised freight wagons
		Telematics		2021	2023	SE	7	Demonstration activities of the intelligent wagon based on telematics and electrification
	TD5.4 New Freight Propulsion Concepts	Hybrid / advanced Propulsion		2021	2022	DE, SE	6/7	Demonstration of distributed power (3 Locos) technology developed using LTE with a 700 m heavy coal freight train with loco at the end of the train being remote controlled. Second demonstrator 835 m train.

1.2.1. IP1 Cost-efficient and Reliable Trains, including high-capacity trains and high-speed trains

The picture below gives a visual perception on where the TDs will introduce improvements.

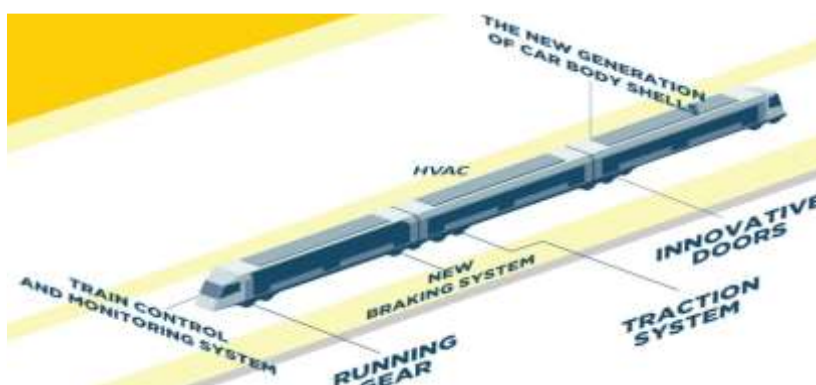

TD 1.1. Traction systems Demonstrator

The TD develops new traction components and subsystems using mainly silicon carbide (SiC) technologies leading to new architectures. The activities aim at producing SiC Technology Demonstrators to be

implemented into tramway, metro, sub-urban train, regional train as well as a traction system based on independently rotating wheels to be demonstrated on a high-speed train.

The SiC application opens up many improvements in Key Performance Indicators (Life Cycle Cost and technical). Besides improved energy efficiency and maintenance costs, it gives additional optimisation possibilities enhancing customer value, such as noise reduction and efficient cooling.

TD progress

Significant progress has been achieved during 2022. Details are given below.

The main objective for 2022 was the preparation and/or the on-train demonstration of prototypes of Traction components at TRL7. The work carried out in 2022 has brought the following main results:

- continuation of the metro SiC-based Traction components demonstration, which will last until mid-2023. The actual results are satisfactory in terms of energy and maintenance costs reduction, increase on reliability as well as in weight and noise reduction when the SiC based converter has been tested.
- For sub-urban demonstrator, lab tests were performed on a sub-urban SiC based traction system including a new traction motor (with low rotor resistance for low fundamental loss) and a new line and motor converters (for single axle drive configuration).
- Finalisation (in Q1 2022) of SiC based Traction system (transformer, traction case, motor and gearbox) demonstration on regional trains. The tests took place in the VUZ test center (Velim, CZ).
- On High-speed train (HST), the test on static bench of a wheel motor prototype has been done and the motor will be tested on a train in the first half of 2023.

The 7 KPIs linked to the Traction TD have been updated: The KPIs progress confirms that most of the targets defined for the end of S2R are achieved and the train manufacturers confirm the viability of the SiC technology for a rapid commercial deployment on Traction systems (the SiC technology has started to be sold on other train components like auxiliary converters or DC/DC interface for hybrid trains). The table below is updated with the latest KPIs results as they are provided by the different companies contributing to the traction demos. The main benefits of the newly developed traction systems are described in the following chart.

Train/application	Development partner	LCC reduction			Reliability		Train Capacity		Line Capacity	
		Cost	Energy Cost	Maintenance Cost	Reliability	Weight Reduction	Volume Reduction	Noise reduction		
Tramway	Siemens	0%	-10%	-5%	5%	-10%	-10%	Reduction of noise tonality		
Metro	CAF	2%	-7%	-7%	6%	-25%	-25%	-3%		
Sub-urban	BT	2%	-8%	-21%	31%	-10%	-20%	-10%		
Regional	Alstom	2%	-13%	-14%	11%	-17%	-5%	-1%		
High Speed	Talgo	2%	-4%	-5%	12%	-3%	-2%	0%		
Application	Development partner	Cost	Energy Cost	Maintenance Cost	Reliability	Weight Reduction	Volume Reduction	Noise reduction		
HVAC - Regional	DB+	20%	-6%	20%	0%	15%	0%	0%		

The figures in % are representing progress compared to the classical Si Traction baselines (tramway, metro, sub-urban, regional trains). The accuracy of quantification is described from 1 to 4, as defined at S2R level by the project IMPACT-2, responsible for the consolidation of KPIs at S2R Programme level. 1 is expert estimation; 4 are demonstrated on a train.

The main point to be underlined is that major energy savings have been demonstrated. This opens the path toward less CO₂ trains emissions, both for electric trains and diesel-electric trains, as the SiC technology can be used in all train types. The SiC technology is a good solution to better fight climate change and

opens up promising possibilities for further R&D action in the next decade, if this technology is used for decarbonised alternative Traction systems like Hydrogen hybrid or Batteries-powered trains.

Links to other national or European entities like Clean Hydrogen JU, Batt4EU or Eurospecs (Battery trains and Energy Storage Systems) have been established to underline complementarity between their work. Many results will be used also in the EU-Rail FP4-Rail4Earth Project dealing with “green and sustainable railways”.

On virtual validation and certification, the application of virtual design and validation methodologies achieved important gains on Traction system validation costs (-9%) and time saving (-8%).

This field of research, in the Digitalisation of railways, will bring very significant commercial projects benefits. Further work and discussions (both technical and normative) are already scheduled in EU-Rail JU FP4-Rail4Earth Project.

The Traction TD is progressing almost according to schedule, Talgo will finalise its wheel-motor demonstration in 2023.

The availability of power semi-conductors at affordable price is still a topic to be considered carefully and having a credible supplier in Europe would be positive in terms of price reduction.

TD1.1 Traction Systems Demonstrator									
2015	2016	2017	2018	2019	2020	2021	2022	2023	...
Finished: Roll2Rail, PINTA, PINTA2						Ongoing: PINTA3, RECET4Rail			

During 2022, 17 deliverables were planned out of which 11 were released. The reports pending were replanned due to extension of technical work. TD1.1 has reported having accomplished 90% of the planned work up to the end of 2022, which represents around 90% of the overall TD.

TD 1.2. Train control and monitoring system (TCMS)

The development of a Next Generation Train Control and Monitoring System (NG-TCMS) will allow overcoming current bottlenecks caused by physically coupled trains. The new drive-by-data concept for train control, along with wireless information transmission, aims at making new control functions possible; it involves interaction between vehicles and consists, providing high safety and reliability levels with very simple physical architectures.

TD Progress

The TD1.2 builds on the progress made by CONNECTA and Safe4Rail in the first phase, and the work made by CONNECTA-2 and Safe4RAIL-2 projects in the second phase, which have been completed in 2021. In December 2020, the projects CONNECTA-3 and Safe4RAIL-3 were launched with the objective to reach high TRL in the technologies introduced in the NG-TCMS.

After having reached in the first phase of the projects the definition of general specifications for the NG-TCMS, including a comprehensive list of use cases and the corresponding high level system architecture, the prototypes made in 2020 based on those specifications have been tested and validated throughout 2022. The laboratory test execution has served to overcoming some gaps and specification mistakes made in the CONNECTA project, resulting in a specification update publicly available in the CONNECTA-2 project website. The achieved degree of maturity in prototypes will allow the implementation and deployment of NG-TCMS technologies in the high TRL demonstrators expected in the CONNECTA-3 project (up to TRL 6/7).

The main objective of 2022 was the scalation of pillar technologies to higher TRL levels in order to integrate them in the relevant urban and regional demonstrators. Within this process, the following achievements and findings have been reached:

- The signal-based Functional Distributed Framework (FDF) for SIL2 applications has been developed using the SIL2 life cycle and the required validation tests.

- The signal-based FDF for SIL4 architecture has been specified using 1oo2 scheme. Two channels have been synchronized using onboard Ethernet TSN 802.1AS protocol. This FDF is being developed with a TRL4/5 considering the TCMS market is not yet demanding SIL4 applications.
- The service-oriented FDF based on Autosar AP to be used in the regional demonstrator has been discarded and will not be used in CONNECTA-3. The reason behind is the lack of deterministic execution function for Autosar AP within the Autosar foundation's roadmap.
- In order not to jeopardize the rest of the technologies in the regional demonstrator, a new FDF simulator will be developed by CONNECTA-3 members.
- The Simulation Frameworks (SF) allowing software and hardware in the loop simulations have been configured and complemented in order to create relevant laboratory environments for both demonstrators to test over them the pillar technologies of the NG-TCMS.
- The Drive by Data (DbD) tests failed in CONNECTA-2 for TSN features. The tests that failed in CONNECTA-2 for wireless inauguration have been successfully repeated between CONNECTA-3 and Safe4Rail-3. The wireless inauguration specification has been also extended to include the neighbouring discovery using RFID sensors and to include the multidomain approach of the wireless train backbone.
- New application profiles for consist-level and train-level communications have been specified for traction, brakes, lighting, ATO GoA4 and Fire Detection System. This work will continue in 2023.
- For the Train to Ground (T2G) communications, a new service for the IEC 61375-2-6 is being developed: video streaming service.
- Safe4Rail-3 has performed studies related to antenna installation using ray tracing simulation techniques for all wireless communications applicable to NG-TCMS: train-to-ground, Wireless Train Backbone and Wireless Consist Network.

TD1.2 has continued in 2022 the cooperation with OCORA and has actively participated in the ERA Topical Working Group Architecture (TWG ARCHI), together with LinX4Rail, on the topics related to a One Common Bus.

The overall progress is in line with the plan established in the Multi-Annual Action Plan. TD1.2 has experienced some delays due to issue in the electronics supply chains. Nevertheless, these problems have been already solved and the contingency plans applied have limited the impact on the demonstrators. The work accomplished throughout year paves the way to complete successfully the High TRL Demonstrators foreseen in 2023.

TD1.2 Train Control and Monitoring System Demonstrator									
2015	2016	2017	2018	2019	2020	2021	2022	2023	...
Finished: Roll2Rail, CONNECTA, SAFE4RAIL, CONNECTA2, SAFE4RAIL2						Ongoing: CONNECTA3, SAFE4RAIL3			

In 2022, the overall progress is in line with the plan. Out of the 9 deliverables expected in 2022, 6 have been delivered. TD 1.2 have accomplished around 90% of the planned work up to end of 2022, which represents 78% of the overall TD progress.

TD 1.3 Car body shell

The new generation of car body shells using composite or other lightweight materials will lead to significantly lighter vehicles that carry more passengers within the same axle load constraints, using less energy and reducing impact on rail infrastructure.

TD Progress

The TD1.3 builds on the progress made by the completed projects Roll2Rail, Mat4Rail and PIVOT, and developments currently continue in the projects PIVOT2 and GEARBODIES.

In 2022, the TD1.3 has been focused on manufacturing the subcomponents of the different demonstrators using all the moulds and manufacturing engineering developed the past year.

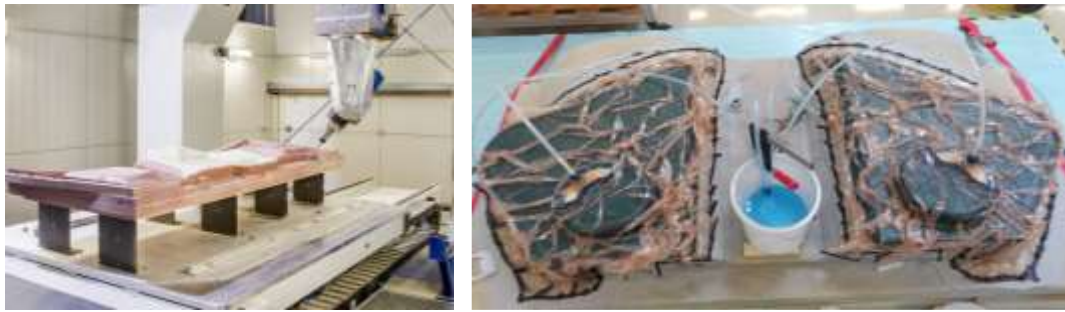

Moulding/tooling manufacturing 2022 (left). Infusion process for component manufacturing 2022 (right).



Infusion process for component manufacturing 2022 (left). Component under machining process 2022 (right).



Component of headstock demo during manufacturing 2022 (left). High-Speed carbody demo prior to the final assembly 2022 (right).

The manufacturing of the demo was achieved proving the reductions in weight following previous assumptions (PIVOT Project) and the results show that the reduction in weight is greater than 20% in all the cases. TD1.3 has continued its active contribution to the activities of the working group in CEN/TC 256/SC 2/WG 54 for standardization composites materials aiming to establish a new “Process standard for the introduction of new materials”.

TD1.3 Carbody Shell Demonstrator									
2015	2016	2017	2018	2019	2020	2021	2022	2023	...
Finished: Roll2Rail, Mat4Rail, PIVOT				Ongoing: PIVOT2, CARBODIN, GEARBODIES					

During 2022, a section of the carbody in composite material has been presented at InnoTrans 2022 for visitors to witness the possibilities of using alternative materials in the railway industry. TD 1.3 has reported having accomplished 81% of the planned work up to the end of 2022, which represents 70% of the overall TD. Out of the 17 deliverables expected in 2022 only 6 have been delivered, which is reflected on the overall progress of the TD.



Section High-Speed carbody & TD1.4 Running Gear demo presentation at InnoTrans 2022

The demonstrators are under preparation for final integration and completion of the testing phase at the beginning of 2023.

TD 1.4 Running gear

TD1.4 continues to work on innovative developments of new architectural concepts, new actuators in a new lighter wheelset, frame and other components, leading to innovative functionalities and improved efficiency and performance levels.

The TD1.4 builds on the progress made in 2022 by the project PIVOT2, GEARBODIES and NEXTGEAR.

Sensor and health monitoring functionality

The development of the different health monitoring systems for condition-based maintenance has continued. Regarding onboard solutions, a Bogie Component Health Monitoring based on Machine Learning Techniques has been developed. These algorithms have been tested both offline and online. Additionally, a dashboard has been developed focusing on improving the user experience. On the other hand, a thermal monitoring system (TheMoS) has been implemented in RENFE S102/S112 Trainset, in collaboration with Malaga and Santa Catalina Maintenance Depot. Thanks to this collaboration with the end users, adjustments and adaptations of the rules and algorithms have been made, with the aim of fine-tuning the detection of anomalies in running gear components, such as Bearings, Comfort Accelerations and Train Guidance. In this way, TheMoS platform has become the CBM tool for managing Running Gear at Maintenance Depot. Finally, an unsupervised vehicle running instability detection algorithm (iVRIDA) is developed in collaborative efforts of KTH, Trafikverket, and CAF. The algorithm was first developed with simulated vehicle accelerations, later validated with measurements of high-speed vehicle.

With regard to wayside systems, data analysis has been carried out using the information obtained from the prototype installed and developed in a real track. The analysis has been focused on flats, ovalisation and primary suspension elements. Initial results show the feasibility of these type of systems.

Finally, hardware solutions (3ax accelerometer, sensor gateway) have been further developed and tested (lab and environmental tests) with the aim to ease the implementation of these systems in real environments.

Active Suspension and control technology

Along other developments for active steering, a hydro elastic bush has been studied, produced, and tested, together with an electrical guiding system for high-speed train application. The aim is to improve curve steering (less friction in curves) without impeding stability on tangent track. After an economic study to define the adequate trainset to be first equipped, dynamic simulations were performed, and the necessary parts were specified and ordered. The system has been manufactured, assembled, and validated (with the help of virtual certification, see below). The system is currently tested on SNCF commercial trains.

Noise and Vibration reduction

These activities rely a lot on testing. During the pandemic, testing opportunities were very limited. However, an initial assessment has been launched to study the effect of novel lightweight materials and active suspensions systems and an optimisation strategy for controlling the structure-borne noise transmission through a transmission path test campaign. To compute both factors (metal and lightweight material), the acceleration Frequency Response Functions (FRFs) of the running gear are obtained through three measurement campaigns were performed on each structure. The results show the lightweight has higher values of transmissibility than the metallic one, in the measured frequency spectra. Thus, it is predicted that, having the same input force on the wheel, the lightweight generates more noise than the metallic one.

Thanks to its physical background and generality, the methodology is applicable to different kind of vehicles methodology for the analysis of structure-borne vibration in railway vehicles.

Optimised Materials

The prototype of the composite frame for an independent rotating wheel running gear was produced. A weight reduction of 46% for the whole frame was achieved. Static test according to EN 13749 has been finished successfully with also a good correlation between model and reality. NDT method like ultrasonic inspection has shown the potential for maintenance application for monolithic structures. Standard fatigue testing compliant to EN 13749 until 10 million cycles was completed and after the standardized test, ultimate loads from static have been tested without damage. The lightweight running gear frame has been presented in JEC Conferences in Paris and InnoTrans in Berlin.

The long-term field test of the light-weight axle with the freight application prototype was completed after one year of testing. Subsequently, the prototype axle was dismantled and the inspection is currently ongoing.

The manufacturing process and the qualification process of the lightweight axle system were elaborated, and a qualification test body was designed. The test body is generally equivalent to a wheelset for metro application. The test body was produced and a test run with three load levels was performed on a bending test bench. The test body successfully passed the test with load levels higher than applied for common wheelsets. Currently, the test body is inspected, and the test run is in its final phase.

The novel single axle composite running gear frame developed in PIVOT2 and NEXTGEAR has proven to enable substantial weight reductions for lightweight rail vehicles. The question of life cycle performance of the component has been further investigated. A thorough work on the life cycle cost for composites in rail vehicles is ongoing with a focus on how to apply the knowledge already in the design phase of composite rail vehicle components. This includes analyses of material extraction and processing, appropriate composites manufacturing methods for rail vehicle components, use phase impact and recycling scenarios of the components.

With the aim to reduce LCC for running gear parts, rubber material parts are under investigation. A selection process was performed in a collaboration environment using an Analytic Hierarchy Process (AHP). The final choice was made about the two running-gear components to be prototyped: 1) Conical Spring in primary suspension; and 2) Bushing in longitudinal swingarm.

As the next steps in the process, the formulation of the new elastomer, based on the addition of carbon micro nanotubes, and selection of the rubber can get started, as well as the elastomer-metal interfaces design and the preparation of the testing plan.

Virtual certification

The methods currently used in the railway sector and assessment of current methodology was investigated following the guidelines established by EN 14363:2016. In 2022, activities focused on defining a concrete application for the identified improvements: new ways to address over-speed and over-cant deficiency, combination of several methodology of validation, ways to manage friction coefficient and rail profile, definition of an universal format to exchange input data. Each of these subjects will facilitate the current process to allow virtual testing. Concrete application of virtual testing has been successfully used to justify commercial tests for hydro-elastics bushings developed.

Universal Cost model 2.0

The Open Call project NextGear completed their WP on 'Universal Cost model 2.0' in 2022. NextGear has delivered for review to PIVOT2 the UCM tool, the user manual and the simulation guidelines. Exchanges and feedback were provided to NextGear. A validation report including all of the review comments has been provided to NextGear. NextGear has addressed most concerns from the validation report with the remaining open points being discussed in bilateral meetings between NextGear and PIVOT2.

During 2022, the work has continued within the task 'UCM2.0 evolution validation support'. Validation case studies have been done to check the UCM's performance and usability. However, considering limited resources, only a part of the UCM 2.0 could be validated. The final report on this task will be delivered at the beginning of 2023.

TD1.4 Running Gear Demonstrator								
2015	2016	2017	2018	2019	2020	2021	2022	2023
Finished: Roll2Rail, Run2Rail, PIVOT				Ongoing: PIVOT2, NEXTGEAR, GEARBODIES				

During 2022, out of the 13 deliverables expected, only 5 have been delivered mainly due to the delays incurred within WP7 and WP8 in PIVOT2. TD 1.4 has reported having accomplished 80% of the planned work up to end of 2022, which is estimated to represent 79% of the overall TD.

TD 1.5 Brakes

The main objective of Technical Demonstrator 1.5 Brakes is to develop novel braking systems and contribute to the achievement of overall JU's mission of increasing the attractiveness of railway by:

- improving the performance, reliability and punctuality,
- increasing line capacity,
- reducing lifecycle costs.

Building on the results achieved by the already completed projects Roll2Rail, CONNECTA, PINTA, PINTA2 and PIVOT, the focus of TD Brakes in 2022, in projects PIVOT2 and CONNECTA-3, was on developing innovative solutions in five areas:

1. Ability to implement brake control functions on electronic platform compliant with safety integrity level SIL 3 and 4,
2. Innovative friction pairing solutions to reduce noise and dust emissions,
3. Electro-mechanic braking system to replace conventional pneumatic and hydraulic technology,
4. Methods and tools for virtual validation and certification of braking system,
5. Improved adhesion management systems for traction and braking; improved virtual testing for WSP systems.

TD Progress

High SIL electronics

To ensure the safety of passengers and goods and achieve the required safety integrity level (up to SIL4) for certain braking functions, modern railway vehicles rely on conventional technology, i.e. pneumatic signals and brake control. The development of an electronic brake control function compliant with high-safety integrity level (SIL3/SIL4) will provide more accurate control and reduction of overall vehicle weight.

After successfully performing laboratory tests in 2020, the task force has installed and validated newly developed high-SIL braking system as a field demonstrator in 2022. The demonstration was done in close cooperation with EUSKOTREN that provided the train. Together with a simplified architecture for weighed emergency brake, a novel strategy for distribution of braking force along the train was implemented to optimize the brake's performance in low adhesion conditions. The system has been proved during operational conditions, in terms of performances and safety level, and has been qualified with a Notified Body (NoBo). It is today in operational service on passenger train.

Innovative friction pairings

This research area focuses on the development and design of a new generation of disc and friction material to reduce noise and braking dust and improve braking performance. Furthermore, by reducing the wear of the materials, a longer lifetime is possible, which reduces LCC costs.

In 2022 the activities related to the friction pair development were focussed on test and validation in field of the prototypes which have been developed. The tests at dynamometer have been carried out and completed in 2021. In addition to fundamental tests related to the evaluation of friction and wear performance of the brake discs and pads pairs, exhaustive tests have been carried out with a strong focus on the environmental criteria of brake dust and noise emissions, following the goal of the full validation of the developed eco-friendly friction pair.

Of the two tested friction pair prototypes, only one could be validated in lab and was able to exhibit a good braking performance with low specific wear, rounded off by significant results related to the environmental characteristics:

- a reduction of approx. 75% for PM10, 83% for PM2.5 and 94% for PM1 related to brake dust emission and;
- a reduction of approx. 2,1% related to brake noise emission in terms of equivalent continuous A-weighted sound pressure in dB(A) averaged over all the characterized brake events as well as a maximum reduction of approx. 21% under specific test conditions in comparison with the commercial friction pair tested as reference.

Dynamometer tests results have been fully evaluated and extensively reported in the deliverable “Friction Pairing – Prototype implementation and test report”.

After the validation in lab of an eco-friendly friction pair showing strong emissions reduction in comparison to a commercial friction pair by equivalent friction and wear performance, the validation in service of the new prototype was necessary. This final development step has been carried out during the summer 2022 with the support of the Italian railway operator Trenord. The field test has been carried out on three friction pair prototypes mounted on the same axle of a trailer bogie of a regional vehicle. The results of three measurements campaigns showed a proper operation in service as well as a good wear performance of the installed friction pair prototypes. Hence, the full validation of the innovative, eco-friendly friction pair has been thoroughly finalised and the results of the field test reported in detail.

Electro-mechanic braking system

Currently, railway vehicles deploy either pneumatic braking system in form of purely pneumatic systems, electro-pneumatic system or electronically controlled pneumatic braking systems. Technological trends like electrification and the vision of airless train together with the urge to reduce vehicle weight and lifecycles costs drive the development of an electro-mechanic solution. Effective transfer of braking signal, better diagnostics and fewer components and, thus, significant reduction of system weight, energy consumption and lifecycle costs are just some of the advantages of electro-mechanic braking systems.

In 2022, the technical work EM Brake System Description was published. This system description of the electro-mechanic braking system describes the braking functions on train level and includes the features of existing and possible electro-mechanic braking concepts and considers the integration aspects from the vehicle builder and from the brake supplier view. The differences between air brake systems today and the electro mechanic brake systems are pointed out.

During 2022, the concept for electro-mechanical brake has been proved against the operational requirements demonstrating its capability to execute the traditional braking functions (parking, service, weighed emergency) that are currently implemented by pneumatic systems.

Virtual validation and certification

One of the major cost drivers for the authorization of braking systems currently stems from the necessity to perform comprehensive laboratory and on-train tests as a final validation of the system performance.

Building on the work of Roll2Rail and PIVOT, the main objective of this task is to propose improvements to reduce homologation costs and shorten the time necessary for putting rail vehicles in service by using simulation.

In 2021, the TD developed a simulator implementing the specification elaborated in 2020 for demonstration purposes. In 2022, the resulting data of the simulator for demonstration purposes have been compared with existing commissioning field test data. Furthermore, the work concerning CSM-RA that has been started in 2021 has been continued by independent assessment body.

Adhesion management

Unpredictable physical phenomena in wheel-rail contact make exact determination of braking distance very difficult and hinder all efforts in increasing capacity by taking sufficient braking distance reserves into account. The main objective of this task is the development of solutions (and testing methods) capable of better management of adhesion condition variation to significantly reduce braking distance and torsional vibration during traction and increase capacity and punctuality.

In 2022, the main focus of the collaborative work was related to the consideration of wheel/rail adhesion in ATO and ETCS operation/standards. In addition to technical exchanges with several external groups (e.g. signalling experts) dealing with this topic, the group worked on definitions that are technically feasible from brakes/traction point of view. These were on the one hand the definition of adhesion categories to be used for ATO/ETCS, as well as methods to determine the wheel/rail adhesion that is currently available on the track.

Furthermore, test runs using the DB advanced TrainLab (aTL) were conducted. The test runs which were prepared in 2021 comprised the train integration and test of a technical software solution for optimised utilisation of available adhesion (WSP system) and a solution for influencing the braking at low adhesion conditions using means for improvement, as distributed sanding systems. This was done at TRL6/7 (in relevant operational environment). In addition, basic tests on the influence of the MTB on the rail condition were performed. Overall, the tests resulted in a total of 333 test data sets which are partly analysed already. Considerations on what conclusions will be given into the group's so-called adhesion catalogue have started already but will be continued next year.

Following the successful laboratory trials, the developed adhesion management solutions have been installed on a train (EUSKOTREN) and tested in operational conditions. In case of track presenting degraded adhesion, at various level, the system demonstrated improvements in terms of stopping distances, efficiency to prevent wheel flats and repeatability of performances. The solution is today in operational service (on a passenger train).

TD1.5 Brake Systems Demonstrator									
2015	2016	2017	2018	2019	2020	2021	2022	2023	...
Finished: Roll2Rail, CONNECTA, SAFE4RAIL, PINTA, PIVOT, PINTA2						Ongoing: PIVOT2, CONNECTA-3			

During 2022, TD1.5 has reported having accomplished 100% of the planned work up to year end which is estimated to represent 88% of the overall TD. Out of the 6 deliverables expected in 2022, all the 6 were delivered. By mid-2023, TD1.5 Brakes is expected to deliver 6 demonstrators of TRL 4-6:

- Full brake system including new generation high SIL brake control equipment (on field demonstrator),
- Innovative friction pairing solution (on field demonstrator),
- Field test of adhesion management solutions,
- Field test with EM brake (one bogie),
- EM brake solution completely hydraulic-free (laboratory validated prototype),
- Laboratory-validated demonstrator for virtual validation and certification.

TD 1.6 Doors and Access Systems Demonstrator

The challenge of the TD is to provide the public with seamless, flexible and safe access to the train, including persons with reduced mobility, in addition to improving comfort features like noise and thermal

insulation. On top of that, this TD is bringing more functionality to the door and access systems toward self-managed and autonomous door for automated train operations up until GoA4. Everything must be done taking into account cost and weight constraints.

TD Progress

The TD1.6 builds upon the progress made by the PIVOT2 and CARBODIN projects.

Door leaves design for acoustic attenuation, thermal insulation and weight reduction

Metallic door leaves: In 2022, the work focused on the manufacturing and on the validation tests of the door leaves. This new design was developed around the use of the new type of structural profiles for thermal insulation and the innovative filling for acoustic attenuation in the new structure of the door leaves (complex arrangement of rigid and flexible materials inside the door leaves instead of rigid foam). The prototypes were manufactured, and the performance tests were finished at the end of 2022. In the meantime, Carbodin studied a more complex acoustic solution based on Helmholtz resonators.



Bonding of the insulated pillars (left). Innovative filling material (right).

Composite door leaves: In 2022, PIVOT2 activities mainly concerned the manufacturing of the composite door leaves using a tooling directly purchased by the S2R JU. PIVOT2 performed different attempts to deliver 100 % compliant door leaves and aimed to finalize the adjustment of the press molding process in early 2023. In the meantime, Carbodin studied an alternative design based on infusion process.



Composite part (left). Composite door leaf (right).

Accessibility

In 2022, PIVOT2 performed detailed studies on the improvement of the door threshold for sliding doors, reducing offsets and removing slopes between the tread of the bridging plate and the vestibule floor. The door sealing is also considered in the study for acoustic attenuation. In the meantime, PIVOT2 will finish to test an improved bridging plate.



Bridging plate on the vibration test bench

Door surveillance and safety

In 2022, PIVOT2 has continued developing a laser sensor on the inner faces of door leaves for touchless detection of passengers and obstacles between the door leaves.



View of laser scanner for touchless obstacle detection

A camera was also implemented on the external face of the vehicle centered above the door. Thanks to a collaboration with Euskotren, the experiment in revenue service started in November 2021 aiming first at validating the touchless passenger and obstacle detection with the laser sensor and, secondly, at collecting videos. Although the collection of videos to check and improve the algorithms for the functions like platform detection, platform position measurement, virtual pushbutton, contactless obstacle detection, passenger detection on bridging plates or ramps, and surveillance of the door area during train departure, are not yet enforced due to legal and technical difficulties.



View of camera centred above the door

Integrated door and demonstration

PIVOT2 has assembled a mock-up of a single sliding plug door and performed functional and endurance tests.

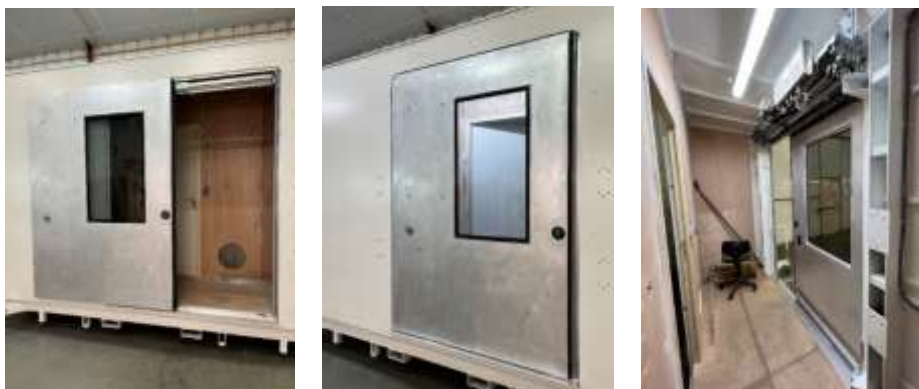

1400 mm sliding plug door

The last mock-up of double sliding plug doors with metallic door leaves has been implemented in 2022 on an SNCF static train and tests were successfully performed. The opposite door is waiting for the composite door leaves.



Door mounted on a static SNCF train equipped with door leaves, swinging arm and handles developed with PIVOT2

TD1.6 Doors and Access Systems Demonstrator									
2015	2016	2017	2018	2019	2020	2021	2022	2023	...
			Finished: PIVOT			Ongoing: PIVOT2, CARBODIN			

In 2022, TD1.6 has reported having accomplished 100% of the planned work up to year end, which is estimated to represent about 86% of the overall TD. Out of the 6 deliverables expected in 2022, all the 6 of them have been delivered.

TD 1.7 Train Modularity in Use (TMIU)

The TD develops new modular concepts for train interiors (face and roof) that allow operators to adapt the vehicle layout and atmosphere to the actual usage conditions more quickly and at a lower cost. The objective is to provide the operators with better opportunities of being flexible to the demand and reducing the global cost and the global time to integrate new interiors.

The TD also includes rethinking the driver's cabin to be more compact and evolutive, less costly and more human-centred. It is a prospective design for new driving which impacts the space, the use, and the technologies.

TD Progress in 2022

The TD1.7 builds on the progress made by PIVOT2.

INTERIORS

Following the ideation phase, two concepts have been developed with the aim of reducing by half the global cost:

- Concept 1: consists of two visible beams inside the passenger's room with predefined fixing points to fix equipment using mounting brackets. It is composed of simple panel shapes to reduce the cost and incorporates electric layer to power and help to evolve the interiors without cabling.
- Concept 2: consists of two visible bars inside the passenger's room with new fasteners to fix with full free-positioning equipment. The panel shapes are designed to reduce the number of pieces and the panels also incorporate electric layer to power and help the evolution of the interiors without cabling.

2022 was the year of finalisation of the studies and the year dedicated to produce the demonstrators. The final results show a decrease of around 43% in time and cost consumption and 47% reduction in the number of parts. In September 2022, a physical mock-up scale was shown at InnoTrans 2022 to demonstrate the concepts and a demonstrator was also produced to explain the concepts described with 3D animations.

CABIN

Following the technical analysis and European survey done in 2020 and 2021, the prospective design of new driver's cabin has been finalised with three new concepts:

1. **Adaptative Cocoon:** consists of a compact driver's cabin in the front of the train specifically designed for dual mode of driving (seating position of autonomous operation GOA2 and sitting position for manual operation GOA1 only when needed) and driving assist by tactile and head of display technologies.
2. **Immersive Chair:** consists of a compact driver's mono-cabin integrated anywhere in the train and specifically designed for full digital driving mode without "natural" outside visibility and with a specific multifunctional desk-seat.
3. **Panoramic Cabin:** consists of a compact driver's mono-cabin located on top of the train allowing additional room for passengers along the surface of the vehicle. The cabin incorporates driving assistance for the driver (specifically for operations at stations).

The year 2022 was the year of finalisation of the development of the concepts and its assembly once all data since the start of the Project PIVOT2 was collected. The challenge was also to produce the demonstrator (3D animation) on time for InnoTrans 2022.

TD1.7 Train Modularity In Use (TMIU)									
2015	2016	2017	2018	2019	2020	2021	2022	2023	...
Finished: Roll2Rail, Mat4Rail, PIVOT					Ongoing: PIVOT2, CARBODIN				

In 2022, TD1.7 has reported having accomplished 85% of the planned work up to year end, which is estimated to represent about 75% of the overall TD. Out of the 14 deliverables expected in 2022, 10 have been delivered.

Three final demonstrators have been produced for InnoTrans 2022: one physical mock-up to test new interiors (face and roof), one immersive mock-up (virtual) of 2 complete concepts of Interiors, and one immersive mock-up (virtual) of three prospective concepts of driver's cabin.

TD 1.8 HVAC

Conventional "Heating, Ventilation Air Conditioning and Cooling" systems (HVAC) within rail vehicles use artificial refrigerants that have a very high impact on global warming (e.g. R134a). In order to limit the

climatic impact from HVAC systems, the European Union introduced in the 2014 regulation No 517/2014 which aims to reduce the use of artificial refrigerants within the EU according to a fixed time schedule. Consequently, there is a strong need to develop HVACs using natural refrigerants such as air or CO₂.

Within TD1.8 two HVAC demonstrators with the natural refrigerant CO₂ were specified, developed and tested in laboratory as well as in commercial operation (TRL7). At the end of the project these HVAC units are ready for application within new trains as well as for the refurbishment of existing trains.

Additional activities included the pre-standardisation of mechanical, electrical and control interfaces of HVAC units. A standardisation of HVAC interfaces is important to prevent the adoption of HVAC units for every vehicle class, increase the number of similar units, reduce the costs, and allow a simpler refurbishment.

The activities are carried out within the PIVOT2 and PINTA3 projects.

TD Progress

In December 2022, the demonstration activities within the TD had been successfully performed. Both HVAC units have passed the field test in real operation in South Germany:

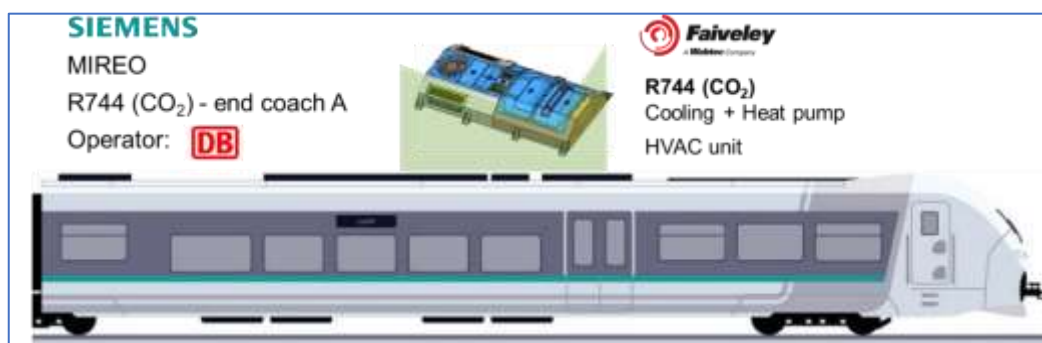

HVAC unit mounted on a single-deck regional train



HVAC units mounted on a double-deck regional train

The test results have shown that it is possible to achieve the same thermal comfort using an HVAC unit with the natural refrigerant CO₂ to replace artificial refrigerants. Both units have passed the field test without major failures. Beside the new refrigerant, in both units a heat pump was integrated. This reduces the energy consumption in relation to state-of-the-art units with electrical heating. In contrast to artificial refrigerants of today, natural refrigerant as CO₂ or Propane allows a heat pump operation down to -10-15°C. The climatic chamber tests have shown that the yearly energy consumption of the CO₂ HVAC units can be reduced in the order of 7% for climatic zone 2 (central Europe). In North Europe the savings are even higher. Today, a reduced energy consumption is very important due to the increased energy prices and the application in battery and fuel cell trains to increase their operational range.

The drawback of the refrigerant CO₂ and integrated heat pump are increased weight and capital costs (+ 10 to 15%) due to the higher working pressure and the additional needed components of the refrigerant circuit. But the higher cost can be partly compensated by the reduced energy consumption.

Both HVAC units are ready for application in regional single and double deck trains (TRL 7). First units for Trams are already ready for commercial operations. But the application is limited to central and north Europe (climate zone 2 and 3) as the performance is reduced above ambient temperatures of approx. 40°C. Although the demonstrators are developed for regional application, the technology can be applied for long distance trains, too.

Furthermore, in the project pre-standardisation work related to HVAC classes and interfaces was carried out to prevent the adoption of HVAC units for every vehicle class, increase the number of similar units, reduce the costs, and allow a simpler refurbishment. Suggestions for pre-standardisation of electrical and control interfaces are given, ready for implementation in European standards.

The results of the project were presented at the final conference of the project PINTA3 in December 2022 and are documented in the public deliverable “HVAC Units with Natural Refrigerants”. The results of the HVAC field tests were also documented.

TD1.8 HVAC									
2015	2016	2017	2018	2019	2020	2021	2022	2023	...
							Ongoing: PIVOT2, PINTA3		

In 2022, out of the 3 deliverables expected, 2 have been delivered. TD1.8 reported having accomplished 70% of the planned work up to the year end, which represents approximately 89% of the overall TD.

1.2.2. IP2 Advanced Traffic Management and Control System

The picture below gives a visual perception on where the TDs will introduce improvements.

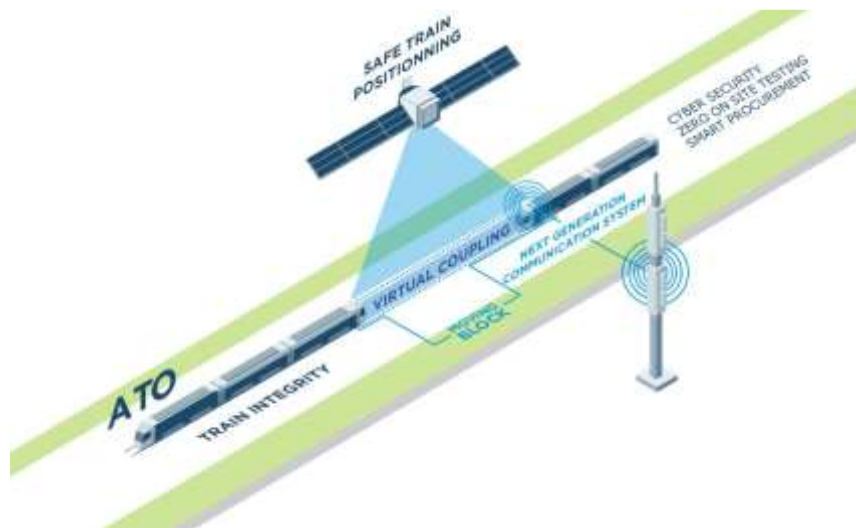

The aim of IP2 is to design and develop a control, command and communication systems that goes beyond being only a contributor to the control and safe separation of trains, and to become a flexible, real-time, intelligent traffic management and automation system.

IP2 builds on ERTMS, that, although deployed in Europe to a limited extent, including on core rail corridors, is a worldwide dominant solution for railway signalling and control systems. Current ERTMS systems do not sufficiently take advantage of new technologies and practices, including use of satellite positioning technologies, high-speed, high-capacity data and voice communications systems (Wi-Fi, 4G/LTE), automation, as well as innovative real-time data collection, processing and communication systems. These have the potential to considerably enhance traffic management (including predictive and adaptive operational control of train movements), thereby delivering improved capacity, decrease traction energy consumption and carbon emissions, reduce operational costs, enhance safety and security, and provide better customer information – all in all, the potential for achieving major cost efficiency results for railway operations.

The picture below shows the TDs connections and dependencies within IP2 and with other IPs and CCA.

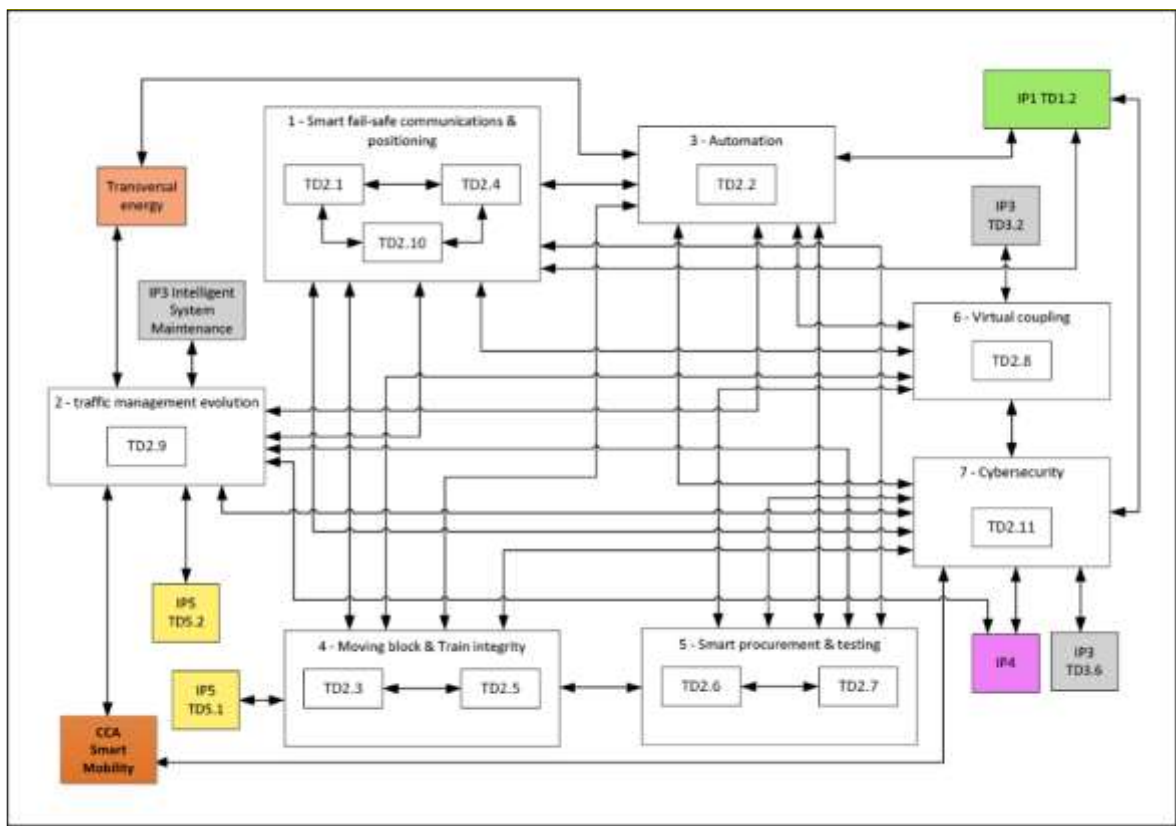

TD2.1 Adaptable communications for all railways

The purpose of this TD is to design, develop and deliver an adaptable train-to-ground communications system using packet switching/IP technologies (GPRS, EDGE, LTE, Satellite, Wi-Fi, etc.) for supporting digital train control applications in all railway market segments. The system will facilitate migration from existing systems such as GSM-R, providing enhanced throughput, safety and security functionalities to support the current and future needs of signalling systems and well beyond; it will be resilient to interference and open to further developments in radio technology.

TD Progress

This TD is developed within the following projects: X2RAIL-5, and AB4RAIL. The projects MISTRAL was completed in October 2018, EMULRADIO4RAIL in November 2020, X2RAIL-1 in June 2021, X2RAIL-3 in November 2021 and AB4RAIL end of 2022.

The main achievements in 2022 are the following:

- Preparation of field tests on the selected tracks;
- Execution of field tests for the Mainline/Highspeed Demonstrator with SNCF in France and with DB in Germany;
- Execution of field tests for the Urban/Suburban Demonstrator with Network Rail in UK;
- Execution of the ACS part in ITD with Network Rail in UK;
- Update of system specification of the ACS;
- Finalisation with studies on alternative bearers and transport protocols.

Based on the development activities carried out in previous projects, two out of three demonstrators with integrated prototypes, have executed their field tests in 2022 as planned.

Two ACS demonstrators have been validated in the field, covering the Railways Segments High-speed/Mainline and Urban/Suburban.

A harmonized test plan was defined on which base the field tests were performed. As part of the test plan, the different test tracks of the involved infrastructure managers were described including the planned test set-up on train and trackside.

Interconnections between different partners' laboratories using simulators and emulators were used for preparing the field tests. Due to the COVID pandemic, remote access to the different laboratories was important to be able to continuously validate integration of prototypes and proceed with the field test preparation in 2022.

The delivered field test plan includes validation of all main technical concepts described in the System Specification of the ACS. Communication at application level is independent from the underlying radio technology. Different options for an application interface for the ACS are evaluated. In cooperation with the Cybersecurity TD, IT security requirements defined in a protection profile were evaluated for each demonstrator.

Field test results from the Mainline demonstrator and the Urban demonstrator already proved the ACS concept successfully in 2022.

Collaboration with the project AB4RAIL generated a lot of additional input for the planned update of the System Specification of the Adaptable Communication System which is due in 2023.

In spite of the target date, interim versions of the System Specifications are built and discussed to take also into account the now available first draft of the FRMCS Functional Specification as well as the FRMCS System Requirement Specification.

Further updates of the Business Model for the adaptable communication were discussed to take into account new business scenarios based on the results from AB4RAIL. As an example interesting analyses were done for the alternative bearer such as FSO (Free Space Optics), LEO (Low Earth Orbit) and HAPS (High Altitude Platform). In particular, NaaS solutions based on LEOs could be a viable backup solution for specific (suitable) tracks.

Apart from the field tests foreseen in TD2.1, the TD also supported the field tests of the integrated demonstrator in X2RAIL-5. Please refer to the specific ITD section of this report.

Finally, the Technology Demonstrator continued its cooperation with the UIC project "FRMCS" (Future Railway Mobile Communication System) which led to further updates of the System Specification of the ACS. This cooperation will continue in 2023 in order to ensure full alignment within the sector, ahead of the preparation of integration of the results in the Control Command and Signalling Technical Specifications for Interoperability (CCS TSI). The System Specification from TD2.1 was discussed in detail with the FRMCS project and have influenced the Functional Requirements Specification as well as the System Requirement Specification for FRMCS.

TD2.1: Adaptable communications for all railways (quality of service, interfaces to signalling)										
2015	2016	2017	2018	2019	2020	2021	2022	2023	...	
		Finished: MISTRAL, X2RAIL-1, X2RAIL-3, EMULRADIO4RAIL, AB4RAIL								
						Ongoing: X2RAIL-5				

In 2022, all planned activities were performed and the three deliverables expected for the period have been delivered. The overall progress is in line with the plan. TD2.1 has reported having accomplished 100% of the planned work in 2022, which represents 83% of progress of the overall TD.

TD2.2 Railway network capacity increase (ATO up to GoA4 – UTO)

ERTMS/ETCS, the current generation of mainline signalling, faces a growing challenge to provide the performance improvements and increases in line capacity needed by (European) Main Line operators.

Using Automated Train Operations (ATO) with ETCS is an answer to this challenge. This technology is already vastly deployed in urban transport where different grades of automation are implemented including driverless and unattended operations. The objective of this technology demonstrator is to develop and validate a standard ATO up to GoA3/4 over ETCS, where applicable, for all railway market segments (mainline/high speed, urban/suburban, regional and freight lines).

TD Progress

This Technology Demonstrator currently builds on the following projects: X2RAIL-4 (launched at the end of 2019) and X2RAIL-1 and ASTRAIL, completed respectively in 2021 and 2019.

ATO GOA 2 activities

Regarding ATO over ETCS on GoA2, the requests for change raised by TD2.2 (further to interoperability tests performed on the Reference Test Bench in January 2019) have been addressed together with the European Union Agency for Railways (ERA) in the context of the ERA Extended Core Team meetings (EECT), responsible for the maintenance and update of the ERTMS/ETCS specifications (in the context of the preparation of the new CCS TSI).

The reports of the two pilot tests executed in 2020 in the United Kingdom and Switzerland have been delivered in March and June 2021, respectively. These reports were also used as the basis for the update of the GoA2 specifications at EECT level.

The following GoA2 specification documents have been delivered discussed and agreed in EECT meetings with the ERA, for integration in the new CCS TSI:

- ATO over ETCS System Requirement Specification (SUBSET-125);
- ATO over ETCS ATO-OB/ATO-TS FFFIS Application Layer (SUBSET-126);
- ATO over ETCS ATO-OB/ETCS-OB FFFIS Application Layer (SUBSET-130);
- ATO over ETCS ATO-OB/TCMS FFFIS Application Layer (SUBSET-139);
- ATO over ETCS Interface Specification - Communication Layers for On-board Communication (SUBSET-143).

ATO GoA3/4 activities

The TD has continued working on the System Requirements Specification for Automatic Train Operations up to Grade of Automation 4 (unattended train operations), further elaborating on the following chapters:

- The operation contexts and the associated actors;
- The operation Use Cases;
- Logical Architecture;
- Interface definition;
- The functional requirements allocated to the Logical Architecture;
- Interface specifications (FIS level) between the Logical Components.

These ATO (up to GoA4) Specification have been frozen in September 2022 to allow the start of the development of the prototypes which will be used for the pilot tests in factory and on site in 2023.

Specification of the Reference Test Benches are currently under development to be used for the factory tests. The pilot test scenarios are under development. The pilot train fitment required for supporting ATO GoA4 is also under definition.

In parallel with these activities dedicated to the pilot tests, the TD2.2 continues to refine the specification of ATO (up to GoA4).

To perform this refinement, the TD is working jointly with the following projects:

- OCORA: the aim is that the logical architecture issued by TD2.2 and the OCORA initiative are aligned;

- CONNECTA series: the aim is, first, to agree on the standard interfaces between the ATO (up to GoA4) system and the TCMS; and, secondly, to agree on the functions exported to the TCMS;
- SFERA: the aim is to agree on a common specification for the track/train communication for Driver Advisory System (DAS) and ATO application.

The work performed in 2022 and to be tested and validated in 2023 via on site testing will constitute a major input for the work to be taken a step further in the Europe's Rail Programme.

In 2022, no deliverable was expected. The project reports having accomplished 100% of the work for 2022 which corresponds to 80% of the overall TD activities.

TD2.2: Railway network capacity increase (ATO up to GoA4 – UTO)									
2015	2016	2017	2018	2019	2020	2021	2022	2023	...
			Finished: X2RAIL-1, ASTRail,						
						Ongoing: X2RAIL-4			

TD2.3 Moving Block

Improving line capacity by decoupling the signalling from the physical infrastructure, and removing the constraints imposed by trackside train detection is the key objective of this technology demonstrator. This will allow the transit of more trains on a given (main) line, especially for high-density passenger services. The system is expected to be compatible with existing ERTMS specifications and will enable progression towards CBTC (Communication Based Train Control) functionalities for urban applications.

TD Progress

This TD is currently building on the following projects: X2RAIL-5 and PERFORMINGRAIL, both launched at the end of 2020. X2RAIL-1, X2RAIL-3, ASTRAIL and MOVINGRAIL were also contributing to the work of the Technology Demonstrator.

In 2022, the TD updated the System Requirements, Operational and Engineering Rules and Safety Analysis, and created a report on the three Moving Block Technical Demonstrators within X2Rail-5:

- The updated System Requirements Operational and Engineering Rules reflect validation of the work from X2Rail-3 via the examination of a number of "Use Cases", and examination of number of specific topics, including Train Location, and Track Status. There are now much more clearly described in the updated documents.
- The Safety Analysis includes the Risk Analysis and has been updated to be compatible with the new version of the System Requirements, Operational and Engineering Rules.
- The report on the three Moving Block Technical Demonstrators highlights the achievements of these Demonstrators, and validates the approach taken within the System Requirements.

The TD has created two main MB concepts:

- Full Moving Block (FMB): The system can issue Movement Authorities based on the reported location of the rear of the preceding train. End of Authority can therefore be at an arbitrary location in the railway.
- Fixed Virtual Block (FVB): The system determines occupancy of the Fixed Virtual Blocks based on reported train locations. In this system the end of a Movement Authority can only be at discrete locations predefined during system design.

Three Moving Block demonstrators were created. Two of the demonstrators were implemented for the Fixed Virtual Block System Type. The other demonstrator was implemented for the Full Moving Block System Type. In each case, the demonstrators showed a number of different scenarios, which are listed in the report. For example:

- Normal Train Movement
- End of Mission, Start of Mission
- Loss of Communications

- Loss of Train Integrity

The demonstrators addressed respectively the following market segments: high speed, flow traffic and urban/suburban traffic. Full moving block was tested and proven on the high speed demonstration. The concept has been proven also flagging aspects to be fine-tuned in the specifications.

The work in X2Rail-5 represents the final round of improvement to the Moving Block specification. Within 2022, the TD has been focusing on answering some of the open points remaining at the end of the work in X2Rail-3 and re-assessing the specification against the Use Cases. One new Use Case Description has been prepared, Use Case Reserved, which covers the processes for requesting and extending a Reserved area of track for a train. The specification was released at the end of 2022. This deliverable specifies the behaviour of the ETCS Trackside in Level 3 Moving Block, together with Operational and Engineering Rules and safety analysis.

On the side of the ongoing complementary project, PerformingRail, work in 2022 has focused on the following:

- Development of a functional architecture for the MBS using the combined formal methods Timed Automata and Stochastic Activity Networks.
- Provision of an affordable multi-constellation multi-frequency GNSS computer and perform data campaign in real scenarios for MBS applications.
- Development of an optimal traffic rescheduling model for MB which embeds constraints from identified, and a traffic prediction model to detect conflicts and hazards under MB operations.
- Development of a railway simulation environment integrating UoB's railway operation simulator and ROKUBUN's GNSS simulator to test and assess the developed PERFORMINGRAIL Proof of Concept.

The TD will deliver in 2023 the final document closing its activities in the S2R programme. This deliverable will encompass recommendations for Moving Block related "enhancements" i.e. impacts on introducing the Moving Block concept in the ETCS specifications.

TD2.3 Moving Block									
2015	2016	2017	2018	2019	2020	2021	2022	2023	...
		Finished: X2Rail-1, ASTRail, X2Rail-3, MOVINGRAIL					Ongoing: X2RAIL-5, PERFORMINGRAIL		

In 2022, the TD has delivered all the expected five deliverables for the period. TD2.3 has reported having accomplished 100% of the planned work up to the year end, which represents 98% of the overall TD. The overall progress appears to be in line with the plan.

TD2.4 Fail-Safe Train Positioning (including satellite technology)

This Technology Demonstrator aims at developing an innovative Fail-Safe Train Positioning (FSTP) system, using Global Navigation Satellite Systems (GNSS) as the preferred technology to compute absolute positioning.

Currently, two possible approaches towards introduction of satellite-based positioning technology for railways are being analysed. On one side, the FSTP is as a functional block of the current core of ERTMS/ETCS and absolute positioning is based on the Virtual Balise (VB) concept, reducing the impact on current specifications. On the other side, the FSTP is a stand-alone subsystem that calculates the train travelled distance, speed and absolute train position via an enhanced, safe, multi-sensor apparatus.

Both approaches aim at enabling the use of new technologies to boost the quality of train localisation and integrity information, while also reducing the overall life cycle costs, in particular by enabling a significant reduction in all conventional trackside (train) detection systems, such as balises, track circuits or axle counters.

TD Progress

During 2022, this TD was implemented by the following projects: X2Rail-5 and PerformingRail, both projects launched at the end of 2020.

X2Rail-5 aims at completing the remaining activities foreseen in TD2.4 by bringing the work to higher TRL levels, for the defined demonstrators.

A dedicated activity aims at defining an interoperable solution for the Satellite-Based Fail-Safe Train Positioning system, through the continuation of the work done in previous projects. Interaction with other projects and collaboration with relevant organizations (ERA, EUSPA, ESA, etc.) is also managed within this task.

During 2022, the following objectives have been addressed:

- In collaboration with the Joint Working Group set with the ERTMS Users Group (EUG) and the Space Agencies (EUSPA, ESA, ESSP), the Augmentation for rail topic has been thoroughly analysed. The relevant documents released from the Agencies (including SRS, ICD, SFHA and GNSS Receiver Guidelines) have been discussed and reviewed with the Agencies and EUG. Key technical concepts addressed included: Tropospheric Model, Data Processing & GNSS Acquisition (including supporting two or more SBAS streams), GNSS Receiver Design & Constraints (smoothing filter, correlator), THR Apportionment (including pseudorange integrity risk concept), Time Synchronisation, Trackside Functional Architecture and Version Management. The activities led to an updated version of the documents ready to be handed over to the System Pillar, and to the identification of the main topics that will be the subject of work from the Agencies and the future technical teams on the subject of Augmentation.
- Starting from the Gap Analysis developed in 2021, the first phase of the activities for the definition of a Roadmap and Migration Strategy have been launched, with the aim to prepare an overall concept for the introduction of the localization function in the Control-Command and Signalling (CCS) Technical Specification for Interoperability (TSI). The functions of the two possible approaches towards introduction of satellite-based positioning technology for railways have been thoroughly analysed and consolidated, and the study of the integration and impact of the solutions in the current CCS and ETCS has been carried out. That led to the identification of several commonalities between the two approaches, which will be investigated in 2023 in order to define the future FSTP and the related migration strategy and roadmap.

Two additional streams of the work are dedicated to the finalization of the activities carried out in previous projects concerning the development of both Virtual Balise based and Stand-Alone Fail-Safe Train Positioning System demonstrators.

Regarding Virtual Balise based Fail-Safe Train Positioning System, both laboratory setup and preparation of Trial Sites have been completed.

Regarding Stand-Alone Fail-Safe Train Positioning System, initial recordings are being analysed. A set of use cases have been defined as “interesting targets” and scripts to harmonise the analyses have been developed. Demonstrators are set and ready for the final testing phase, which is going to be executed during 2023.

PerformingRail, the complementary open call project, aims to delineate through formal modelling and optimised traffic management, a moving block railway signalling using advanced train positioning approaches that mitigates potential hazards for the different type of traffic.

In 2022, GNSS Location simulator (GLS) have been developed to simulate complete GNSS receiver and include issues derived from feared events (limited visibility, multipath, spoofing, interference and signal degradation). A campaign has been organised in October 2022 to gather data. Finalization of simulations, testing and data processing is foreseen in 2023.

In 2022, the TD has delivered all expected deliverables. TD2.4 has reported having accomplished 100% of the planned work up to the year end, which represents 68% of the overall TD. This low percentage is

explained by the fact that a number of field tests will take place in 2023. A lot of efforts are still expected to be provided in the last year of the programme in order to finalise this technology demonstrator.

TD2.4: Fail-Safe Train Positioning (including satellite technology)									
2015	2016	2017	2018	2019	2020	2021	2022	2023	...
Finished: X2Rail-2; ASTRail, GATE4Rail					Ongoing: X2RAIL-5, PERFORMINGRAIL				

TD2.5 On-board Train integrity

This Technology Demonstrator aims at specifying and prototyping an innovative on-board train integrity solution, capable of autonomous train-tail localisation, wireless communication between the tail and the front cab, safe detection (SIL4) of train interruption and autonomous power supply functionality without the deployment of any fixed trackside equipment. This functionality will be developed for those market segments (e.g. freight and low traffic lines) lacking such functions.

TD Progress

This TD is currently built on the progress of X2Rail-4 and past results of X2Rail-2 and ETALON projects.

The key achievements of this TD are the following, based on the specification work and demonstration activities held during the programme.

- **Demonstrator for OTI Product Class 1:** applicable to trains equipped with Ethernet on-board communication network. Train integrity monitoring is based on head-tail communication liveliness. Train length is determined with network topology discovery techniques and configuration parameters stored within OTI devices (i.e. wagon length). This solution implies installing OTI devices in each wagon.
- **Demonstrator for OTI Product Class 2:** applicable to trains not equipped with any wired on-board communication network and with ETCS in each train end. Train integrity is based on comparing head-tail speed acquired from ETCS and exchanged over radio through ACS gateway with two public cellular operators. OTI head-tail pairing procedure is based on communication with TMS to acquire the identifier of the OTI device located at each train end. Train Length is determined by acquiring same balise with head and tail. This solution implies presence of ETCS and ACS gateway in each locomotive and communication with TMS.
- **Demonstrator for OTI Product Class 3:** applicable to freight trains without any wired on-board communication network. Train integrity is based on detecting separation between adjacent waggons by using RSSI, IMU and GPS sensors. Train length is based on network topology discovery techniques and comparison with TMS train composition data. This solution implies installing OTI devices in each wagon and communication with TMS.
- **Benefits** provided by investigated solutions consist in providing on-board train integrity and train length determination functionalities for different type of passenger and freight trains thus enabling virtual and moving blocks for capacity increase and ensuring cost reduction for trackside train detection system.

The TD has demonstrated having achieved the development and testing of three different solutions for providing on-board train integrity. Together with the testing of the solution on different lines, the TD has also performed an extensive preliminary safety analysis which can support at a latest stage, safety cases when developing products and before placing them on the market. Finally, a migration analysis has also been performed.

TD2.5: On-board Train Integrity									
2015	2016	2017	2018	2019	2020	2021	2022	2023	...
Finished: X2Rail-2; ETALON					Ongoing: X2RAIL-4				

In 2022, the TD has delivered the 3 expected deliverables. TD 2.5 is reporting having accomplished 100% of the planned work up to the end of 2022, which represents 100% of the overall TD. The TD has completed its activities at the end of 2022.

TD2.6 Zero on-site testing (control command in lab demonstrators)

The development of a new laboratory test framework comprises simulation tools and testing procedures for carrying out open test architecture with clear operational rules and simple certification of test results. It aims at minimising on-site testing (with the objective of Zero On-Site Testing – ZOST) by setting-up full laboratory test processes, even when systems comprise subcomponents of different suppliers. The test framework will also allow remote connection of different components/subsystems located in various testing labs.

TD Progress

The activities related to this TD were started in X2RAIL-1 and the first results have been ready since December 2018. These results include a benchmarking analysis, the description of the test process and the definition of a full system test architecture for the necessary test environment to support shifting testing from the field to the lab. In this timeframe the results of the VITE open call have been jointly analysed and taken into account.

The TD over the course of the previous years and activities has defined the following:

- A generic communication model;
- data modelling for the test environment;
- validation of data with formal methods.

In 2022, the activities of the TD focused on the final definition and implementation of different prototypes (based on the architecture. Focus has been put on the ETCS game changers Moving Block and ATO. The objective is to provide additional simulation capabilities to the test environment developed in the TD. The focus will be brought on the interoperability testing between suppliers (testing handover scenarios across borders between two RBCs provided by two different suppliers: The prototypes are focusing on the following:

- Moving Block – will provide adapters to test the Moving Block System;
- ATO – 2 different types of demonstrators focusing on the implementation of the adapters and the tuning of operational speed profiles within different segments;
- ACS – focusing on the transitioning from GSM-R to ACS;
- Train Integrity – adding train integrity adapters;
- TMS/PIS – demonstrator for auto testing of PIS/TMS using CDM;
- SWOC – prototype for online observation to mitigate outage.

The implementation of the prototypes has started in 2022 and will be finalized in 2023.

TD2.6: Zero on-site testing (control command in lab demonstrators)										
2015	2016	2017	2018	2019	2020	2021	2022	2023	...	
			Finished: X2RAIL-12, X2RAIL-3, VITE, GATE4RAIL							
							Ongoing: X2RAIL-5			

In 2023, the TD will deliver the finale reports on the implemented prototypes/demonstrators. TD2.6 has reported having accomplished 100% of the planned work up to the end of 2022, which represents 82% of the overall TD.

TD2.7 Formal methods and standardisation for smart signalling systems

Formal methods (FMs) provide the means to establish correctness of a system model with respect to given properties, to improve verification, certification, and authorisation processes, while reducing the need for

extensive field tests in the future. To verify safety is considered one of the most compelling use cases for FMs. FMs and standard interfaces aim to contribute to reduced life cycle cost and time-to-market, increased market competition and standardisation, and improved interoperability and reliability. While standard interfaces are orthogonal to formal methods (one can use one without the other), they help increase competition, and enable more efficient use (and reuse) of formal methods.

TD Progress

This TD builds on the following projects: X2RAIL-5, PerformingRail as well as on X2RAIL-2 and 4SECURail (completed in 2021). The open call PerformingRail applies formal modelling and optimal traffic management to moving block with advanced train positioning, to mitigate potential hazards.

In 2022, TD2.7 focused on applying FMs at the system of systems (SoS) level for deeper analysis of moving block requirements defined by TD2.3 (validate consistency, find mistakes, propose improvements, etc.). This work focused on gaining sufficient understanding of the concepts defined by TD2.3 to create the demonstrator for Level 3 Trackside, foreseen to take place in 2023. A deliverable stemming from this work was issued, describing configuration data for ERTMS L3 trackside with requirements for formal verification.

The second area of focus in 2022 was to define methodology and toolchain to automate transformation and formal verification of EULYNX specification models, to meet the needs of future Functional Railway System Architectures. There are several approaches for applying formal methods to SysML models. This work focused on describing approaches and toolchains to automate the transformation of a EULYNX SysML model to a formal model by reducing the manual work significantly. The input is a EULYNX SysML model and the output is a formal model which is subjected to formal verification of requirements.

The third area of focus in 2022 was to define the first intermediate version of the Formal Methods Guidebook deliverable, towards the final version to be issued at the end of X2Rail-5 in 2023.

TD2.7: Formal methods and standardisation for smart signalling systems									
2015	2016	2017	2018	2019	2020	2021	2022	2023	-
			Finished: X2Rail-2, ASTRail, 4SECURAIL						
						Ongoing: X2RAIL-5			

In 2022, no deliverable was expected. TD2.7 has accomplished 100% of planned work up to the year end, which represents 85% of the total calendar time planned for TD2.7 in X2R-5.

TD2.8 Virtually – Coupled Train Sets (VCTS)

The TD was completed in 2021.

TD2.9 Traffic Management Evolution

The goals of a future Traffic Management System are to improve traffic management operations with new advanced applications, integrating real time data from different business services into automated decision-making processes.

TD Progress

This TD currently builds on the work performed in X2RAIL-2 (concluded in 2021), X2RAIL-4, FINE2 (Cross Cutting Activities) and OPTIMA.

The communication network (Integration Layer), Application Programming Interfaces (FINE2), interoperable Data Model have been specified, implemented, validated to successfully manage the receipt and the publication of data used for Traffic Management and Traffic Control operations. The availability of real time data of different services enables the new developed business applications to significantly improve the quality of their decisions to manage the rail traffic.

Seven demonstrators addressing Connected Driver Advisory System (C-DAS), Wayside ATO (WATO), general TMS Business Applications such as Dispatching, Conflict Detection & Resolution, Possession Management, presentation of Field Data (Signalling) and Data Integration of different business services

e.g. Weather Information and User Interfaces were successfully developed up to TRL 6 tested and documented.

An additional large-scale scenario test campaign was designed and executed to validate the concept and the applicability of the Integration Layer, the Application Programming Interfaces and the interoperable Data Model.

The key results are the following:

- For one country, the publicly available data of the topology and timetable were transferred to interoperable data structure and are available in the Integration Layer of the TMS Cloud which could be extended in succeeding projects to become a solution for a “Cross-Border” or “European TMS” prototype.
- The specification and implementation of the communication network, Interfaces and Data Model comply with all operational needs for the applied use-cases Timetable Management and wayside ATO operation.

In a second step, the implementation of the Integration Layer developed inside the complementary open call project OPTIMA was linked with the so called TMS Cloud publishing status data of different field objects to the central data communication network.

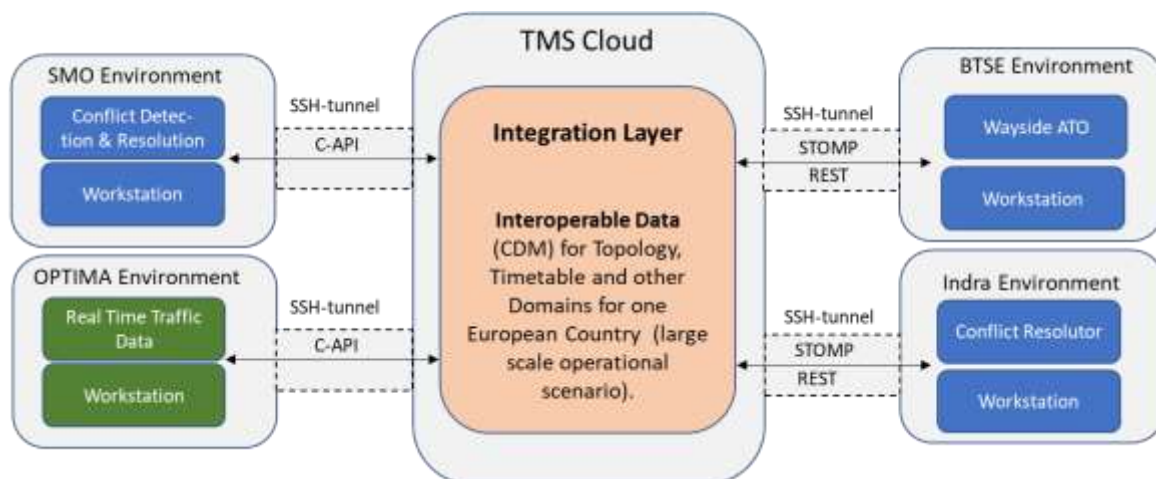

Architecture of the large-scale Demonstrator

TD2.9 has continued to develop the specification and design concepts of new Traffic Management functionalities based on use cases developed in X2RAIL-2 with focusing on standardised and automated conflict handling using the most promising solution and learning algorithms for large-scale network optimisation.

The concept includes how to present, interact with, and negotiate the large-scale conflict resolutions required for a highly automated TMS. In addition, the TD has evaluated methods for improved measurement of workload and situational awareness of control centre operators.

In 2022, OPTIMA has successfully finalized the development and testing of its platform and participated in the large-scale scenario campaign to validate the results.

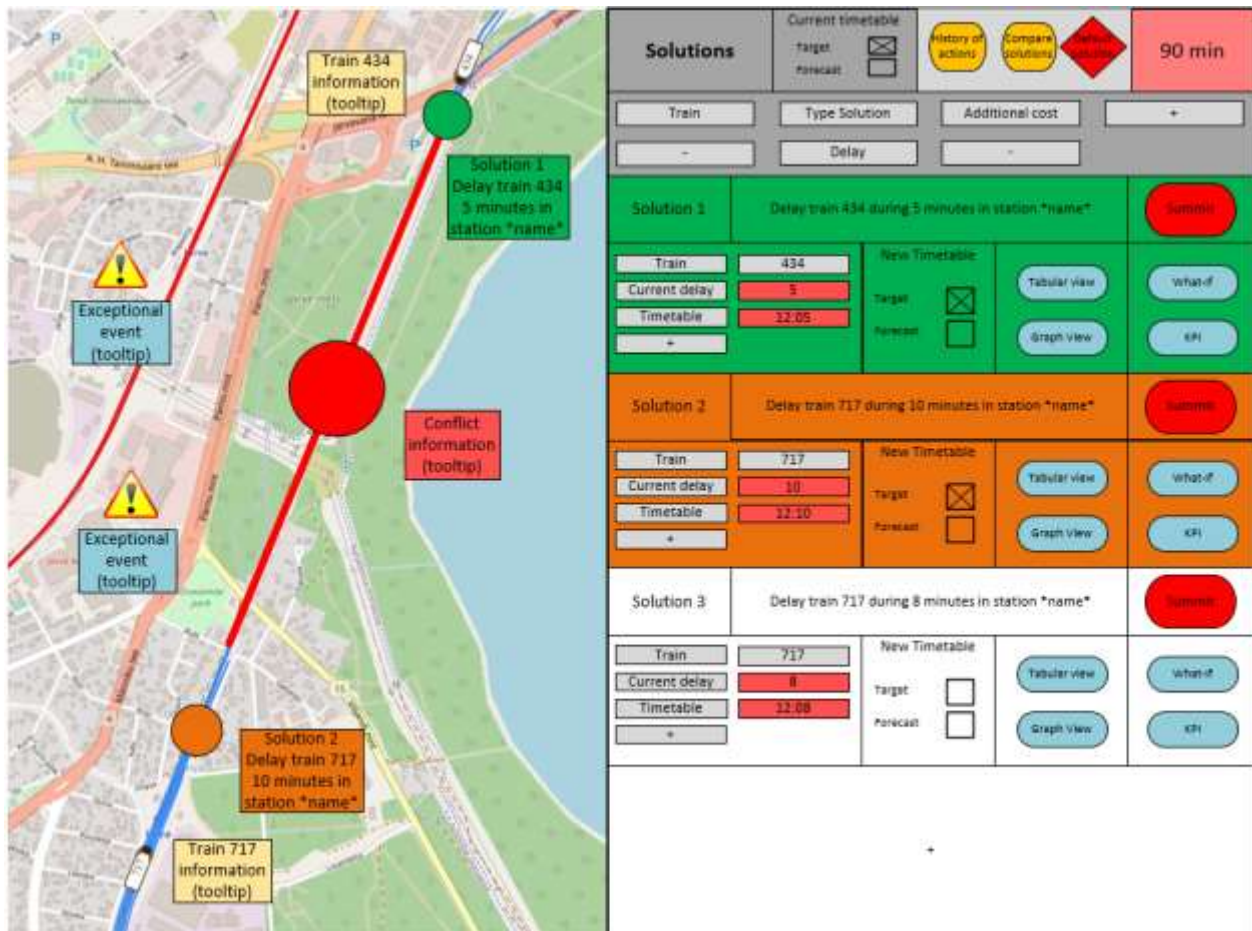

Example of geographical representation of solutions.

In 2022, the TD has delivered 4 of the 6 expected deliverables. TD2.9 is reporting having accomplished 67% of the planned work up to year end, which represents 90% of the overall TD.

TD2.10 Smart radio-connected all-in-all wayside objects

The objectives of this technology demonstrator are to develop an autonomous, intelligent, maintenance free smart equipment ("box") able to connect with any signalling wayside object and communicating device in the area (wireless), guaranteeing safety and security, by the definition of a common architecture and of requirements and interface specifications. The TD will develop concepts for locally derived power, for the overall reduction of power consumptions and required cabling as well as to specify interfaces with control, power, diagnostics and maintenance systems using both low and high-capacity wireless links.

These "intelligent" objects – knowing and communicating their status conditions – would not only provide opportunities in terms of cost reduction and asset management improvement, but also establish new means for management and control of railway network information.

TD Progress

This TD currently builds on the following projects: X2RAIL-1, ETALON (both completed in 2019), and X2RAIL-4.

In 2022, the TD focused on the Implementation and Validation of selected demonstrators at TRL6. The aim is to further enhance the demonstrators in operationally representative environment to reach Technology Readiness Level 6. Some demonstrators will be ongoing until 2023.

The methodology used to generate the correspondent deliverables is described here below:

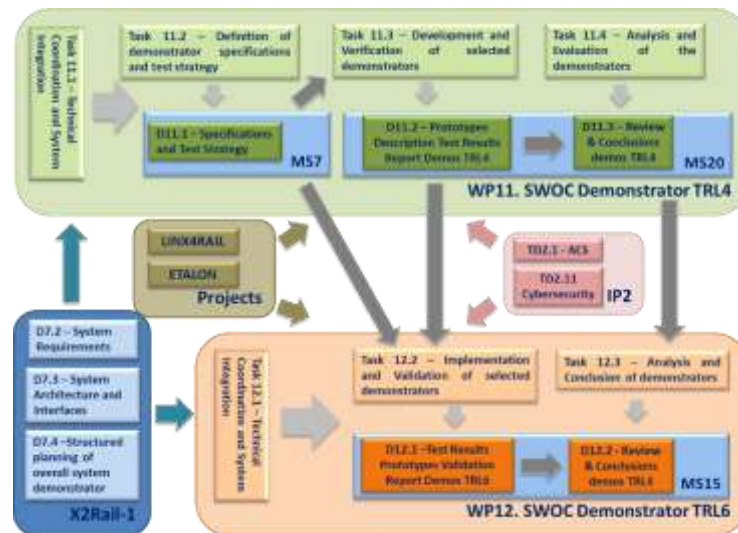

The main focus of the demonstrators was to develop and test the requirements in an operationally representative environment against the use cases described in the following table:

Use Case	Existing OCs	SWOC	Demonstrator
IXL control management	✓	(A)	(A)
OBU Interface with SWOC	✗	(O)	(P)
TMS interface with SWOC	✗	(O)	(P)
SWOC distributed Architecture	✗	✓	✓
Safety Conditions	✓	✓	✓
Power Management	✓	(A)	(A)
Management of SWOC deployment	✗	✓	✓
Communication Management	✓	(A)	(A)
Security	✓	(A)	(A)
Maintenance Management	✓	(A)	(A)
Diagnosis Management	✓	(A)	(A)
Asset Management	✓	(A)	(A)

✓ OK: Available ✗ NOK: Not available ✓ (A) OK (Advanced): available and improved ✓ (O) OK (Optional): available only if desired ✓ (P) OK (Partially): Partially available

Also, different operational scenarios, in terms of market segments, types of wayside element controlled, communication type, control entities, diagnosis & maintenance features and power management have been defined. At least one sub-demonstrator shall cover the use case of each type of wayside element.

For this purpose, eight different demonstrators have been defined in order to cover a large spectrum of suitable scenarios, with the intention of being able to test, in greater detail and precision, each of the functionality/features to be covered by the SWOC.

The demonstrators and the partners involved are:

1. Wireless Low Power Object Controller demonstrator,
2. Track vacancy detection SWOC demonstrator.
3. Cable Less Railway Embankment Demonstrator
4. Multiple Networks Scalable SWOC,
5. Smart Wayside Object Controller,
6. Gate Signal Smart Wayside Object Controller,
7. Wireless, Advanced Diagnosis, Intelligence distribution and Low Power Consumption
8. New generation of adaptable Wireless sensor Network for way side objects in railway environments.

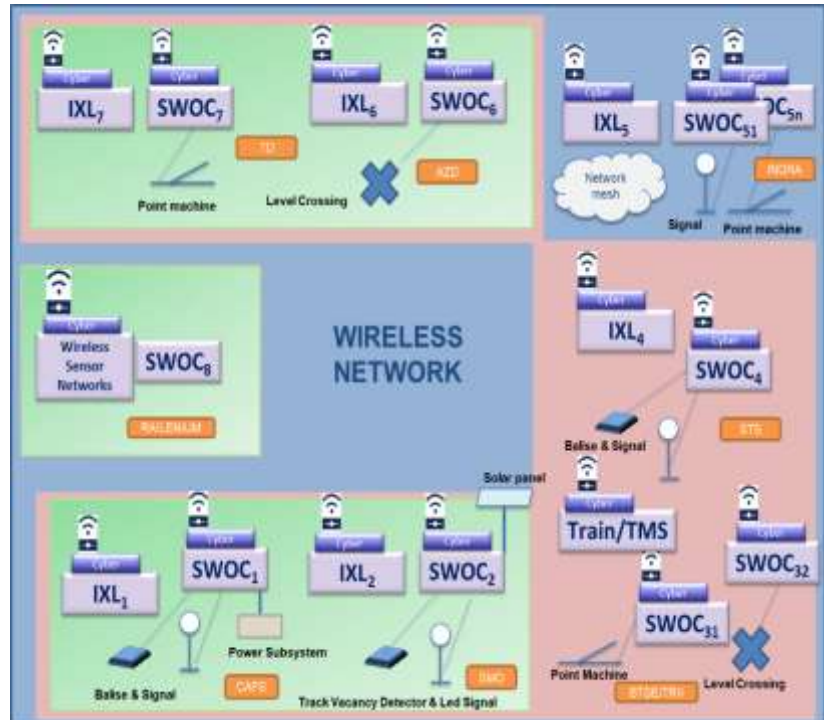

The testing and demonstrators will continue in 2023, with the preparation up to TRL6 progressing as per schedule.

TD2.10: Smart radio-connected all-in-all wayside objects								
2015	2016	2017	2018	2019	2020	2021	2022	2023
		Finished: X2Rail-1, ETALON						
					Ongoing: X2Rail-4			

In 2022, no deliverable was expected. The overall progress was in line with the plan. TD2.10 reports having accomplished 100% of the planned work up to the year end, which represents 90% of the overall TD.

TD2.11 Cybersecurity

The interconnected digital railway network at European level is constantly growing and will keep on growing, which will increase the number of risks associated to security. There is therefore a growing need for handling these cyber-security threats in railway systems. This technology demonstrator aims at achieving the optimal level of protection against any significant threat to the signalling and telecom systems in the most economical way (e.g. protection from cyber-attacks and advanced persistent threats coming from outside).

TD Progress

The activities of the TD are addressed via the projects X2Rail-1, X2RAIL-3, 4SECURAIL (all completed in 2021) and X2Rail-5. The following achievements have been reached in 2022:

- Completion of joint analysis and demonstrator with other TDs/Cybersecurity assessment of other TDs;
- Integrated technical demonstrator with adaptable communication TD: Security Assessment;
- Integrated technical demonstrator;
- Completion of the ISAC prototype and its validation and Operator Statement;
- Analysis of railway systems' cyber resilience.

Completion of joint analysis and demonstrator with other IP1 and IP2 TDs: Cybersecurity assessment of other TDs

Two demonstrators involving other TDs have been started. The first demonstrator consists in performing cybersecurity analyses of the architectures proposed by some other TDs and to provide them some

recommendations for hardening. The concerned TDs (ATO GoA2, ATO GoA3/4, and TCMS), the proposed potential mitigations, architecture changes and countermeasures to fulfil the cybersecurity recommendations were assessed.

In the course of 2022, a risk assessment methodology has been developed, fully aligned with ISA/IEC 62443 series of standards, as well as with CL TS 50701. Furthermore, an excel tool has been developed that implements this methodology.

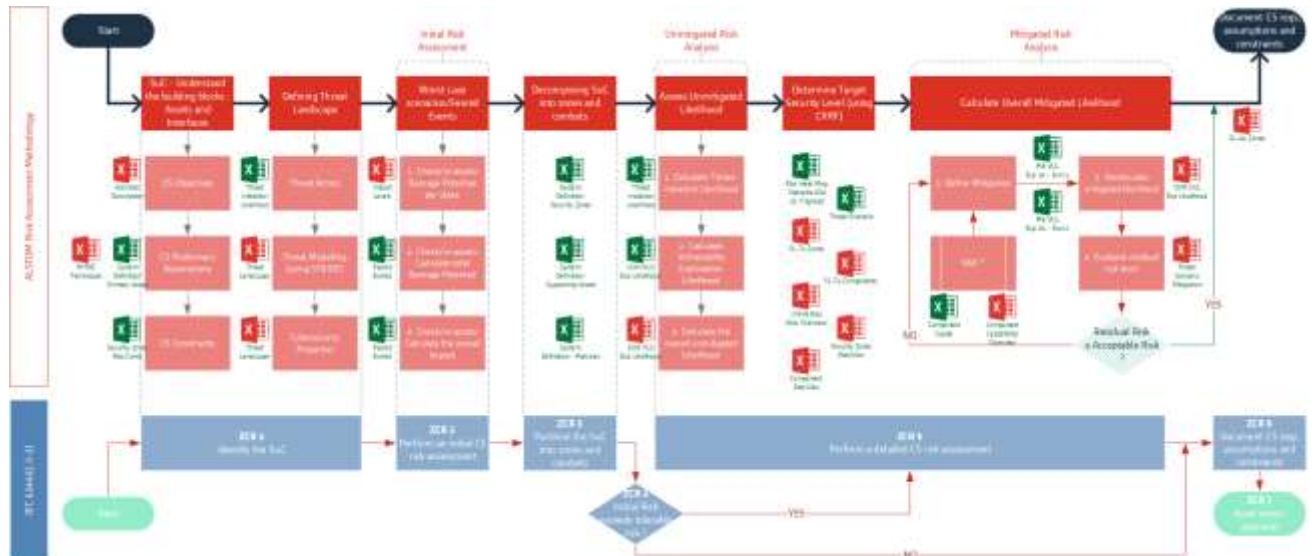

One of the key challenges that have to be addressed was to introduce in the scope of the methodology the management of attack paths (as part of the collaboration with the S2R TCMS activity, via the project CONNECTA-3), as well as to improve the impact and likelihood criteria defined in the previous Simplified Risk Assessment methodology, to match with the NG-TCMS environment. For both TDs (ATO, TCMS), special attention has been given to the management of Safety functions with respect to cybersecurity attacks, which was not covered by the previous analysis. The risk assessment is expected to be finalized and concluded in the first quarter of 2023.

Integrated technical demonstrator with adaptable communication TD: Security Assessment

The goal was to validate and assess the TD2.1 (ACS) Technical Demonstrator based on the proposed Protection Profile. The results of the technology demonstrator lab and field test reports have been analyzed and mapped to the security requirements of the protection profile. The draft version of the field test plan of the ACS TD has been analyzed which allowed to select the applicable requirements and map them to ACS protection profiles defined in the project. The result, which report is pending as of the end of 2022, was then mapped to mitigations and attack techniques of the MITRE Attack Framework for ICS.

Integrated technical demonstrator

This new demonstrator aims to validate and assess the security requirements defined in the TSI CCS 2022 (a subset of the protection profiles defined during the course of the TD).

In 2022, the demonstrator was set up as a cloud service which facilitated the collaboration between the TD members. It includes two onboard and trackside rail automation mock-ups which implement the new TSI CCS / UNISIG subset 146 security requirements, as well as the shared security services for onboard, trackside and back office required for the new TSI. Additionally, security and penetration testing were performed on the demonstrator to validate the security functions as well as the cyber resilience.

A requirement tracing from the full protection profile will be performed in Q1 2023 to identify the missing requirements for future developments inside Europe's Rail (and specifically in the System Pillar).

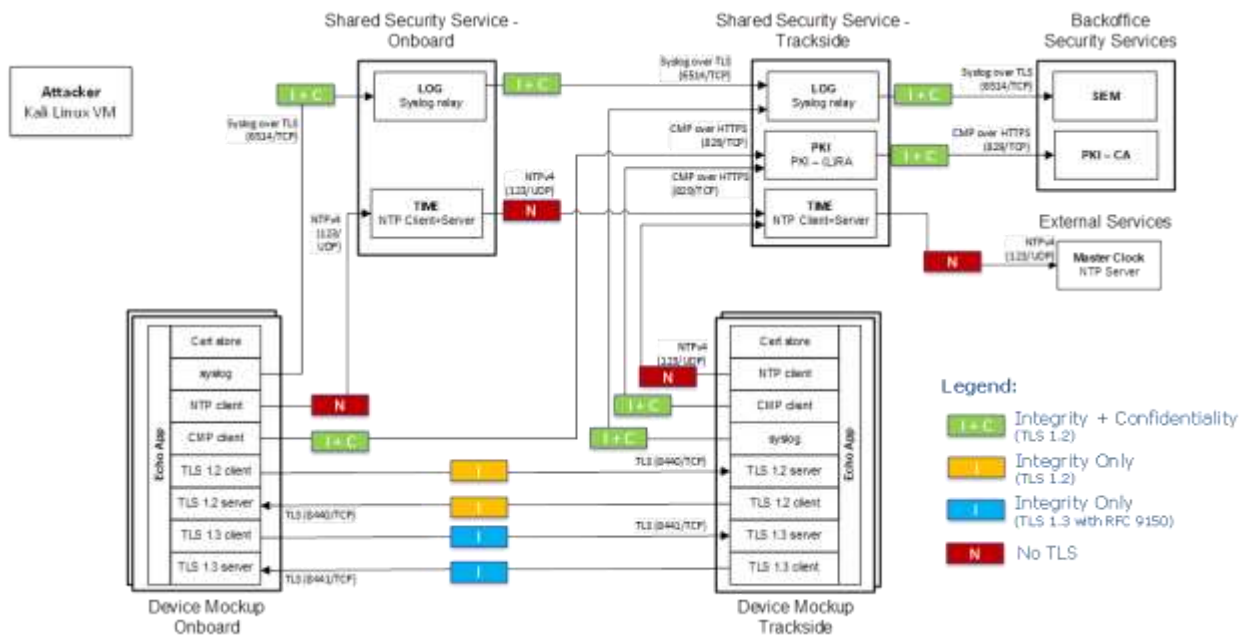

Completion of the ISAC prototype and its validation and Operator Statement

ISAC prototype verification, validation and test Use-case is describing how DB has implemented and tested a railway ISAC. Based on the experience of different ISAC projects, DB has prepared an ISAC platform called prototype. This platform has been tested in 2022.

Summary Statement from the perspective of an operator has been prepared with respect to the analysis of the ISA IEC 62443-2-1 part of the standard as well as the analysis of ISO 27001/2 and how to integrate both standards together. Processes, people, technical and regulatory requirements have been considered to define what must be prepared for the different aspects by Operators and what must be delivered by the supply chain so that Operators can fulfil their responsibilities, utilizing the results of the Holistic Approach developed previously in the TD.

There is an on-going task, which will be completed in the first quarter of 2023, with respect to the level of accepted cybersecurity for a proper operation. Here below can be found a list of the remaining activities to be performed:

- Analysing impact for operation in applying SL 3 or SL 4 of IEC 62443;
- Analysing gaps and challenges for operation (regulatory, supply chain, cost of security);
- Finalizing preparation of summary exchange tables of what must be delivered by the supply chain;
- Summary of the main conclusion.

Analysis of railway systems' cyber resilience / Recommendations on railway systems' cyber resilience

The NIST SP 800-160 Vol.2r1 12/2021, the Mitre Attack Framework, the ENISA Threat Landscape, and the EU Cybers Resilience Act (draft) have been analysed to identify cyber resilience related concepts, and provide clarifications and recommendations upon the different cyber resiliency techniques:

- selected APT attacks to the railway reference system have been analysed to identify cyber resiliency implementation approaches when performing an Initial Risk Assessment according to IEC 62443-3-2: based on ATT&CK Framework ICS tactic Impact techniques, mitigations, and related risk effects;
- essential cybersecurity requirements for Vulnerability management have been identified.

In 2023, the main goal is to complete this analysis by analysing the IEC 62443 requirements for cyber resilience capabilities. To identify complementary recommendations for Cyber resilience of railway system.

TD2.11: Cyber Security									
2015	2016	2017	2018	2019	2020	2021	2022	2023	...
Finished: X2RAIL-1, X2RAIL-3, CYRAIL, 4SECURAIL						Ongoing: X2RAIL-5			

In 2022, no deliverable was expected. The overall progress is in line with the planned activities. By the end of 2022, the TD has accomplished 100% of the planned work, which corresponds to 90% of the overall progress of the TD.

ITD: Integrated Technical Demonstrator (Adaptable communication System, Moving Block and Onboard Train Integrity).

The purpose of this ITD was to take the outputs of three other of the IP2 Technology Demonstrator (Adaptable communication System, Moving Block and Train Integrity Monitoring System, also known as Onboard Train Integrity) and integrate them onto an ETCS capable passenger train (Class 717) and demonstrate these capabilities working in harmony in a railway environment, running on the same track with the NR ETCS Class 313 test train. The testing and demonstration took place at the UK ERTMS National Integration Facility (ENIF) North of London.

ITD Progress

This ITD builds on related activities implemented in the following projects: X2RAIL-1, X2RAIL-3, X2Rail-4 and X2RAIL-5.

The main achievements of 2022 were the following:

- Design of the individual systems and an understanding of the overall system definition for the integrated capabilities;
- Establishing all communication bearers at ENIF and ensuring the secure links were available, tested and working prior to the commencement of the demonstration;
- Preparation of the final configuration and shipment of software and LRUs/Equipment to the UK for fitment to the Class 717;
- Delivery of a harmonized Field Test plan for the demonstration of the capabilities;
- Establishing all the logistics for the demonstration and modifying the Class 717 passenger train with new software and hardware so that all three capabilities were integrated with each other and the ETCS onboard system of the Class 717;
- Integration testing of the ETCS Moving Block software between the onboard and trackside components using labs in Berlin and UK;
- Securing all testing resources and ensuring approval of the test pan by the nominated competent Tester in Charge;
- Successfully completing the testing in accordance with the approved test plan;
- Disseminating and communicating on the ITD via a video.

The Final Report on the ITD is currently being produced and will be made available in 2023. To get to this stage the partners have integrated the Train Integrity Monitoring System (TIMS), Adaptable Communication System (ACS) and Moving Block capabilities onto a Class 717 passenger train, designing a specific modification pack which was approved by the Train Sponsor and Train Operator. During the preparation stage, many design issues were overcome in a dynamic environment showing great collaboration between the partners. The ETCS L3 trackside components were also integrated into the ERTMS National Integration Facility in Hitchin overcoming communication issues by working with specialist Network Rail teams. The Network Rail Class 313 test train was used as the second ETCS train during testing, reacting to the various outputs from the Class 717 via the trackside as the test plan was enacted.

The Adaptable Communications System (ACS) was integrated into the Class 717 to allow the ETCS data to be transmitted via the ACS to the trackside and vice versa. The Moving Block software on the Class 717 was updated to allow the system to react to Train Integrity inputs (CR940) which were fed into the ETCS onboard (train length and completeness). The Moving Block Team developed the trackside elements of the ETCS system and interlocking providing the capability to use Fixed Virtual Blocks on the ENIF test track. The ITD was able to show the track layout on a screen in the lab and capture the movement of both the Class 717 and 313 trains, showing occupied track and the movement authority for both trains. The Train

Integrity Management System was mounted on the class 717 and connected into the ETCS onboard system. The demonstrator was able to show the successful integration of all 3 capabilities onto an in-service class 717 passenger train.

The ITD showed that all the elements demonstrated during the testing could be taken and used in schemes in the future. It showed that ACS could be used to maintain connectivity with the different bearers along the trackside to ensure continuity of communications, rather than rely on a single bearer, for example GSM-R. The two ETCS trains were able to run safely, and much closer together than on a conventional track layout, demonstrating the capability to increase the throughput of trains over this section of ETCS track. By using the CR940 capability it proved that it is possible to use Train Integrity to confirm the rear end of the train and being able to remove trackside train detection equipment, such as axle counters, by using the train position reports from the Moving Block system, thus saving money and increasing overall system reliability and performance. The ITD supports the move towards ETCS L3 or any of the steps in between depending on the choice of the IM and RU. It showed the benefits of reducing the track sections to allow the increased through-put of trains in an area with ETCS and Moving Block. Using the capabilities demonstrated during the ITD you can shape the railway environment throughout GB to overcome bottle necks and provide a safer more reliable and efficient railway. The customer can design the system to suit their requirements, using the building blocks provided.

The ITD successfully demonstrated the integration and operation of the technologies mentioned above and showed the individual capabilities working together, in harmony, in an operational railway environment.

1.2.3. IP3 Cost-Efficient and Reliable High-Capacity Infrastructure

The picture below provides a visual of the TDs where improvements are expected.

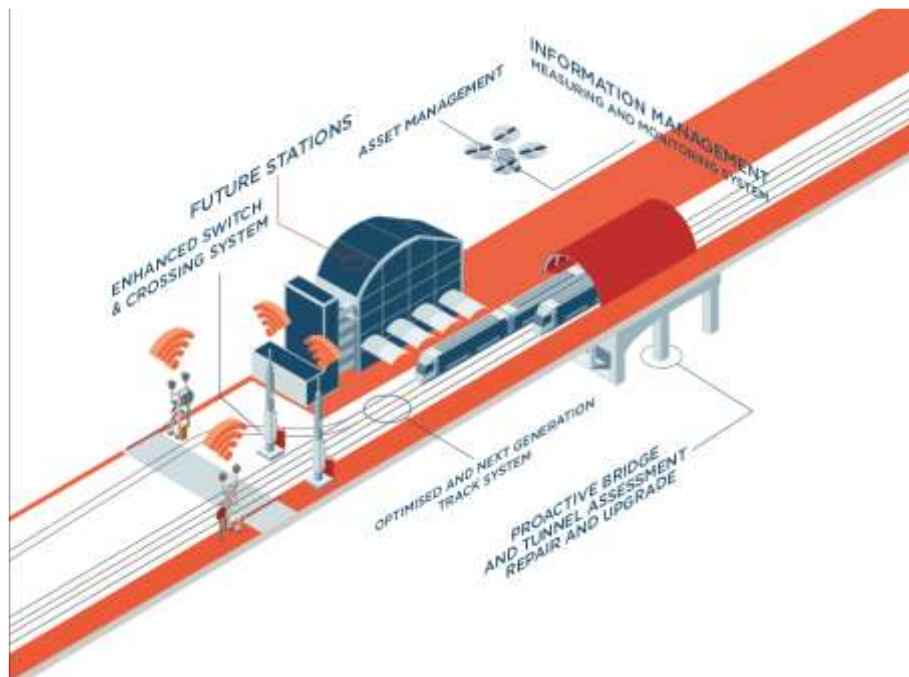

The design, construction, operation and maintenance of rail network infrastructure have to be safe, reliable, supportive of customer needs, cost-effective and sustainable. In order to deliver the benefits of market opening and interoperability and to reduce the life cycle costs of rolling stock and on-board signalling systems, the network diversity needs to be eliminated, notably through a migration towards common high-performing infrastructure system architecture.

Activities that can support the reduction of infrastructure maintenance costs, such as simplified procedures or automation, need to be led in priority. They should propose solutions that can be rapidly and efficiently deployed. Furthermore, the infrastructures have to be managed in a more holistic and intelligent way using lean operational practices and smart technologies that can ultimately contribute to improving the reliability

and responsiveness of customer service, as well as the capacity and the whole economics of rail transportation.

In order to be competitive with other modes but also integrated with them, compatibility between different modal infrastructures (including multimodal hubs, changing points and stations) needs to be ensured and based on principles of interoperability and standardisation.

The picture below shows the interconnections and dependencies within the IP3.

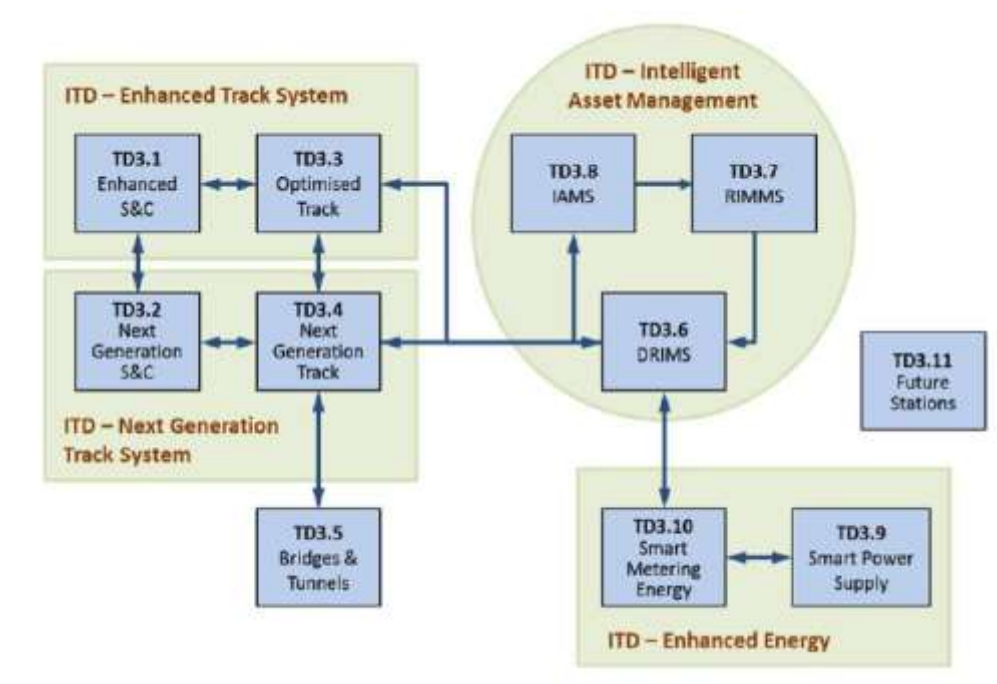

TD3.1 Enhanced Switch & Crossing System Demonstrator

TD3.1 aims at improving the operational performance of existing Switches and Crossings (S&C) designs through the delivery of new S&C sub-systems with enhanced Reliability, Availability, Maintainability and Safety (RAMS), improved Life Cycle Cost (LCC), sensing and monitoring capabilities, self-adjustment, noise and vibration performance, interoperability and modularity.

TD Progress

TD3.1 builds on the following projects: IN2RAIL, IN2TRACK and IN2TRACK-2 (completed projects), IN2TRACK-3.

In 2022, several **enhanced S&C demonstrators** are in-field equipped with extensive measurement continuously generating data for technology evaluation:

- The demonstrator of welded bainitic-steel components is being tested under operational environment since March 2022. Regular visual inspections and qualitative assessments of the welds, the geometry and the hardness are being carried out: the preliminary results meet the design requirements and currently demonstrate the suitability of welded bainitic-steel solution. In 2023, fatigue test of the welding will be performed to finalize the assessment of the demonstrator. The introduction of welded bainitic-steel components will reduce the occurrences of broken welding generated by the formation of a martensitic fragile structure on the three metallic steel types commonly used by crossing manufacturers (perlitic steel, austenitic stainless steel, austenitic manganese steel)
- Three different turnout frogs designs were being developed and numerically validated. One of the designs showed poor results, which haven't qualified for further testing. One of the designs is installed for validation and evaluation in field with the focus on fatigue under real operational conditions;

- VARS enhanced switch & crossing, equipped with extended Data Acquisition System are continuously gathering data both of the S2R turnout and the reference turnout and outcome currently demonstrate better results for the enhanced S&Cs, in some aspect beyond the initial requirements.

The **whole system modelling approach** including hybrid testing approaches for virtual evaluation and design of S&C were developed and have been validated with data from real-world operations from the VARS enhanced S&C Systems.

During 2022, one deliverable was planned and released. TD3.1 has reported having accomplished 100% of the planned work in 2022, which represent 85% of the overall TD3.1.

TD3.1 Enhanced Switch & Crossing System									
2015	2016	2017	2018	2019	2020	2021	2022	2023	...
Finished: In2Rail, IN2TRACK, IN2TRACK2							Ongoing: IN2TRACK 3		

TD 3.2 Next Generations Switch & Crossing System Demonstrator

TD3.2 aims to provide radically new system solutions that deliver novel methods for directing trains between tracks to unlock additional network capacity, while reducing maintenance needs, traffic disturbances and life cycle costs. Step-change solutions are prioritised over short-term incremental improvements. However, it must be recognised that incremental changes to the current switch and crossing design will need to be progressively introduced and a transitional approach adopted. This will enable a change from current design forms to a radical shift to a new approach in transferring trains between tracks in a +40-year horizon view.

TD Progress

TD3.2 builds on the following projects: IN2RAIL, S-CODE and IN2TRACK-2 (completed projects), IN2TRACK-3.

In 2022, further developments on the approximately 20 components/sub-systems in the scope of TD3.2 have been carried out. The list below summarizes some of the main achievements/issues:

- Development of the Reprint concept has continued through extensive design work focused on the drive system that will be housed in the hollow bearers. Computer models have been generated to assess the load characteristics that would be required by the system;
- The further development of the next generation switch control system prototype has shown good progress. Work has been completed to develop a remote node simulator and to integrate the communications protocol for this solution. The work has now entered the testing and evaluation phase and is due to be completed as planned;
- Development of a 3D printed/additively manufactured component solutions for S&C componentry has progressed well with work to optimise selected component designs being completed and examples being printed in a polymer form. The work is now moving towards 3D printing full scale versions of selected component solutions. These will form demonstrator outputs that are planned to be tested in accordance with current relevant EN standards to confirm their performance characteristics;
- A prototype of Radical tramway crossing has been manufactured following a FEM evaluation of the components and been carried potential lifespan. Installation and test under traffic are foreseen for 2023.
- The development of an automated repair system for crossings is progressing well. The Crossing Restoration Machine (CRM – an automated repair system for crossings) design has successfully completed factory acceptance testing. The programming of the machine software to recognise and be capable of recreating a crossing and wing rail profile has been successfully demonstrated on a piece of plain rail;
- However, the development of a vertical moving switch concept has been found to be unachievable due to the impossibility to find a suitable supplier to manufacture the proof of concept (mainly for budget/cooperation issues) and efforts will be reallocated to other promising developments.



During 2022, one deliverable was planned and released. TD3.2 has reported having accomplished 100% of the planned work in 2022, which represents 80% of the overall TD.

TD3.2 Next Generations Switch & Crossing System Demonstrator									
2015	2016	2017	2018	2019	2020	2021	2022	2023	...
Finished: In2Rail, S-Code, IN2TRACK2							Ongoing: IN2TRACK 3		

TD3.3 Optimised Track System

The TD challenges track construction assumptions, currently implicit in track design, and explore how innovative solutions in the form of products, processes and procedures can provide enhanced reliability, availability, sustainability, fewer capacity consumptions together with LCC savings. The aim is to derive medium-term solutions thus requiring harmonisation with current solutions and regulations. The TD also pays attention to the wheel/rail interaction that needs to work properly for a good performance of the entire railway system. The environmental aspect is also involved in his TD.

TD3.3 builds on the following projects: IN2RAIL, IN2TRACK and IN2TRACK-2 (completed projects), IN2TRACK-3.

In 2022, further development on the various TD3.3 demonstrators have been carried out. The list below summarizes some of the main achievements:

- The 3MB innovative slab-track solution has been installed during the autumn 2022 and is now in operation in Northern Sweden under harsh climate conditions and exposed to 31 tons of axle load. This track test includes track section of 48m and two embedded transition zones of each 14m. The system is instrumented, and the performance currently evaluated.
- A vehicle in commercial service has been equipped for demonstration on how defects in rails (rolling contact fatigue) can be identified thanks to onboard sensors. Data is currently collected from the test runs and from the infrastructure to investigate the potential of the solution.
- Progress has been made in improving the knowledge of the wheel/rail system conditions in terms of how the wheel profile will affect the stability on track for high speeds vehicles. A wheel profile for passenger vehicles is now in service for assessment of the performance considering stability on track by an onboard monitoring system.

During 2022, 3 deliverables were planned and released. TD3.3 has reported having accomplished 100% of the planned work in 2022, which represents 85% of the overall TD.

TD3.3 Optimised Track System									
2015	2016	2017	2018	2019	2020	2021	2022	2023	...
Finished: In2Rail, IN2TRACK, IN2TRACK2							Ongoing: IN2TRACK 3		

TD3.4 Next Generation Track System

TD3.4 aims to provide solutions that improve the plain line track system substantially, targeting a time horizon of around forty years beyond the current state-of-the art. The improvements are planned for delivery through the development of novel sub-systems and components, combined with more efficient and targeted inspection and maintenance processes. Step-change solutions are prioritised over short-term incremental improvements and as such, a longer-term implementation timescale is envisaged for the majority of technologies developed.

TD Progress

TD3.4 builds on the following projects: IN2RAIL, IN2TRACK and IN2TRACK-2 (completed projects), IN2TRACK-3 and IN2ZONE.

In 2022, further development on the various TD3.4 demonstrators have been carried out. The list below summarizes some of the main achievements:

- Development of a prototype next generation track transition zone system has been carried out, to provide a significant improvement in track support conditions, with fewer maintenance interventions compared with existing solutions. Three sleeper concepts have been designed and manufactured; two mechanical self-levelling sleepers, together with a wedge-shaped sleeper. Numerical analysis of the proposed sleeper models has been carried out, to assess the behaviour of the sleeper and ballast for each transition zone solution - the main geometrical parameters of the self-levelling cone sleeper were improved as a result. Full-scale laboratory experiments of transition zones were performed on standard plastic and wedge-shaped sleepers;
- Development of a novel method of slab track repair, that facilitates the debonding process, for efficient replacement of one or more modules within compatible slab track designs. A microwave heating device has been manufactured and five types of grout material have been tested, to determine the optimum for the slab track design;
- Development of an innovative self-sensing cementitious geocomposite, for continuous monitoring and damage identification has been done. Laboratory physical models have been produced and tests were performed, to optimise the geocomposite and instrumentation system, and establish the in-situ feasibility of using fibre-based sensors for on-line continuous monitoring;
- An innovative prediction tool based on a semi-analytical/numerical layer modelling the subsystems of the railway infrastructure, a surrogate model to have a quick-to-compute engine and a user-friendly graphical interface has been developed, to allow efficient assessment of ground-borne vibrations inside buildings, due to adjacent railway operations. Parametric studies were performed for different types of rolling stock, infrastructure and geotechnical conditions, together with automatization of a 2.5D FEM-PML numerical approach for the simulation of the track-ground system. A hybrid soil-structure interaction approach has been developed for the assessment of vibrations in buildings; The validation of the tool (accuracy and robustness) will be carried on in 2023.
- A motorised trolley, using a contactless ultrasonic method of identifying rail surface defects applying electro-magnetic acoustic transducers (EMAT) has been further developed and validated in 2022. Design validation of equipment, along with enhancements to rail detection algorithm have been achieved. Field tests are being arranged for early 2023 along with the manufacturing of the proposed trolley modifications, to validate the technical solutions. Lab test results have already allowed to take corrective actions to ensure a better positioning of the EMAT as well as improving its stability.
- Development of a method of track stiffness monitoring that can simultaneously assess the stiffness of the rail pad and ballast from the axle box accelerations (ABA) measured from in-service trains. A comprehensive field test campaign was carried out using three different measurement techniques and the vehicle-track interaction (VTI) model has been validated;
- Research on innovative low preheat automated process for the repair of discrete defects on rails has continued in 2022 with the full automation of the repair process of the Discrete Defect Repair (DDR), once located over the defect.

During 2022, 6 deliverables were planned and released. TD3.4 has reported having accomplished 100% of the planned work in 2022, which represents 80% of the overall TD.

TD3.4 Next Generation Track System									
2015	2016	2017	2018	2019	2020	2021	2022	2023	...
Finished: In2Rail, IN2TRACK2							Ongoing: IN2ZONE, IN2TRACK 3		

TD3.5 Proactive Bridge and Tunnel Assessment, Repair and Upgrade Demonstrator

The main objective of the TD is to improve inspection methods and repair techniques in view of reducing costs, improving quality and extending the service life of existing structures. One of the main objectives also consists of reducing the cost for new bridges regarding bridge dynamics.

TD Progress

TD3.5 builds on the following projects: IN2RAIL, IN2TRACK, ASSETS4RAIL, IN2TRACK-2 (completed projects) and IN2TRACK-3.

A bridge strengthening technology for improving shear capacity has been developed. The strengthening technology can be applied without disturbing train traffic and it has successfully been verified in laboratory. Developed strengthening system may increase service loads on the bridge with approximately 5 tons per axle depending on the individual structure to be strengthened.

Technology to automate tunnel inspection including crack identification, classification and registration by using optical methods have been demonstrated. The technology can improve quality of inspection and reduce track possessions by 25% compared to manual inspection.

A technology to detect scour under bridges foundations by monitoring from the trains has been developed. A prototype for the technology has been developed and monitoring data have been compared to model results. The technology has the potential to increase passenger safety. The technology to identify remaining service life of bridges in terms of fatigue capacity has been further developed for higher accuracy. Additionally, technology has the potential of extending service life of critical bridges by up to 50 years. Existing codes for bridge dynamics and resonance have been evaluated by a probabilistic approach. The results form the baseline for coming proposals on changes to existing bridge code. The activity will lead to increased safety, and reduced costs, as well as emissions by up to 25% for new bridges.

During 2022, no deliverable was planned nor released. TD3.5 has reported having accomplished 100% of the planned work up to year end, which represents 85% of the overall TD.

TD3.5 Proactive Bridge and Tunnel Assessment, Repair and Upgrade Demonstrator									
2015	2016	2017	2018	2019	2020	2021	2022	2023	...
Finished: In2Rail, IN2TRACK, IN2TRACK2, Assets4Rail							Ongoing: IN2TRACK 3		

TD3.6 Dynamic Railway Information Management System (DRIMS) Demonstrator

The TD defines an innovative system for its management, processing and an analysis of railway infrastructure data obtained from TD3.7 (Railway Integrated Measuring and Monitoring System (RIMMS) Demonstrator). The aim is to provide high-quality input to TD3.8 Intelligent Asset Management Strategies (IAMS). The main goal of these three TDs is to create new and optimised strategies, frameworks, processes and methodologies, tools, products and systems for the implementation of a step change in risk based, prescriptive and holistic asset management in the rail sector.

TD Progress

TD3.6 builds on the following projects: IN2RAIL, IN2SMART and IN2DREAMS (completed projects), IN2SMART2 and DAYDREAMS.

The preparatory work carried out in 2020 and 2021, based on historical data analysis and simulations, paved the way for the development of Machine Learning models that in this year have been tested against "real/live" data to refine the methodologies applied, fine-tune the algorithms and validate the results based on the feedback coming from the end-users. Multiple anomaly detection and prediction algorithms have been deployed in different scenarios and targeting different assets (e.g. Switch and Crossing) with very good results as for example the development of prescriptive algorithms for maintenance or the estimation of the asset's remaining useful life (RUL), an important KPI for the entity in charge of the maintenance of the infrastructure. As example of quantified results, the average percentage of corrective interventions (possibly generating service disruption) that could be avoided in April 2022 on the Metro de Milan Use Case (monitoring of Track Circuits and Wheel defects) and transferred into predictive intervention was evaluated at 54%.

Additionally, important results have been achieved in the application of BIM methodologies for the management of both wayside systems and rolling stocks or the optimised design and smart management of train depot, such as optimization of the tramways flows, estimation of the vehicle immobilisation time or energy saving opportunities in depot.

In 2022, dynamic, context-aware, and integrated HMI have been developed for the different use cases and for the Integrated Demonstrator, highlighting the possibility of data exchange among different stakeholders in CDM format and using the Integration Layer.

The main developments regarding TD3.6 are then summarized in the following:

- Big Data platform deployment in operational environment, with connection tested with all different data sources;
- Fine-tuning of data collection, cleaning and storage pipelines. Live data have been used to test and validate the models implemented using historical data and are now available for visualization purposes;
- Deployment of analytic models and algorithms and validation in the operational environment. Different analytic methodologies have been tested and optimized by adding new data sources, such as weather data. Validation of the different algorithms has been performed against the specific KPIs and the resulting models have been deployed in the respective scenarios;
- Deployment of DSS modules and dynamic HMIs to the different Ims, with feedback coming from the end-user and integrated in the validation process.

During 2022, 37 deliverables were planned out of which 30 were released. TD3.6 has reported having accomplished 75% of the planned work in 2022, which represents 90% of the overall TD.

TD3.6 Dynamic Railway Information Management System (DRIMS)									
2015	2016	2017	2018	2019	2020	2021	2022	2023	...
		Finished: IN2SMART, IN2DREAMS				Ongoing: IN2SMART 2, DAYDREAMS			

TD3.7 Railway Integrated Measuring and Monitoring System (RIMMS) Demonstrator

The TD aims at providing innovative tools and techniques to capture information on the current status of infrastructure assets in a non-intrusive and fully integrated manner. To this end, the TD focuses on infrastructure asset status data collection in close interaction with TD3.1 Enhanced Switch & Crossing System Demonstrator and TD3.5. Proactive Bridge and Tunnel Assessment, Repair and Upgrade Demonstrator.

TD Progress

TD3.7 builds on the following projects: IN2RAIL, ASSETS4RAIL and IN2SMART (completed projects), IN2SMART2.

In 2022, the TD achieved the collection of datasets covering the whole span of a year and that were significantly less impacted by the consequences of the COVID pandemic, bearing in mind that the vast majority of in-field installations across all the IAMS Use Cases were performed during 2021. For example, it was possible to monitor the variation of the number of passengers estimated from the weight measured by the WIM system across the different months of the year and extract useful and cost-saving insights for the Infrastructure Manager to optimize the scheduling of maintenance activities.

Pipelines for data collection, cleaning and processing have advanced across the different use cases of the TD and are now fully operational and integrated in the workflow of the different scenarios. The development of analytics and decision support systems carried out within the scope of TD3.6 has benefited from the results achieved within this TD

During 2022 the data collection processes coming from the on-board devices installed on the trains have been fine-tuned and multiple validation tests have been performed. The implementation of innovative and state-of-the-art methodologies, such as the application of the Eddy current to detect rail fasteners anomalies, has allowed to overcome major issues related to exogenous or environmental features that

were previously impacting greatly the maintenance processes. Additionally, the resulting datasets collected have been analysed to provide support to the maintenance procedure of the different IMs.

During 2022, 22 deliverables were planned out of which 14 were released. TD3.7 has reported having accomplished 60% of the planned work in 2022, which represents 90% of the overall TD.

TD3.7 Railway Integrated Measuring and Monitoring System (RIMMS)									
2015	2016	2017	2018	2019	2020	2021	2022	2023	...
Finished: In2Rail, IN2SMART, MOMIT, Assets4Rail							Ongoing: IN2SMART 2		

TD3.8 Intelligent Asset Management Strategies (IAMS)

The vision of the TD is a holistic, whole-system approach of asset management employing collected and processed infrastructure data provided by TD3.7 Railway Integrated Measuring and Monitoring System (RIMMS) Demonstrator and TD3.6 Dynamic Railway Information Management System (DRIMS) Demonstrator. This includes translating long-term strategies into day-to-day execution of the maintenance and other short term maintenance activities. It also includes new and advanced working methods, tools and equipment and logistics solutions, supporting the LEAN execution of intelligent maintenance processes.

TD Progress

TD3.8 builds on the following projects: IN2RAIL and IN2SMART (completed projects), IN2SMART2, DAYDREAMS and STREAM.

Decision-making use cases in 2022

In one use case (asset management in a Dutch environment) two examples of decision making based on the available data came forward:

- One focused on operational planning and one on long-term work planning. For the first example a case for specific isolation, a service to plan tamping activities allowing to quantify possessions, resources, costs and priorities. This is the basis for more complex possession planning taking other activities into account. In this case the asset status is based on data acquisition (TD3.7) and data analytics (TD3.6). Demonstration of the tool was finalized in 2022 with the positive assessment of the planning users.
- The second case is about long-term work planning: This includes the creation of an interactive visualization tool for the long-term work planning and the development of a decision support algorithm to help plan the work of existing projects and evaluate the choice of new projects already planned. Demonstration of the tool was finalised with the positive assessment of the planning users and the start of handing over results for deployment started.

In a second use case (Italian Urban Metro System IAMS), it was possible to deploy and test a Decision Support Module which provided support to the IM in planning both long term and short-term activities during 2022. The main applications deployed on this scenario are:

- Short Term Planning: the system provides, based on the results of the analytics of TD3.6, the prioritization of interventions depending on asset status and criticality; additionally, different plans are provided by the module to satisfy different KPIs that have been defined by the IM. The operator can also visualize the proposed weekly plan as recommendation and the plan adaption on a daily basis to adapt the weekly plan in case of corrective maintenance or unexpected events;
- Long Term Planning: the system provides also functional long-term planning, mainly focused on the allocation of extraordinary maintenance interventions that require additional possession times, as well as the impact of the activity on the line and a planning of alternative transport services;

Maintenance activities information are integrated with dynamic status of assets provided by the analytics and the available historical data on the passengers' flow in order to optimize intervention and allocate them in time interval with the lowest impact.

LEAN execution work in 2022:

Further development of the command-and-control architecture using the ROS (Robotic Operating System) framework and an off-the-shelf unmanned ground vehicle up to TRL7. This has been showcased during a track possession: North Hampton & Lamport Railway. The test showed that the use of the platform works over longer distances: to show that communication, navigation and location systems worked in this outside environment. As the inspection being carried out, have been shown in a proper railway environment. The platform consists of a Warthog (the unmanned ground vehicle) and a track trolley to enable the Warthog to move on the track. A stereo depth camera detecting track and track-side obstacles. For inspection sensors a robotic arm is mounted to the Warthog.

The development of and end-effector using similar robotic principles (for future integration): After the decision to replace the development of the mobile system of a Water Jet Cutter with an end-effector that can screw and unscrew the bolts of rail fasteners (higher market potential), work was developed rapidly. First version was tested. This test was successful, but also indicated points for further improvements. This has led to a minor delay – due to availability of components needed – but a final version of the robot was developed and tested in 2022.

Implementation of the On-Track Autonomous Multipurpose Mobile Manipulator (OTA3M) system, that includes hardware design, sensors, and software to develop autonomy and perception capabilities compatible to any rail-road excavator. Focus was on two modes: executing a task and the mode when excavator moves along the track. The system is being able to detect moving objects (humans) and anticipate to that. Also, avoidance of collision with stationary objects is implemented (such as catenary and catenary poles).

Design and development of the MMPE, an exoskeleton to be worn by railway workers who handle heavy tasks to minimize their muscular fatigue. The device is compliant to safety requirements accordingly with the Machinery Directive. The prototype has been developed, demonstrated, and tested with the project partners (STREAM). Performance assessments have been carried out showing for example that the ergonomic risk for “gross” positioning, lifting, and carrying goods, is reduced by 52%, meaning from high to low risk.

During 2022, 45 deliverables were planned out of which 30 were released. TD3.8 has reported having accomplished 70% of the planned work in 2022, which represents 85% of the overall TD.

TD3.8 Intelligent Asset Management Strategies (IAMS)									
2015	2016	2017	2018	2019	2020	2021	2022	2023	...
Finished: In2Rail, IN2SMART					Ongoing: IN2SMART 2, STREAM				

TD3.9 Smart Power Supply Demonstrator

The global objective of the Smart Power Supply Demonstrator is to develop a railway power grid in an overall interconnected and communicating system. This will enable improvements and optimizations regarding train traffic capacity, energy losses and costs, energy supply security and availability for the railway system and environmental impact.

TD Progress

In 2022, the TD3.9 builds on the following projects: FUNDRES and IN2RAIL (completed projects) and IN2STEMPO.

The smart control and protection demonstrator has been further pushed to implementation by testing on several layers.

The demonstrator will upgrade the station control systems within 16,7 Hz railway networks, introducing IEC 61850 and process bus. Especially process bus is a new communication network type, installed between IED (e.g. protection devices) and Merging Units (measuring devices for voltage and current). Process bus reduces the wiring effort significantly and enables new protection concepts.

Starting with component tests for specific adapted devices and intensive functional tests for the innovative process bus communication technology. Afterwards, protection and system tests as well as FAT have been conducted for the complete control and protection equipment leading to the achievement of a TRL5 already.

The application of the smart control and protection demonstrator to trial operation in an actual switch gear station is however delayed: For the integration of the demonstrator into the switchgear station specific cables were needed. Several tenders for these suitable cables have not led to any economical reasonable offer and prevented the start of the trial operation. Even though, the demonstrator is manufactured and completely tested, it cannot be installed due these missing cables. In consequence a new, more suitable installation site with a different connection possibility (e.g., using overhead lines instead) will be chosen. The trial operation will be conducted by DB Energie GmbH beyond the project phase.

The FACTS demonstrator consisting of several simulation models, including extensive real-time simulations, has been finished with the planned status. An application guideline has been created to support operators with the choice and specification of a FACTS solution in their system. Additionally, general certification requirements for FACTS have been defined to ease the product market introduction. This work will be followed up by further demonstration in the new EU-Rail project FP4-Rail4Earth that already started.

During 2022, 3 deliverables were planned out of which 2 were released. TD3.9 has reported having accomplished 70% of the planned work in 2022, which represents 85% of the overall TD.

TD3.9 Smart Power Supply										
2015	2016	2017	2018	2019	2020	2021	2022	2023	...	
Finished: In2Rail, FUNDRES										
							Ongoing: IN2STEMPO			

TD3.10 Smart Metering for Railway Distributed Energy Resource Management System Demonstrator

The objective of the Smart Metering Demonstrator is to achieve a fine mapping of energy flows within the entire railway system, as a basis of any energy management strategy.

TD Progress

TD3.10 builds on the following projects: IN2RAIL and IN2DREAMS (completed projects) and IN2STEMPO.

In 2022, the Smart Metering concept has been implemented and validated in the 3 following use cases: Use case 1: Commercially Operated line (CO-OP) Use Case on a line in commercial operation south of London; Use case 2: Stationing and Maintenance facilities operation (STM-OP) Use Case in the Saragossa tramway depot; Use case 3: Electrical Infrastructure monitoring (IN-OP) Use Case on the London North Westcoast mainline.

Summary of results for UC1:

The Smart Metering systems installed on the three sites provided a large amount of significant and reliable data to perform analysis. The re-host of the database and the replication of dashboards developed earlier in IN2DREAMS Open Call project has been finalised within the targeted ODM (Operational Data Management), to be able to display power flows and energy on the line, from the beginning of meters implementation. User applications and benefits have been assessed for CO-OP use case, among other:

- The use of Smart meters supports a better management and utilization of energy such as reduction in energy losses, better distributed power demand, etc.;
- Online based applications and dashboards help to have a real-time asset management.

Summary of results for UC2:

In the STM-OP use case, consistent and substantial data sets have been recorded over the last years from the Zaragoza tram depot. Benefits were shown as follows:

- Improved maintenance plan based by better identification of malfunctioning of the track switches;

- Improved reliability based on predictive maintenance by continuous supervision;
- Better identification of electric infrastructure losses on infrastructure.

Summary of results for UC3:

Dashboards have been developed to monitor electrical values from the railway power system. Trigger tests have also been performed to reduce the amount of data to be transmitted to the ODM. This enabled the transmission of high frequency voltages and currents acquisitions, for a limited period, only when a special event is detected. User applications and benefits have been assessed for IN-OP use case:

- Non-intrusive and simple installation of equipment allowing for access to real time information;
- Energy flow information can help identify opportunities for reducing losses;
- The detection of faults or abnormal events can help in improving asset management effectiveness, speed diagnose and system performance;
- Ease of accessing system parameters remotely could be used to reduce frequent maintenance of the infrastructure, and lower maintenance and infrastructure costs.

In this use case IN-OP, the transmission system has also been designed and configured to send data through two different streams. The first stream sends data flow to the common ODM. The second stream sends data to another data platform, part of the ITD Enhanced Energy, thus linking TD3.10 to TD3.9. This demonstrates that Smart Metering is an open system, able to connect to several platforms for different usage.

During 2022, 2 deliverables were planned out of which 2 were released. TD3.10 has reported having accomplished 100% of the planned work in 2022, which represents 100% of the overall TD.

TD3.10 Smart Metering for Railway Distributed Energy Resource Management System									
2015	2016	2017	2018	2019	2020	2021	2022	2023	...
Finished: IN2Rail, IN2DREAMS				Ongoing: IN2STEMPO					

TD3.11 Stations

The primary objective of the TD is improved customer experience at stations thus increasing the number of customers that will use rail as their preferred transport mode. The TD is organised around four identified key functional demands; two demands relate to improving capacity, safety and security in large stations, one demand relates to the design of small stations with the objective of reducing whole life costs and standardising design where possible and the final demand relates to platform to train accessibility.

TD Progress

TD3.11 builds on the following projects: FAIRSTATIONS (completed project), and IN2STEMPO.

In 2022, the TD updated the findings made within the EU funded project 'Secure Stations' that was completed in 2014 (Project No – FP7-SCPO-GA-2011-266202) in the areas of blast modelling, blast resistant glazing and CCTV security systems, which were not originally created for Secure Stations report. The updated material is contained an end user document to be used for dissemination and to integrate 3D interactive results of the blast model a document that provides additional dissemination with heightened visuals of blast modelling scenarios created to demonstrate the effects of explosive threats and some mitigation methods (e.g. more venting, surveillance, materials choice). The content will improve the safety and security at stations as part of TD3.11 objectives through the development of strategies for an improved safety management in public areas.

Regarding crowd management, the work within 2022 addressed the training- and forecast scenarios, elaborated earlier in 2021. The architecture of the prototype for a new generation of Operational Control Centre (OCC) used for these scenarios was finalized. It features (1) digital twin including 3D model and crowd simulation engine, (2) Video Content Analysis (VCA), (3) behaviour models, and (4) simulation calibration applying artificial intelligence (AI). Moreover, crowd simulation was calibrated with the VCA

results using AI and behaviour models and the operational prototype was employed within the real experiment at the Warsaw East station in November 2022.

A new ticketing technology using real-time train occupancy information has been validated, which will help to achieve optimal transit channels for passengers at the station. The system is integrating on board ticket validation and on-board passenger counting system.

Regarding design of small stations, the work within 2022 proposed and explored concrete solutions for passengers and for energy savings at small stations. These included (1) multifunctional furniture conceptualized for small buildings, (2) modular technological wall, (3) Navi Info component as navigation aid for the blind and visually impaired persons, and (4) E-ink module, also for integration into technological walls and energy reduction. Additionally, (5) various solutions for energy reductions have been proposed, not limited to the small stations. Furthermore, concrete digital solutions to solve the problem of high unit costs of building and operating passenger services at small stations were explored. These included (1) Building Management System (BMS), (2) Building Information Modelling (BIM), (3) use of 3D models and (4) new ticketing technologies, including train passenger occupancy.

During 2022, 6 deliverables were planned out of which 3 were released and are currently under assessment. TD3.11 has reported having accomplished 50% of the planned work in 2022, which represents 90% of the overall TD.

TD3.11 Stations										
2015	2016	2017	2018	2019	2020	2021	2022	2023	...	
			Finished: FAIRSTATIONS							
			Ongoing: IN2STEMPO							

1.2.4. IP4 IT Solutions for Attractive Railways Services

In order to become more attractive, rail must respond to customer needs to support seamless door-to-door multimodal journeys encompassing different modes of transport. Rail must achieve interoperability with other transport modes and mobility services, within different regions, cities and across borders. In view of this objective, rail needs to take due advantage of the ever-growing connectivity of people and objects, the availability of European Global Navigation Satellite System (GNSS) based location and other means of localisation, the advances in cloud computing, Open Data and Big Data Analytics and the wide dissemination of Internet and social media. Multimodal integration will also take benefit from existing rail standards as FSM and TAP TSI.

The picture below represents the areas where IP4 Technological Demonstrators will introduce improvements.



To achieve this, the IP4 ecosystem aims to integrate and make interoperable all possible transport modes and travel services: rail, urban transport (metro, tram, and buses), airlines, private cars (such as the use of

toll roads and parking, which have an associated price) and also shared modes (cars and bikes). Thus, multimodality and the use of public transport are being fostered, making it easier for travellers to connect with rail stations and airports, regardless of where and how they start their journey. For the future, Demand Responsive Transport and Ride Sharing will be included in the ecosystem to ease the access to everyone to long distance trips, even to those living in not well- connected areas.

IP4 Ecosystem has also evolved to implement at European Level the new Mobility-as-a-Service (MaaS) paradigm, which considers the mobility system as a whole in order to achieve an optimal and sustainable transport scheme. This way, the IP4 ecosystems facilitates the task to create formal contracts that could involve the agreements, business rules and financial compensation that shall occur between the different stakeholders when combining their services into a joint product. In the future, this component will evolve to be used also to create MaaS Packages that integrate a variety of transport services that could include multiple Transport Service Providers.

IP4 is organised around 7 Technological Demonstrators within three priority research and innovation areas as shown in the graph below.

- Technical Framework: Interoperability Framework and Business Analytics
- Multimodal Travel Services: Travel Shopping and Booking and Ticketing
- Customer Experience Applications: Travel Companion and Trip Tracker

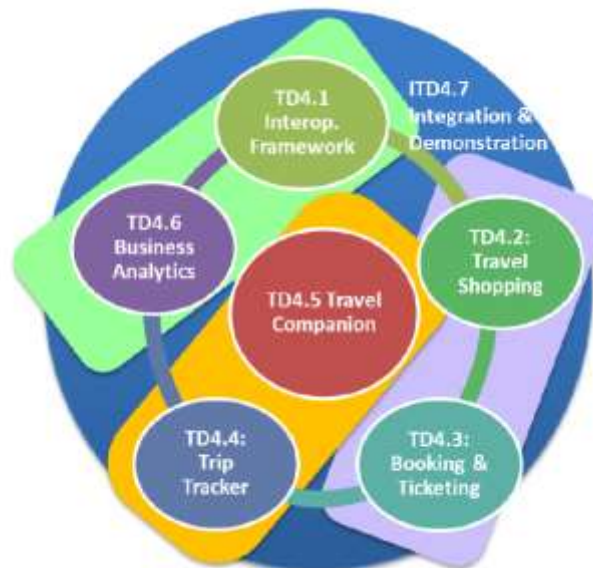

IP4 projects are contributing to developing innovations in each TD. All the outcomes of IP4 project will contribute to one single Integrated Technological Demonstrator (iT4.7), which will merge all the developments.

TD4.1 Interoperability Framework

The TD aims to facilitate multimodal travel in a highly diverse environment and with many transport modes. Interoperability at the semantic level defines formal and explicit models of the transportation domain in an open, standard, machine-readable language that is exchanged automatically by computers, therefore allowing seamless access to all transport data and services in a multimodal and distributed environment. Hence, TD4.1 is a key technology enabler for a complete transformation of the European transportation ecosystem.

TD Progress

The TD covers different aspects of the Interoperability Framework (IF), including the definition of architectural principles, the implementation of components with basic capabilities and the development of a reference ontology.

In 2022, the activities have been focused on F-REL of the Interoperability Framework, its final release. The CONNECTIVE project has finished the implementation of the F-REL Interoperability Framework (IF) based on the conclusions of the internal analysis carried out during the A-REL, which take into account the requirements and issues that have been identified during MaaSive. The issues found in the A-REL version of the IF and its improvement with the F-REL are reported in CONNECTIVE D1.3 – Architectural Principles and Design F-REL. After initial tests, the F-REL has demonstrated higher performance and scalability compared to A-REL, reported in D3.3, and based on positive user feedback from OC pilot activities in 2022, while with the previous A-REL version the feedback was not as positive. For example, the new version can process 25 parallel requests in 6 seconds, whereas the previous version could do merely 13.

Additionally, the new version requires less resources and allows for more flexibility thanks to the evolution of its internal components, making it more suitable for potential future market deployment.

The F-REL has been part of the third complete integration of the IP4 ecosystem as part of the FINAL RELEASE (2022) of COHESIVE. In addition, IF F-REL is compatible with developments carried out by SPRINT. Finally, the IF F-REL is more configurable compared to its previous versions and it facilitates the integration of transport services procedure, even though it still needs human effort to integrate them due to the lack of standardization on the market.

In addition, during 2022, the services provided by the Ride2Rail and IP4MaaS have been integrated to the Interoperability Framework and have been tested in the pilots (Athens, Helsinki and Brno). The integrated solution included six TSPs that provided Shopping, Booking and Issuing services, the functionalities and services provided by Extensive C-REL have been integrated to the Interoperability Framework and were demonstrated at InnoTrans 2022.

In terms of ontologies, the CONNECTIVE project has finalised the development of different modules of the modular ontology divided into subgroups that cover different aspects:

- The Infrastructure Static Data Module is based on Transmodel (Core, Commons, Journey and facilities).
- The Tariff module is based on Transmodel (Fare components, Controllable elements, Fare product, Sales and Ticketing equipment).
- The Online Distribution sub-module Online Distribution of OSDM (based on FSM) covers the communication to manage the sales process of transport offers.
- Real-Time based on TRIAS and GTFS-RT.

TD4.1 Interoperability Framework										
2015	2016	2017	2018	2019	2020	2021	2022	2023	...	
Finished: IT2RAIL, GOF4R, ST4RT, SPRINT				Ongoing: CONNECTIVE						

During 2022, 2 deliverables were planned out of which 1 was released. The results of the deliverables produced this year finalised the Specification of Final Release and its closure. Since the beginning, TD4.1 reports having accomplished 98% of the planned work up to the end of 2022, which represents approximately 91% of the overall TD objectives.

TD4.2 Travel Shopping

The concept of TD4.2 Travel Shopping is both to enable and to respond to an emerging single European multimodal transport marketplace within a Single European Transport Area (SETA). The IP4 approach will promote the integration of distributed travel operators' data and services and the orchestration of services such as expert journey planning and offer building for all modes. It will benefit from the Interoperability Framework that enables applications based upon different interfaces, standards, or coding lists, to communicate meaningfully but without costly application adaptations with the existing legacy systems of all stakeholders. The TD4.2 contribution to IP4 System is to enhance the technical facilitation of a one-stop-shop capability, to enable comprehensive choice of itineraries and offers from modes/operators capable of responding to customer mobility requests, especially using existing services from all stakeholders by interfacing their legacy systems.

TD Progress

Within the project MaaSive, the development of the general idea to plan a personalised Multimodal European wide Door to Door journey has mainly been finished. It is based on the Interoperability Framework (TD4.1) that enables Service Providers to be connected to the IP4 ecosystem. With this idea multimodality is implemented by design. To further prove that this system fulfils the expected outcome additional Travel Service Providers within the Open Calls IP4MaaS and Ride2Rail have been successfully integrated during 2022. The connection to the Drivers Module developed in Ride2Rail was also implemented in 2022.

It is obvious that having a pan European travel solution in mind hundreds of different Travel Service Providers needs to be attached to the ecosystem. It would take too much time to connect them manually. Within ExtenSive it was therefore decided to include a SaaS system into the ecosystem. This will enable specifically small providers to easily provide their services through the IP4 ecosystem. Development of this system is still ongoing and will be finished by the end of ExtenSive.

In regard to user-oriented functionality and user experience, several enhancements and improvements were developed within ExtenSive:

- The travel shopping algorithm was enhanced to also provide itineraries with bike and car (e.g. for the first mile).
- In addition, the travel shopping algorithm was extended to compute itineraries where a car (e.g. a rental car) is not only used for first/last mile but where it is used for the main part of the itinerary and complemented by public transport for the first/last mile.
- Clusters are used to categorize the travel shopping results by means of transport (e.g. a dedicated cluster for pure public transport trips and another separate cluster for itineraries that include bike legs).
- Users can now add a preferred stop to a favourite address so that travel solutions will be provided where boarding or alighting is done at the preferred stop if itineraries are computed from or to the favourite address, respectively. A favourite address combined with a preferred stop form a smart location that increase the comfort during travel shopping.
- The integration of a new IF version together with changes in the process of resolving meta routes led to improvements in the overall travel shopping performance.

TD4.2 Travel Shopping									
2015	2016	2017	2018	2019	2020	2021	2022	2023	...
Finished: IT2RAIL, Co-Active, MaaSive						Ongoing: ExtenSive, Ride2RAIL, IP4Maas			

The three deliverables expected for the period have been delivered. TD4.2 reports having accomplished 100% of the planned work up to the end of 2022, which represents 95% of the overall TD.

TD4.3 Booking & Ticketing

Today, even within a given mode of transport (air, rail, urban, etc.), the rights to travel have, in the best case, limited interoperability between the various travel service operators; and this interoperability is almost non-existent between the modes themselves. This TD aims to orchestrate multiple but parallel interactions with several booking, issuing, payment and ticketing engines, including the all-important roll-back activities. This will radically simplify the traveller's life, by abolishing uncertainties and complexities associated with 'behind-the-scenes' multiple booking, issuing, payment and ticketing processes.

TD Progress

The TD builds on the completed projects IT2RAIL, Co-Active and MaaSive and on the currently open projects ExtenSive and Ride2Rail. Activities in 2022 allowed to reach new implementation and integration of all components with other IP4 TDs, which was demonstrated at InnoTrans 2022 with Travel Service Providers (TSP) covering different transport modes.

Activities in 2022 have allowed enhancing the existing components, creating new ones. The work further focused on the implementation of a first round of ExtenSive Uses Cases and establishing the planned work to implement each of the functionalities.

In 2022, new use cases have been introduced such as including new payment and validation methods, inclusion of new functionalities on the CRM and Best Prices modules. In order to deliver such features, modifications in the orchestrators have been made. These updates are compatible with all pre-existing features so far developed involving the legacy system of the services tested in the pilots. All these software components contribute to the interoperability between the different TSP, orchestrating parallel interactions of different booking and ticketing engines seamlessly for the passenger.

Following current MaaS approaches, one of the objectives was to include, within the different flows of the IP4 ecosystem, the concept of Mobility Package as a kind of subscription or travel card that combines a number of transport products that could include different modes and operators. Thus, the possession of a Mobility Package by a user needs to be taken into account for example when calculating the price of the offer. By enabling the creation and consumption of these Mobility Packages, IP4 aims at changing traveller's behaviour towards more sustainable modes, offering better service and affordable mobility to reduce car ownership, but at the same time assuring the flexibility and convenience of a car.

The new Mobility Packages flow manages the lifecycle of Mobility Packages since its creation using the Contractual Management Marketplace (CMMP, presented in TD4.2) and its purchase through the Travel Companion, to its use at shopping and travelling time. Previously, TSPs had to provide Mobility product descriptions in NeTEx format, and in 2022, the flow was enhanced by allowing the description of Mobility products via the CMMP (Web) user interface in order to make this step more flexible and user friendly, and removing the need for TSPs to provide descriptions in NeTEx format, which was not always possible for certain TSPs.

The Generator token toolkit for operators has been improved and it has become a SaaS by developing the necessary backend in order to be used by different TSPs without needing a deployment on their infrastructure. This generic token toolkit consists of a Web Portal and a Configuration API that allows TSP to configure their own metadata (or use the generic metadata structure proposed) and embodiments. A metadata compiler will interpret the metadata, and feed token generation and validation modules in order to do the serialisation and deserialisation of the entitlement metadata.

Moreover, two new validation methods have been defined and its final implementation will be carried out in 2023. A validation based on the management of list of tickets that provides an alternative solution for TSPs that do not have such capacities. Moreover, a new validation method is being defined enabling ticket validation without physical interaction with the validation equipment.

Another area of work aims at providing the ecosystem with Customer Relationship Management (CRM) capabilities to improve the management of user information and to allow managing customer claims and passenger rights. A CRM has been developed with this aim, integrated with other existing components of IP4 such as the Cloud Wallet. During 2022, it has been designed and initial works have been carried out to improve the flexibility of the CRM by adding the role functionality to separate the functionalities provided to operators and the administrator of the site and a dashboard that shows the traceability of the services provided by each TSP. Moreover, Best Price functionality has been improved in order to allow post payment functionalities.

In 2022 the work focusing on starting the implementation of Uses Cases that were demonstrated at InnoTrans 2022.

TD4.3 Booking and Ticketing									
2015	2016	2017	2018	2019	2020	2021	2022	2023	...
Finished: IT2RAIL, Co-Active, MaaSive							Ongoing: ExtenSive, Ride2RAIL		

During 2022, no deliverable was planned. Since the beginning, TD4.3 has accomplished 100% of the planned work up to the end 2022, which represents approximately 95% of the overall TD.

TD4.4 Trip Tracker

The overall objective of the Trip Tracking system is to assist a traveller throughout his multimodal journey in respect to any obstacles that might occur during his trip. Technologies that accurately and timely notify the traveller of those unforeseen difficulties on individual trips will be used. In cases they arise alternative routes will be provided to limit any impacts on them. When a disruption occurs, Trip Tracker will provide

assistance by calculating with a multimodal approach both whole new itineraries door to door, and from the current position or even only single legs. It will analyse and correlate available static data (such as timetables), dynamic data (mainly real-time data) and passenger data (like preferences, locations). The architecture of Trip Tracking foresees not only to easily remove service providers and/or event sources but as well to add new and upcoming services is it a transport service provider or specific event sources bringing benefit to the travellers.

TD Progress

During the project phase of 2021 the projects CONNECTIVE and MaaSive had contributed to the Trip Tracking system. Main objective was a more flexible solution by integrating the Interoperability Framework for both partial Trip Tracker and Event Sources. This architectural modification has been finished and we are thus in line with the Shift2Rail MAAP.

The 2022 project period was characterised by supporting the Open Calls IP4MaaS and Ride2Rail.

The basic idea of a trip tracking system was designed already in the Lighthouse Project IT2RAIL comprising the activation, disruption detection and alternative managing of an itinerary. S2R IP4 project ATTRACKTIVE expanded the architecture of this trip tracking system to a modular one consisting of the Tracking Orchestrator, different partial Trip Trackers and the corresponding Event Source Management. Results were demonstrated through the final release of ATTRACKTIVE which is as well the Alpha release of COHESIVE on the final event of that project. The developed architecture of Trip Tracking was improved further, towards an even more flexible one. This was done by integrating it into the Interoperability Framework of the IP4 ecosystem. It enables the integration of a new partial Trip Tracker for new modes, new operators, or additional information for e.g., specific geographical areas without modification of the Tracking Orchestrator.

Within 2022 some minor stabilisation in cooperation with the CONNECTIVE project in respect to the integration of TT into the Interoperability Framework took place. For instance, the configuration of new partial Trip Trackers at the Tracking Orchestrator was improved. Instead of manually adding the endpoints of pTTs to a list that is read by the Tracking Orchestrator, the Tracking Orchestrator applies a dynamic look-up to get the current endpoints from the Travel Service Registry.

During 2022 there was no specific deliverable planned for TD4.4.

TD4.4 Trip Tracking									
2015	2016	2017	2018	2019	2020	2021	2022	2023	...
Finished: IT2RAIL, ATTRACKTIVE, MaaSive							Ongoing: Ride2Rail, ExtenSive		

The Trip Tracking system has an overall target of TRL6/7. Since the beginning TD4.4 has accomplished 100% of the planned work up to 2022, which represents 95 % of the overall TD. A few final tests and checks will be done till the end of ExtenSive in mid-2023.

TD4.5 Travel Companion

The overall objective of the TD 4.5 Travel Companion is to research, implement and evaluate a seamless and interoperable platform offering new levels of interaction between travellers and transport stakeholders along with an innovative ubiquitous adaptive front-end to the global transportation service ecosystem.

Thanks to their own personal and secured 'Travel Companion' travellers will have access to all travel services needed for the journey (shopping, booking, ticketing, trip tracking, preferences, cancellation, ancillary services as well as novel forms of experiences) which will extend and transform the journey to a real door to door experience.

TD Progress

Based on the specification developed in 2021, implementation work was carried out in 2022.

A new collaborative space was implemented to provide new user interface for travellers to report their feedback. The travellers are now able to:

- Report delays (due to accident, traffic, contractions, ...)
- Report overcrowding (in a station or in a vehicle)
- Report about security constrains (in a station or in a vehicle)
- Report on the quality of a transport service
- Identify and see reports around
- Contribute to the reports already present
- From TSP side the tool focused on the TSP analysis of data generated by the collaborative tools for the travellers, where they can report events happening around them to:
 - Visualization of events
 - Creation/Manage events
 - See statistics
 - Request feedback
 - See feedback statistics

In the same way, a new map interface was implemented. This new module will allow travellers to navigate within the map and manage their interactions. A new dynamic map display was developed to provide a clear view not cluttered by location objects. It applies clustering and thinning out to POIs and stops/stations taking into account the current zoom level. An additional function features the smart locations enabling a user to associate a preferred stop with a favourite address. The travel shopping service will then compute itineraries where the user boards/alights from the preferred stop when the favourite address is selected as start/destination.

Activities were also performed on the web front end. Initially created in other S2R projects, this module allows users to access services using a web browser with a double identification factor for registration in a simple interface. ExtenSive has enhanced the registration of new users and authentication methods by including Google account, also allowing payment of both travel offers and Mobility Packages with different payment methods.

Finally, a new orchestration tool was implemented. This desktop application dedicated to the TSPs for real time travellers' supervision and POI management allowing the display of travellers and network status allows the four functionalities:

- SCORE sharing;
- The tool manages the different interactions between the travellers during their entertainment solutions;
- Meeting Point;
- Allows TSP to create Meeting point and share this meeting points with the travellers. On the TC, the travellers can reach the meeting point;
- This meeting point is recorded by the TSPs in different stations using the orchestration tool;
- When travelling in groups, travellers can access to the meeting point functionality. When the request is launched, the orchestrator calculates the nearest meeting point and shares this meeting points with the travellers and the selected members of the group. Instructions are then provided about the meeting point to allow travellers to meet in augmented reality using HoloLens;
- Specific Messages;
- When the TC is on the travellers are geolocated on the map to allow the TSP to interact with them;
- POIs;
- Allows the TSP to add POIs in the map and share them with the travellers.

Moreover, the storage of POIs and the process for displaying them to the TSP was implemented. Similarly, the display of travellers on the interface and the mechanism for interacting with them by sending messages was implemented and tested as well.

Thanks to these achievements, a demonstration was performed at InnoTrans 2022 with the travel companion personal application.

Based on the orchestration and supervision tool, different meetings points were created throughout the fair and with the connection to the travel companion and the HoloLens travellers were guided through the exhibition grounds.

In term of interaction with IP3, ExtenSive was working on the station to use for the tests. Pomiechówek station in Poland was the one selected. The Information Reliability Evaluation System (IRES) was defined and the information to be used was clarified. This IRES system will serve as well for the interaction with the TVM.

The IRES will allow the connection between the TC PA and the vending machine, to allow the travellers to print their already booked ticket.

In addition, particular attention was paid to the collaboration with the open call project Ride2Rail in order to be able to deliver the project functionalities integrated and test, to be ready for their scheduled Pilots. The ExtenSive functionalities were discussed and a set on functions were identified to be piloted.

TD4.5 Travel Companion									
2015	2016	2017	2018	2019	2020	2021	2022	2023	...
Finished: IT2RAIL, ATTRACTIVE, MaaSive, My-TRAC						Ongoing: RIDE2RAIL, EXTENSIVE			

During 2022, 3 deliverables were planned out of which two were released. Since the beginning, TD4.5 has accomplished 100% of the planned work up to the end of 2022, which represents 95% of the overall TD.

TD4.6 Business Analytics

The TD will provide a common business intelligence foundation for all products and services transport providers based on the access to open-ended web of transportation data offered by the Interoperability Framework (TD4.1).

Based on descriptive, predictive, and prescriptive analytics using multimodal data sets generated by the Travel Service Providers and by the services developed in IP4, the TD will help the passenger carriers to better adapt their level of service to the passengers' demand and to optimize their operations. TD4.6 will also provide interactive and dynamic visualization capabilities.

TD4.6 cooperated with IP2 on specifying a solution on how to exchange data. The value of exchanging new data sets and information about passenger demand and transport supply capacity will be demonstrated in the Use Case to be implemented in 2022. The objective is to implement vehicle occupancy predictive analytics and on dwell times at stations, impacted by fluctuating passenger flows. By exchanging in real-time the information within all subsystems, prescriptive analytics will be developed for example for Train Management Supervision Systems (TMS) for real-time timetable optimization based on the demand (demand-based operations).

Data privacy is also an important issue in transportation: European GDPR – General Data Protection Regulation is effective since May 2018 and before GDPR adoption, other regulations were applied in the transportation context. To this end, anonymization services will be developed to guarantee privacy and confidentiality.

TD Progress

The TD R&I activities in 2022 relied on works performed in CONNECTIVE project (since 2017) and also in EXTENSIVE project (since 2021).

The TD adopts two approaches to develop Business Analytics. The first is a top-down approach: it aims to identify what information operators would value, regardless of any existing implementation and any data availability. This method is complemented with a bottom-up approach which aims at managing real data from real operators, to be able to build robust big data platforms and to propose rich algorithms.

Based on interviews with stakeholders (CFM and OC projects, Rail Delivery Group and Rail Safety and Standards Board in UK), the top-down approach identified 47 use cases of interest for Business. A finer

analysis, based on the answers to the questionnaire and interviews with stakeholders, has been done to rank them and prioritize them. The most pertinent use cases are highlighted in red in the table below.

1. Service Quality	2. Service Performance	3. Station Management	4. Resource Management	5. Demand Management	6. Revenue Collection & Distribution	7. Marketing
The door-to-door passenger experience on public transport and at transport terminals.	Optimize public transport service to increase reliability and punctuality.	Manage transport terminals to improve passenger flow, reduce crowding and increase safety.	Optimize distribution and allocation of resources to increase efficiency whilst also considering sustainability and cost.	Understand patterns of demand and feed into timetables, scheduling & routing.	Provide better information about passenger travel to distribute revenue accordingly.	Improve the passenger experience whilst also providing extra levels of revenue.
1.1 Accurate journey time prediction	2.1 Mitigate network disruption through personalized communications	3.1 Station digital twin	4.1 Environmental impact of journeys	5.1 Set fare prices to manage demand	6.1 Reduce fare avoidance	7.1 Improve effectiveness of advertising
1.2 Real-time train availability	2.2 Real-time prediction of delays	3.2 Real-time station heat map	4.2 Improve energy efficiency	5.2 Manage demand in response to predicted delays	6.2 Fare avoidance surveillance	7.2 Target advertising by passenger location
1.3 Improve level crossing safety	2.3 Management of track speed restrictions	3.3 Real-time carriage occupancy	4.3 Improve allocation of staff	5.3 Target messages and advertising to reduce overcrowding due to planned events	6.3 Faster ticket pricing	7.3 Target advertising of station facilities & businesses
1.4 Improve trackside worker safety	2.4 Analysis of impact of delays on passenger	3.4 Dynamic indication of door positions	4.4 Improve alignment of rolling stock	5.4 Analysis of multimodal journeys from origin to destination	6.4 Improved sales information	7.4 Target advertising of events
1.5 Detection of left objects and suspicious behaviour	2.5 Improve response of short-term planning for delays	3.5 Retail offers for delayed passengers	4.5 Identify vehicle for customer problem-reporting apps	5.5 Data-driven instant timetabling	6.5 Revenue allocation	
1.6 Improve support for passengers with disabilities	2.6 Predict and mitigate reactionary delays	3.6 Video-stream monitoring for crowd management	4.6 Monitor fare collection equipment	5.6 Manage operator timetable variation requests		
1.7 Track car park usage	2.7 Predict station dwell time fluctuations	3.7 Real-time optimized platform allocation		5.7 Modelling of impact of commuter hour changes		
1.8 Track in-use usage	2.8 Real-time digital network twin					
1.9 Improve passenger distribution on trains						
1.10 Understand use of trip tracking						

In 2022, for these 'top' use cases, further analysis has been completed. First, a use case template has been proposed to describe each use case to a certain level of detail and to ensure that the necessary information is gathered to cover all aspects of the use case. Based on these results, a scoring methodology has been developed to consider three general aspects of a use case: Value (monetary or otherwise) that the use case is expected to deliver, Data Readiness (the preparedness of the data sources needed for the use case) and Implementation (what effort and resources it would take to develop and operate an implementation of the use case). Results are displayed in the table below.

The last column (Implementation Leader (bottom-up)) of the table represents the results of the comparison between the top-down and bottom-up approaches and the proximity between the use cases developed in the two methods.

As a reminder, the bottom-up use cases aim at: optimizing timetables and adapting dwelling time in station, regarding the predicted demand; optimizing bus route planning regarding multimodal transport offer; minimizing impact of maintenance activities on the railway attractiveness.

Total Score (Top-down)	UC ID	Use Case Title
2.33	4.04	Improve assignment of rolling stock
2.31	2.01	Mitigate network disruption through personalised communications
2.27	1.10	Understand use of trip tracking
2.19	1.06	Improve support for passengers with disabilities
2.18	4.02	Improve energy efficiency
2.14	5.05	Data-driven robust timetabling
2.14	5.03	Target messages and advertising to reduce overcrowding due to planned events
2.14	1.02	Real-time train availability
2.01	5.02	Manage demand in response to predicted delays
1.99	5.04	Analysis of multi-modal journeys from origin to destination
1.86	1.01	Accurate journey time prediction
1.77	2.02	Real-time prediction of delays

Regarding the bottom-up use cases, two new use cases have been proposed to exploit the following open data: bike sharing analysis (with Madrid data), and incident analysis (with Network Rail data). Moreover, three new use cases have been proposed:

- Decision Support System for multimodal disruption management;
- Crowd management-based recommendation system;
- Overall train traffic optimization.

For all the bottom-up use cases (in CONNECTIVE) and the Extensive use cases, processing chains combining Descriptive, Predictive and Prescriptive Analytics have been enriched to help transport operators with decision support tools offering results directly operational for them.

New visualization components have been added or enriched: a new visualization framework for the maintenance use case, new visualizations for the two new use cases and the enrichment of the visualizations for the timetable optimization analyses, including virtual reality. Examples are given in the figure below for the maintenance use case.



Besides these visualizations, more operational visualizations have also been developed to be used in a more straightforward way by TSPs. In the figure below, the KPIs computed in the timetable optimization analyses have been integrated into an automatic supervision tool used directly by transport operators.



In all the use cases developed in CONNECTIVE and Extensive, the transport demand analysis is at the core of all the studies. Exchanges and collaboration between the two projects have started regarding the inclusion of transport demand in existing ontologies and standards.

These activities will continue in 2023 and the different processing chains will be integrated in demonstrators and the different visualizations in the Operator Portal.

In 2022, there were no official deliverable foreseen. Business Analytics has been presented at three important transportation events: WCRR 2022, InnoTrans 2022 and TRA 2022.

Work in this TD will continue until mid-2023, supported by the activities of projects CONNECTIVE and EXTENSIVE.

TD4.6 Business Analytics									
2015	2016	2017	2018	2019	2020	2021	2022	2023	...
Finished: IT2RAIL			Ongoing: CONNECTIVE, EXTENSIVE						

TD4.6 reports having accomplished 100% of the planned work up to the end of 2022, which represents approximately 94% of the overall TD objectives.

ITD4.7 Integrated Technical Demonstrator

At the core of the ITD lies the objective of opening the transportation ecosystem to new business actors, able to rejuvenate the transportation ecosystem technologies and business models, thus achieving the goals of European leadership in the market. The ITD will release, on a regular basis and for all TDs, successive versions of enriched deliverables, from early conceptual prototypes to the final version. It will act as the orchestrator of other TDs' developments and will ensure the systems approach to integrate the different TDs' results.

ITD Progress

In 2022, the ITD continued to address the coordination of IP4 activities and support internal technical discussions to guarantee consistency among projects. Another focus from the ITD was the coordination of the interface between the CFM projects and the Open Call projects aiming to have integrated and coherent demonstrations allowing projects' objectives to be fulfilled.

Activities in ITD 4.7 are mainly handled and managed by the project COHESIVE supported by the other CFM projects (CONNECTIVE and Extensive – providing technology development) and by Open Calls (Ride2Rail and IP4MaaS – preparing and running pilots).

The ITD had several targets for the year 2022:

- Improve the performance of the ecosystem, providing a more pleasant experience with the Travel Companion;

- Integrate the initial technical results from the ExtenSive project;
- Integrate the final technical results from the CONNECTIVE project;
- Consolidate the results as the COHESIVE Final release, preparing demonstration scenarios and testing the defined use cases;
- Maintain and coordinate deployments on the two technical environments (test and demonstration) to be used for integration activities, demonstrations, and pilots;
- Demonstrate the COHESIVE Final release at InnoTrans and TRA 2022;
- Step-up the dissemination activities, especially post COVID-19;
- Coordinate the execution of 5 pilots for Ride2Rail and IP4MaaS projects (Athens, Helsinki, Brno, Padua, and Barcelona);
- Plan and prepare pilot activities to be executed in 2023.

At the beginning of the year, most of the activities were focused on improving the ecosystem performance, to allow travellers to have a good experience in the upcoming pilots. The main contributors to this improvement of performance were the restructuring of the Interoperability Framework architecture (CONNECTIVE), as well as some tweaks to the Travel Shopping flow done (ExtenSive). The results are documented in COHESIVE D4.5 and clearly show a better performing ecosystem compared to the previous version and in addition, the newly enabled scalability of the ecosystem allows much higher load. For example, previously the ecosystem could handle 30 concurrent requests, whereas the new version allows 100 and more.

In May 2022, the integration process for the COHESIVE final release started, collecting the results from CONNECTIVE and ExtenSive and deploying them in the COHESIVE integration environment, to be validated and tested for the execution of pilots and demonstrations. These integration and testing phases were done in two stages, the first one focusing on preparing the demonstration environment for the first pilot in July (Athens) with limited functionalities and a second one focusing on preparing the integration environment for the InnoTrans demonstration with all the novelties from ExtenSive:

- Improve existing services offered through the Travel Companion from previous releases, through better performance, user layouts or algorithms;
- Extend the functionalities available on the Travel Companion Web Portal such as, payment via Paypal, E-Wallet, Gmail registration and the capability to purchase Mobility Packages;
- Continue improving passenger/user experience with new mixed reality experiences;
- A new collaborative space where the traveller can see events around them and provide some feedback through comments or media content;
- Dynamic map display allowing to explore the transport network or Points of Interest (POI);
- Addition of individual modes of transport such as the traveller's bike or car on trip results;
- A new supervision tool for Transport Service Providers (TSP) to manage the map content and direct interaction with travellers;
- A new tool for TSPs to manage the events reported by travellers, see statistics and request custom user feedback;
- A new web interface for TSPs to generate digital tickets (QR codes);
- Events detection through vehicle management systems, or drivers' application.

Regarding pilots, only three out of five pilots were run in 2022 because some TSPs have not provided in time the necessary documentation for integration of their services into the IP4 ecosystem. This was for instance the case in Padua, where the delivery of TSP documentation (Trenitalia) planned to be delivered at the end of April, only happened in October. Therefore, the pilot execution was postponed from June 2022 to March 2023. The Barcelona pilot was also postponed to 2023, initially due to the huge risk to have consecutive pilots being executed by the CFM/OC projects, but also due to the late inclusion of a new TSP in the pilot scope (AMTU/Flexitransport). The services of this TSP will only be deployed at the end of January 2023, so all the integration was postponed and the new target date for pilot execution was set for the end of May 2023, allowing a possible use of the Travel Companion during the UITP Global Public Transport Summit (June 2023).

The pilot in Athens was executed in the second week of July, using the following TSPs:

- Attiko metro (Metro)
- OASA (Multimodal PT)

- Taxiway (Taxi)
- Brainbox (Bike-Sharing)
- Crowd-based TSP, developed by Ride2Rail (ridesharing)

The pilot in Helsinki was executed in the first weeks of October, using the following TSPs:

- HSL (Multimodal PT)
- Crowd-based TSP, developed by Ride2Rail (ride-sharing)

The pilot in Brno was executed in the first weeks of November, using the following TSPs:

- KORDIS (Multimodal PT)
- Crowd-based TSP, developed by Ride2Rail (ridesharing)

For all the pilots, the project provided the IP4 integrated technology, language support, user guides, bug fixing and coordination support. Towards the end of 2022, the ITD also focused on the preparation of integration for the pilots running in 2023, as concerns were raised to the Open Call project IP4MaaS as there are still services that were not delivered to the CFM projects, thus putting into jeopardy the integration schedule.

In 2023, the pilots will be running in the following cities:

- Padua, Italy
- Barcelona, Spain
- Athens, Greece
- Warsaw, Poland
- Liberec, Czech Republic
- Osijek, Croatia



New pilot locations (in yellow)

In 2022, two new IP4 Advisory Board Summits were held presenting the progress of the programme and collecting feedback, tackling topics like:

- Challenges and solutions for enabling IP4 ecosystem for multiclient capabilities;
- GDPR policy considerations in IP4;
- Summary on the business study for large scale deployment.

Regarding dissemination of the results, IP4 contributed to a big number of publications and events:

- In June 2022, a paper was presented at the World Congress on Railway Research 2022 (WCRR) in Birmingham and a demonstration was available on Europe's Rail JU stand;
- In June 2022, a pitch and demonstrations were showcased at the Connecting Europe Days 2022 in Lyon;
- In September 2022, IP4 had partners presence on the Europe's Rail JU stand at InnoTrans 2022, promoting some demonstrations of the Travel Companion, TSP tools and Mixed-Reality experiences;
- Participation in the IRP workshop on Integrated ticketing (Air/Rail) in October 2022;
- In November 2022, IP4 had partners presence on the Europe's Rail JU stand at TRA 2022 (Lisbon) promoting some demonstrations of the Travel Companion and Mixed-Reality experiences. In addition, IP4 presented a paper/poster, presented the results to date on the UITP stand and participated in the "Data Sharing as an enabler of Multimodality" (invited session) together with the SESAR JU;
- Presentation of IP4 latest results during the Europe's Rail JU Innovation Days in December.

ITD delivered two major deliverables in 2022: the definition of the demonstration for the Final Release (D5.3) and Route to market (D6.3).

TD4.7 Integrated Technical Demonstrator									
2015	2016	2017	2018	2019	2020	2021	2022	2023	...
Finished: IT2RAIL, SPRINT, Shift2Maas						Ongoing: COHESIVE, IP4MaaS, Extensive			

The ITD reported having accomplished around 99% of the planned work up to the end of 2022, which represents around 80% of the overall TD.

1.2.5. IP5 Technology for Sustainable and Attractive European Rail Freight

The picture below gives a visual perception on where the TDs will introduce improvements.

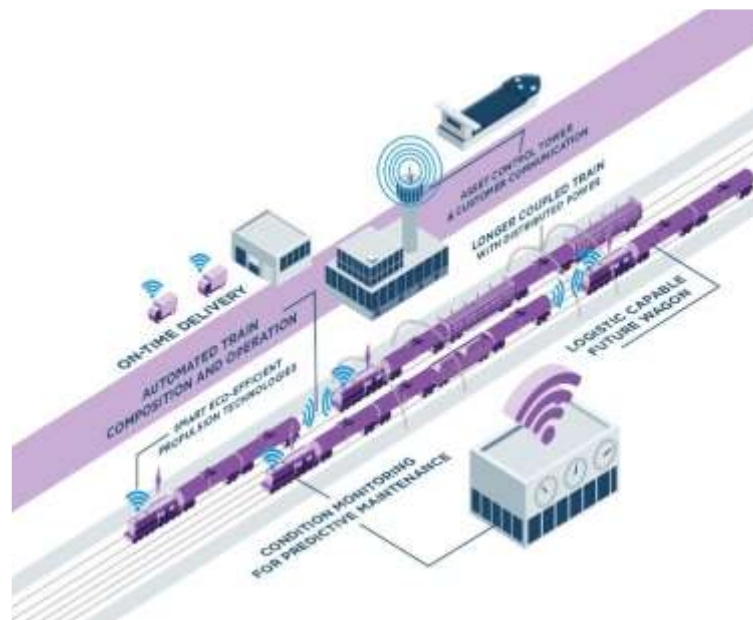

This IP aims to improve the cost competitiveness and the reliability of freight services of the rail sector to meet the ambitious objectives of almost doubling the use of rail freight compared to 2005. This will allow achieving the White Paper objective of a shift of 30% of road freight over 300 km to modes such as rail or waterborne transport by 2030, and more than 50% by 2050. Rail freight must be able to offer a cost-effective, attractive service to shippers that helps to take freight away from the already-congested road network. Work focusses on different market segments with specific technical and operational characteristics and needs.

TD5.1 Fleet Digitalisation and Automation

This TD targets the adoption of two global megatrends for freight rolling stock: Condition Based Maintenance and automation based on DAS/ATO and Digital Automatic Coupling for freight trains. DAC is an important boost in competitiveness of the rail freight market, not only delivering increased capacity in the system, but also enabling digitisation of rail freight, which leads to smart, connected rail freight that offers the necessary information for improved services. The TD focuses on areas such as condition-based and predictive maintenance (CBM) of locomotives and wagons, automatic coupling and freight DAS and ATO, the latter is developed in close collaboration with IP2.

TD progress

This TD progresses through the ongoing work performed in ARCC, FR8RAIL, FR8HUB, FR8RAIL II, FR8RAIL III and FR8RAIL IV as well as the Open Calls, LOCATE and SMART II. These projects build in the initial work carried out in INNOWAG and SMART all completed by 2020.

In the area of CBM, the overall ambition can be summarized as follows:

- Development of a condition-based and predictive maintenance strategy and roadmap, as the umbrella for all asset intelligence projects in IP5;
- System engineering incl. data crunching, modelling, behavioural research & development of mass data infrastructure for live pattern recognition and recommendation of measures;
- Process conceptualization, testing, validation and change management in the implementation.

In 2017, the focus was rather to classify the top components and feedings. Since 2018, the aim was to analyse the data of these components, which is one of the most essential tasks within CBM. The continuous analysis of the data of these components led in 2019 to the first dashboards. In 2020, the CBM did progress significantly by producing and testing a suite of sensors, capturing from actual vehicles key data for vehicle maintenance. In 2021, progress was achieved by testing dashboards against given use cases, with a first draft for the use case “temperature anomaly” is already available to the locomotive engineers.

In 2022, supplementary dashboards for more use cases were developed and finalized. The user can now click through different levels of information. The Fleet Overview shows the entire fleet and provides its general status. One level further, single locomotives can be assessed with the Locomotive Overview. The most detailed levels are the various Component Dashboards, which show individual components and sensor readings. The dashboards were presented and demonstrated at the InnoTrans fair in Berlin in September 2022. The following figures show the overview of a locomotive fleet and a more specific component dashboard.

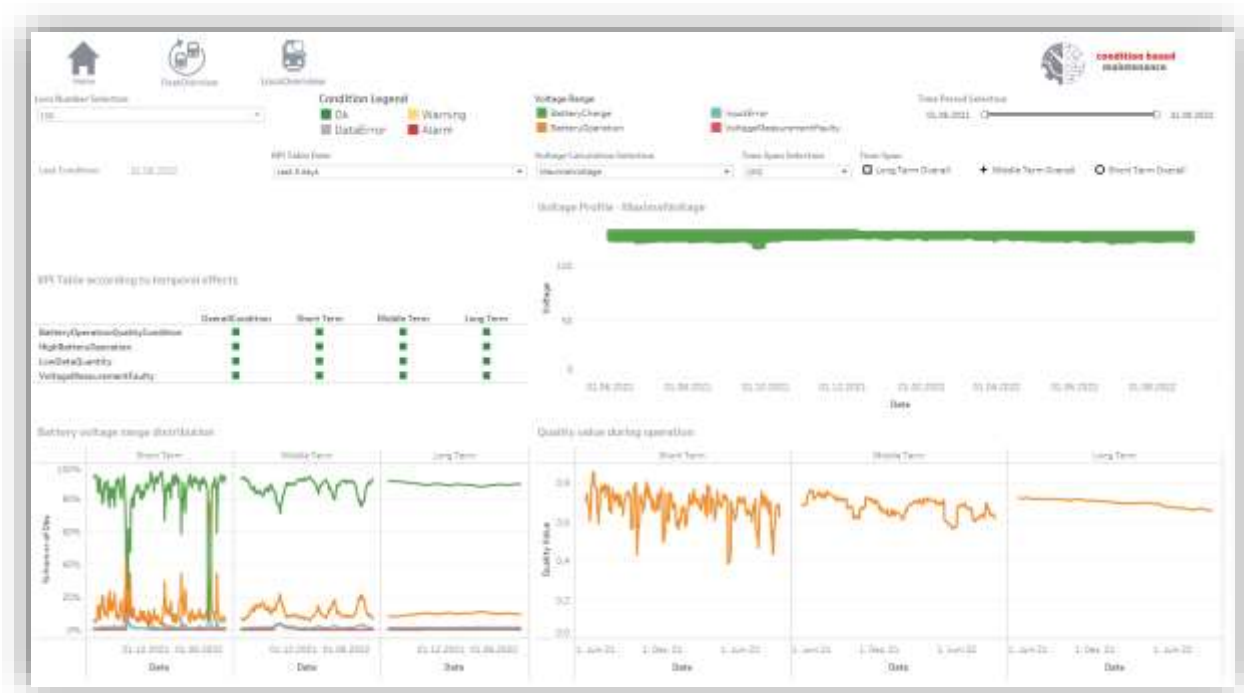

CBM Battery Component Dashboard

In order to improve the quality of the CBM process and to increase trust into the system, a program called Feedback-loop was created. The Feedback-loop provides a link between the maintenance workshops and the data scientists working on the analytics platform. The easy-to-use web interface enables use case managers to filter false alarms from the analytics platform, share advice with the workshop on how to resolve an issue directly, and ask if the issue corresponds to what the use case logic detected. This feedback then helps to refine the use case and check if it is ready for validation.

Furthermore, in 2022, the TD delivered a first version for a tool that will support modularizing maintenance manuals and implementing them to their digital maintenance platform called “DM Cube”. This tool leads to an enormous decrease in complexity within the manufacturing system and provides more flexibility when it comes to updates or new regulations in the maintenance manuals and roll-out to all European entities due to its multilingualism. “DM Cube” brings many advantages: The most important is that it is the essential enabler for performing CBM as maintenance strategy. The modularization enables fast and targeted/flexible updates without the need to completely upload new documents each time. Through the multilingualism, possible implementation across Europe is ensured. The following figure shows the different modules and levels of the DM Cube.

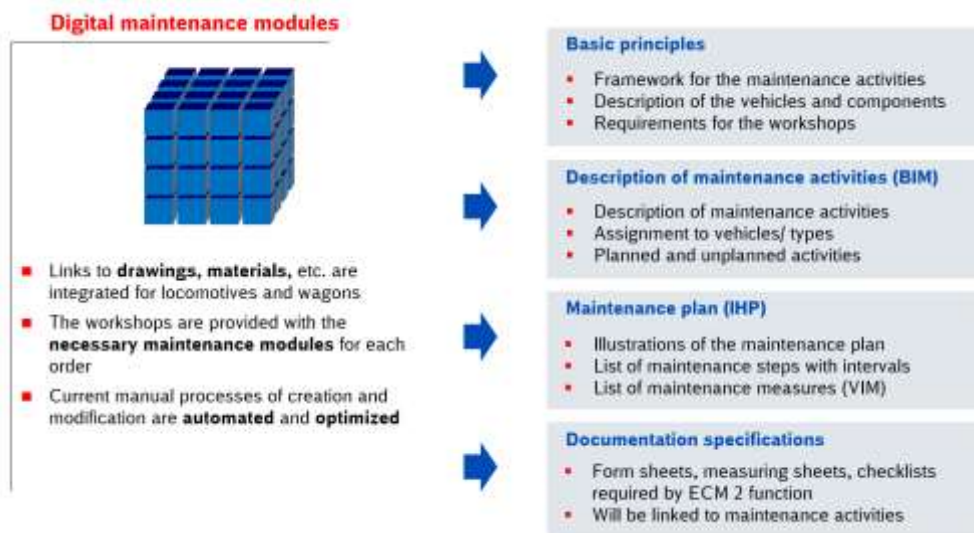

Overview of Digital Maintenance Modules of the DM Cube

The development of the Digital Automatic Coupler made major progress in 2022. In the EDDP (European DAC Delivery Programme), the relevant EU rail freight and industry stakeholders work together in a Joint Sector activity, with the goal of aligning all the DAC initiatives into a single programme, oriented to define a standard solution for DAC and the DAC train functions (automation components) and specifically to prepare the way for future DAC deployment.



DAC Prototypes

The EDDP was supported throughout the entire year 2022 by the DACcelerate project, funded by the Europe's Rail JU. Major steps forwards could be made in EDDP, specifically:

- developing further the DAC mechanical/pneumatical as well as the DAC electrical/ communication specifications, as a contribution to the EDDP WP1;
- laying the basis for the EDDP Board's decision on the DAC energy system (400V, dual phase) and defining further necessary work on the communication system;
- contributing with studies on the workplace conditions under DAC operations and on the DAC environmental/societal impact and line capacity gains;
- laying the grounds for a sound general DAC migration concept for Europe, based on traffic and fleet analysis, for the first time in Europe;
- targeted and broadcast communication and dissemination events, e. g. via a European DAC Day in Prague in October, several webinars on dedicated topics etc.

A first European Investment Plan was contracted by EU-Rail and finalised in early 2023²⁴ by the company EY, setting the basis for further steps for the DAC implementation and deployment strategy. Additionally, a first iteration of the Cost-Benefit Analysis was performed under the leadership of the European Commission, supported by the previous LCC analysis commissioned by EU-Rail.

Together with these developments, the EDDP prepared to transfer its results on technology/specification, testing, authorisation etc. to the linked project stemming from the topic HORIZON-ER-JU-2022-FA5-01 call

²⁴ <https://rail-research.europa.eu/publications/european-dac-investment-plan/>

(EU-RAIL FP5-TRANS4M-R project). One of the major early achievements of this project, in cooperation with the EDDP, was the first consolidated approach on harmonised DAC target operational procedures for train shunting & preparation etc., serving as the unified basis for the further EU-RAIL FP5 technology development.

At the same time, the coordination activity between the EDDP and the EU Rail Innovation Pillar (FP5) and EU-RAIL System Pillar (task 4) was launched. This was supported by the (re)definition and board's decisions on the revised EDDP structure as of 2023 ("EDDP neo"), which will focus on the preparation of DAC migration and deployment, and on the related interaction processes between all three bodies, so that a strong working structure within EU-Rail, from technology development to deployment preparation until embedding of the works in the overall railway system (architecture) could be created.

The third main topic within TD5.1 is DAS and ATO. After the successful ATO tests in Switzerland in 2021 within the ARCC project, the main work in 2022 was carried out within the framework of FR8RAIL IV and builds up on the results of former projects.

A strategic analysis for the roadmap of freight automation was conducted and successfully finalized. The results show how a successful transition from today's manual driving of traction units in rail freight transport to automated driving can be achieved within the next ten years. It includes various recommendations for potential migration strategies and further developments within the rail freight area. The migration should be carried out step-by-step from manual driving to assisted driving with C-DAS (Connected Driver Advisory Systems) to automated driving with ATO over ETCS. A standardisation of functionalities, connectivity and interfaces is required to overcome the hurdle of individual systems.

A new Collision Avoidance System (CAS) for shunting locomotives was created, implemented, and tested in Germany. The tests were conducted in three different Shunting yards performing several static and dynamic use cases. The following figure shows the GUI developed to visualize the CAS behaviour.

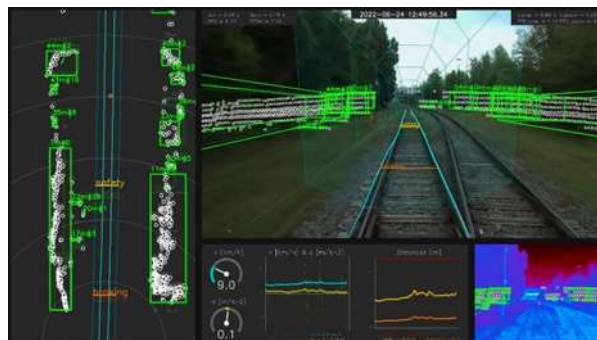

GUI visualizing the CAS system (top-right: camera image, left: abstracted top view, bottom-center: overview dashboard, bottom-right: infrared camera)

The results were used to determine the most cost-effective sensor combination. Recommendations for improvement and future development of CAS were made e.g., implementing Machine Learning in the algorithms for better track detection and realisation of an automated emergency brake. The functional requirements developed are suitable for shunting areas without Automatic Train Protection (ATP) and can also support shunting operations by reducing the impact of human errors in the operation.

To summarise and consolidate all of Freight ATO related work in Shift2Rail (among others ARCC, X2Rail, etc.) a generic freight automation on-board reference architecture was developed. As many automation processes are currently taking place in the European railway sector, there is a great need for harmonisation and synchronisation of the different systems. The developed open and "generic" architecture fulfils this requirement and is more cost-effective compared to vendor-specific architecture. These results also provide an important foundation for all follow-up activities in the field of ATO within Europe's Rail in the Flagship Projects 2 and 5 (FP2-R2DATO and FP5-TRANS4M-R) and the System Pillar.

TD5.1 Fleet Digitalisation and Automation										
2015	2016	2017	2018	2019	2020	2021	2022	2023	...	
	Finished: SMART 1+2, FR8RAIL, INNOWAG, ARCC, FR8RAIL II, LOCATE									
		Ongoing: FR8RAIL III, FR8RAIL IV								

2022 has been a successful year for the TD as working speed took up again after the impacts from the COVID-19 pandemic. Condition based maintenance made great progress and two field tests in Minden, Germany could be conducted.

As per 2022, 10 out of 18 deliverables were delivered. TD5.1 has reported having accomplished 93% of the planned work up for the period, which represents around 90% of the overall TD.

Next steps in 2023 will be the end-to-end demonstrator for CBM. The other topics such as ATO and DAC are being continued within the framework of the corresponding Europe's Rail Flagship Projects.

TD5.2 Digital Transport management

This TD is targeting the digitisation of processes to optimise service planning and operation thanks to real-time data gathering, steering, operation, and coordination of intermodal transport at higher speed. This supports better utilisation of available capacity, by optimising access and operation of local hubs which are essential but cost-intensive subsystems for rail freight business. The TD is looking into improvement of effectiveness in marshalling yards and terminals with the introduction of innovations in real time information management (e.g., intelligent video gate). The key challenge is to improve the interaction between yards/terminals and the network, thus reducing the lack of information and adding new decision tools that will increase punctuality and capacity.

TD progress

This TD is currently progressing through the ongoing work performed in FR8RAIL II, FR8RAIL III and FR8RAIL IV. These projects build on the initial work carried out in INNOWAG, SMART, ARCC, FR8RAIL and FR8HUB, all closed by 2021.

The TD 5.2 is built around the following building blocks:

- Intelligent Video Gate Terminals;
- Improved methods for timetable planning & Real Time management;
- Real-time yard management & SWL system.

In 2022, most of the efforts within the IVG stream did focus on the enhancement of the algorithms in order to recognize more different types of wagons and more intermodal unit numbers. The SW has undergone a testing campaign that enabled releasing an improved version.



IVGs in Göteborg, Sweden and Nuremberg, Germany

The hit rate (successful acknowledgement) of the readings differs between sort of the interface i.e., ADR signs or ILU numbers. New findings and challenges are constantly faced with issues such as hinterland markings which are not standardised and thus hardly recognized. Apart from logistics, damages and graffiti

(see the following figure) recognition. The challenge has been to train algorithms with loads of images so knowledge base was built upon.

Intelligent video gates – by digital identification of the wagon and load unit – did help to optimize the terminal process with better data exchange and interoperability, consequently connecting to the network management in a more efficient way. For example, by reducing the dwell time in terminals and design optimization for future terminals.



Example of processed image with graffiti

The recognition of wagons through IVGs enables different use cases of which the following were closer examined in 2022:

- Information to customers;
- Planning;
- Damages;
- Dangerous goods;
- IVG at Yards;

The use cases are described in more detail in the final deliverable and the project ended in 2022.



Example of processed image with dangerous goods.

The 2022 TD's goal for improved methods for timetable planning & Real time Management Terminal and Yards was to move ahead on the development of the solutions identified for reducing the gap between planning and operation and developing methods for improving network management.

Progress continues by increasing TRL for the advanced real time network management for freight rail traffic. The focus has been on the coordination between traffic control, train drivers and yard management, three essential parts in the real time management of a rail freight network. Works on the final demonstrator started within FR8Rail III compiling scenarios for enhanced and integrated line- and yard planning. The proposed demonstrator had a focus on the interaction between different systems and between humans using these systems, but also on the rail freight system perspective by the inclusion of the connection between the line and the yard. The main demonstrator exhibits interaction freight node (yards) and the network. The Yard Coordination System demonstrator (YCS) was developed within FR8HUB and FR8Rail III.

Demonstrator YCS co-operative Planning Malmö Yard

The main result of this activity is the demonstrator and the specifications of the integrated demonstration platform for planning at a marshalling yard (see the concept in the following figure). The specified and developed tool assists in producing coordinated plans for a combined arrival/departure yard. The actors and their roles are specified together with the shared data and the owner of different data. The conflicts

that the tool detects, and highlights are described as well as the calculation principles for default values which reduce the workload of the users.

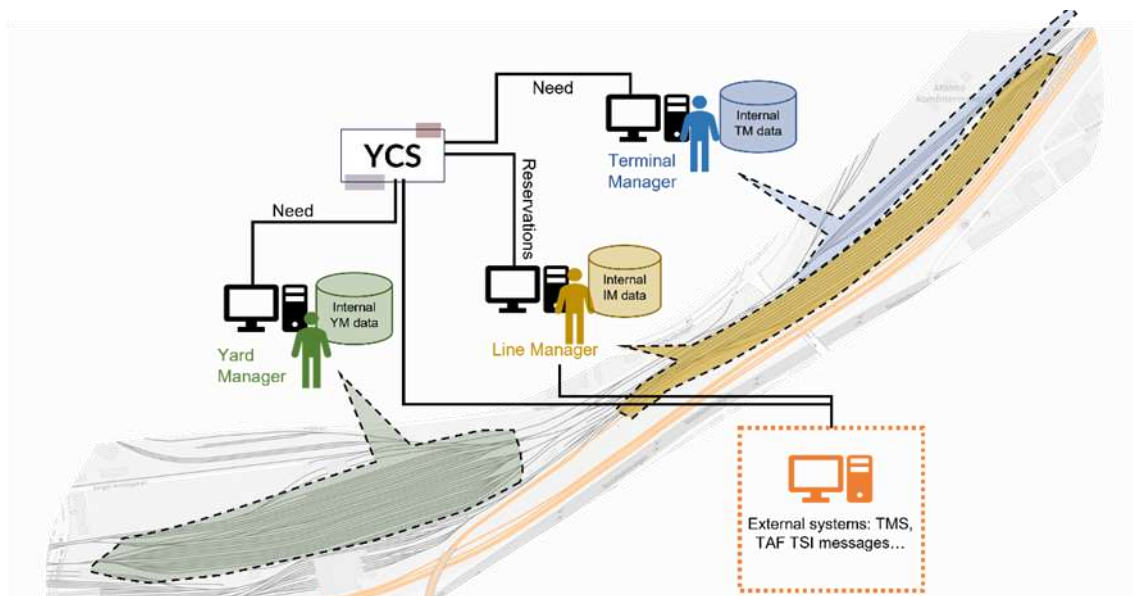

Yard Coordination System Concept at Malmö

YCS connects Malmö yards to the network. Line manager controls arrival/departure yard. This yard is connected to marshalling Yard manager, combi Terminal manager and the rail network.

Demonstrator for improved forecasts Malmö – Hallsberg, Estimated Time of Arrival

Further, a model framework for connecting yards and lines is proposed. This model framework incorporates a yard departure prediction model based on machine learning and a rail network macro-simulation model, Proton. The aim is to create a transparent interconnection between yards along the network lines, which will give both the infrastructure manager and the yard operator improved action flexibility by giving them higher prediction accuracy for arrivals and departures.

The demonstrator integrates Planning Module M2 from Timo SW and the macro simulation SW Proton. Scenarios take as a reference Hallsberg – Malmö rail traffic taking into account planned and unplanned traffic disruptions due to infrastructure maintenance work and infrastructure errors. Progress has been achieved as simulation/rendering times have gone down from hours to the order of magnitude of minutes, becoming closer to expected TRLs regarding response time for a commercial use of this kind of tool.

TD5.2 Digital Transport Management										
2015	2016	2017	2018	2019	2020	2021	2022	2023	...	
		Finished: SMART, ARCC, FR8HUB, OPTIYARD, FR8RAIL II								
			Ongoing: FR8RAIL III							

In 2022, all IVG topics could be concluded with the of IVGs in Sweden and Germany and the submission of all corresponding deliverables and the demonstrator (D3.2 and D3.3). The yard management topics made great progress as well and the described Demonstrator for a Yard Coordination System was successfully tested and evaluated.

As per 2022, 3 deliverables out of 4 were delivered. TD5.2 has reported having accomplished 95% of the planned work up to the end of 2022, which represents around 95% of the overall TD.

TD5.3 Smart freight wagon concepts

This TD has the objective of delivering technical demonstrations of next generation running gear and wagons for freight. The next generation freight wagons will improve the competitiveness of rail freight logistics by providing more flexible and reliable high-capacity assets at competitive costs. This will be

achieved by means of the technological outputs delivered by this TD consisting of low-noise, lightweight, high speed & track friendly freight running gear, intelligent freight wagon for core market share increase & extended markets able to provide information such as wagon assets status and location.

TD progress

This TD is currently progressing through the ongoing work performed in FR8RAIL II, FR8RAIL III and FR8RAIL IV. These projects build in the initial work carried out in FR8RAIL, INNOWAG, FR8HUB all closed before 2022.

The TD5.3 is built around the following building blocks:

- Running gear and Core Market Wagon (CMW);
- Extended Market Wagon (EMW);
- Telematics and Electrification.

In 2022 the work related to Core Market Wagon (CMW) has been focused on:

1. bogies and CMW,
2. Alu-bogie frame
3. Telematics

CMW redesign and testing

For the CMW, laboratory test in Cerhenice have been carried out and moreover, the CMW was operated along its own axis in two real operational environments on the track Poprad (SVK) – Cerhenice (CZE) and back, and on the track Poprad (SVK) – Berlin (GER) and back.

As the CMW wagon was already built in the previous stages of the project, part of the work in 2022 was related to the modification of the brake mode. The originally designed brake was in the S mode – mechanical lever brake. It was necessary to completely redesign the brake, to design it and to physically reconstruct it for the SS mode and to change it to a disc brake.

For the testing, two completely new bogie prototypes were manufactured. 4 wheelsets for the CMW were delivered and assembled into 2 new bogies for CMW testing and exhibition. These wheelsets equip brake discs and noise absorption rings, for noise mitigation. Further, the required activities to produce 2 new FR8RAIL bogies have been covered in 2022.



FR8RAIL bogie

Scheduled and performed tests were proposed with an aim to verify the interfaces of the wagon, equipped with the bogies FR8RAIL regarding operational safety on a public track and to identify wagon utility potential for operation at 140 km/h speed. The following tests were performed:

- Verification of safety against derailment on twisted track according to EN 14363. The safety against derailment test was performed in accordance with the applicable standards, and the measured values of the wagon were under the limit values. The wagon passed the test;
- Verification of brake performance according to UIC 544-1: All specified and achieved values correspond with the required theoretic values specified in the brake calculation;
- Running tests according to EN 14 363: Results of the comparison Y25 vs. FR8RAIL meet the simulation assumptions, according to which the bogie FR8RAIL achieves more favourable values of monitored values during curve negotiation than a standard Y25 bogie. This significant improvement then leads to reduction of wheel and rail infrastructure wear. At the test speed of 154km/h, the CMW with the bogies FR8RAIL is stable and it achieves transverse acceleration values that are significantly under the limit values.

The Alu bogie mock-up was sent to InnoTrans 2022 and successfully presented with positive feedback.



Setting of the measuring wheel for the track tests (left). Train set during the test on the VZO (right).

- Noise measurement of running wagon according to TSI NOISE: Measured noise levels during wagon passing, after converting to 80km/hour, meet the limit according to TSI NOI, i.e. $L_{pAeq,Tp}(80 \text{ km/h}) \leq 83 \text{ dB(A)}$.
- U-frame fatigue test: No permanent deformations, cracks or outer damage were discovered on the test sample after 8 mil. cycles. Loosening of the bolted joints did not occur. A bolt was broken after 8,300,000 cycles. Because of these reasons, the design was assessed as suitable.
- After testing of CMW with FR8RAIL bogie, we analyse the details of the results. The redesign and modification after testing of the CMW/FR8RAIL bogie are ongoing.

Alu-bogie-frame

Apart from the innovative bogie in the CMW prototype, that has been successfully integrated in the wagon and will form part of the wagon demonstrator, TD5.3.1 will explore even more weight reduced bogies, this time not with the objective of final integration in the CMW demonstrator. This bogie will use advanced welding and special structure design that aims to further reduce the weight of the bogie thus improving potential future wagon payload.

Regarding the new aluminium bogie, the Alu-bogie-frame was produced in 2021, but the completion of a functional mock-up with brake, and wheelsets. Was done in 2022. After the final surface treatment, the Alu-bogie mock-up was sent to InnoTrans 2022.

In the aim to improve the technical characteristics of the Alu-bogie-frame, an optimization of material for the longitudinal and crossbeam was made. Several destructive and non-destructive tests and analyses of the results were done on samples from different aluminium admixtures.

In 2022, the modification and optimization of the structure from the point of view of strength are underway. It will continue partially also in Q1 2023. Since the displayed fortress mock-up is weak from the point of view of castings, we are dealing with new higher-quality castings and the construction of new prototypes. The plan for 2023 includes some laboratory tests with the new Alu-bogie and operational field tests with selected wagons.

Telematics

Furthermore, in 2022, the Tatravagónka Core Market Wagon was equipped with a WaggonTracker, the Data.Beam and an humidity sensor for axle bearing (HSAB), evolved and developed in the FR8RAIL project. In 2022, the CMW served as an important enabler to showcase and test the latest monitoring and digital systems for fleet and operations optimisation and as mentioned before, was exhibited very successfully at this year's InnoTrans in Berlin. The wagon was equipped with a system fulfilling a minimum of TRL 5, (higher TRL will be reached after field testing which is planned to happen in 2023) realizing the concept of intelligent, modern freight wagons demonstrated in operational railway environments. The On Board telematics included WaggonTracker ADV being one of the first freight systems worldwide, that fulfils comprehensive monitoring functions and automates complex manual processes. The WaggonTracker system is further enabled with the integration with the Data.Beam and HSAB sensor for advanced vehicle components and running-behaviour monitoring. Final operational tests of the core market wagon (TRL7) are expected to happen in Slovakia during 2023.



Core Market Wagon at InnoTrans 2022 including T&E Equipment, ProDisc Axle, SiSet Silet Wheelset, and an Automatic Coupler

A special challenge in 2022 was the InnoTrans exhibition in Berlin. The CMW was equipped with DAC and with telematics. Both demonstrators CMW and Alu-bogie were presented during InnoTrans 2022 in Berlin.

Detailed development of EMW

The wagon chassis saw more significant changes on the path from concept design to final physical implementation. The wagon was modified from its conceptual design with bent square tubing in the solebars to a sheet-metal-based design with topology-optimized light weighting cut-outs and torsional compliance. The design of the wagon frame weldment uses conventional materials such as S355 J2 but optimizes the contours of the structure, material thicknesses and weight-reduction cut-outs in order to arrive at a minimal mass. Sheet metal forms the bulk of the structure, with machined parts incorporated at specific locations, for instance to accept the air springs and running gear linkages. Similarly, the design process for the bogies was completed in early 2022, resulting in the detailed design shown below in the figure.

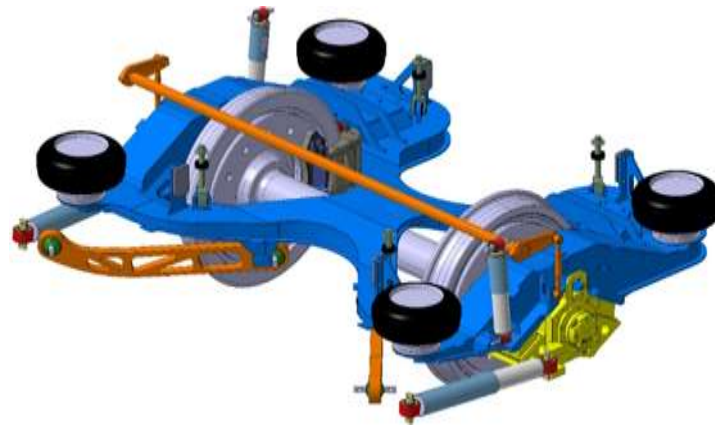

Finished single-wheelset bogie design for the EMW. The bogie frame in blue connects all components and transfers forces to the two orange traction rods (lower left), which converge toward the centre of the bogie, forming a virtual pivot point.

Wheelset design and production Automatic Corner Lockings development and prototyping

Two dedicated wheelsets have been produced for the EMW, with the following skills:

- Wheel-mounted brake discs to reduce the damage on the wheel tread and to minimize the rolling noise.
- Lightweight axle body (5-10 % less than classic axlebodies), for noise mitigation and to reduce energy consumption.
- Hollow axle enhance the ultrasonic crack probability of detection, increasing safety and reducing the number of inspections.
- Higher resistance axle steel grade.

These wheelsets have been TSI certified by a NoBo and provided with a CE certification for free operation in the EU network.

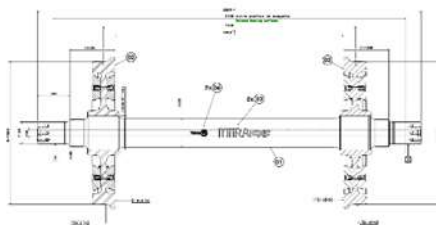

EMW Wheelset

At InnoTrans, the EMW was displayed along with a billboard explaining the operational concept of the wagon and its various functions.



EMW at InnoTrans 2022

Currently, work is ongoing in preparation for a series of tests aimed at examining the function and behaviour of the wagon on real tracks. These tests are also meant to serve as the basis for a potential validation of the multi-body-simulation results, allowing more well-founded analyses of operating regimes not examined in the course of the planned tests. The TD has also progressed in the activities related to telematics and electrification with the aim of building up the intelligent freight wagon. During 2022, activities related to the development and integration of the subsystems, definition of the integration of Telematics and Electrification on the Wagon and field tests have been covered. Furthermore, the functionalities and sub-systems were integrated in the demonstrator shown at the InnoTrans 2022.

The effort on the Telematics and Electrifications has mainly been in the successful development of a 3rd version of the power harvester which was showcased at InnoTrans together with the freight train wireless communication networks, wOBUs. The prototype was successfully tested during field tests carried out at Minden (Germany) in November 2022.



Axle Mounted Power harvester in the laboratory test-bench and installed in a wheelset for field tests in Minden

As per 2022, 6 deliverables out of 7 expected were delivered. TD 5.3 has reported having accomplished 93% of the planned work up for the period, which represents around 85% of the overall TD.

TD5.3 Smart Freight Wagon Concepts									
2015	2016	2017	2018	2019	2020	2021	2022	2023	...
							Finished: FR8HUB, INNOWAG, FR8RAIL, FR8RAIL II		
							Ongoing: FR8RAIL III, FR8RAIL IV		

TD5.4 New freight propulsion concepts

The target of this TD is to provide more attractive rail freight services to the final customer, with competitive rail solutions maximizing flexibility and efficiency while reducing the operating and maintenance costs. The focus of this TD is on improving the overall performance of today's locomotives by adding and integrating additional functionalities and technologies. Future locomotives will provide extreme flexibility for operation in non-electrified and in electrified lines, allowing private and public operators to offer broader rail freight services according to demand without the need of changing the locomotive or allowing the new production

concepts. Future locomotives will feature remote control for distributed power, thus, allowing the increase of the train length up to 1500m and consequently improving the cost efficiency of rail transport. Moreover, other areas of work include reduced LCC, braking energy recuperation, operational efficiency increase by automating various activities such as train start-up, train preparation, start of mission, stabling and parking, generally shunting.

TD progress

The main achievements for 2022 were (1) the progress in the development of the last mile battery in lab environment (2) advances in the design of traction batteries including the battery management system for the hybridization of freight locomotives, (3) new concepts for the auxiliary converters and (4) the specification for the integration of the DAC in TRAXX locomotives.

In the area of last mile battery, the TD has continued and finalized the development of the 800V water tempered battery. The battery cubicle, ready to be installed on a TRAXX locomotive, has been built and integrated into a container. With this setup, the battery and the innovative DC/DC converter were tested using real load cycles provided by real use cases. The results were described in the deliverables D6.1 & 6.4.



Battery cubicle (left side) consisting of battery blocks (right side), thermal conditioning unit, battery management system and DC/DC converter

The full system with 212kWh will, depending on how the battery blocks are connected, provide enough power (in the range of several hundred kW) to pull heavy freight trains on their last mile.

In the area of traction battery development an investigation on utilization of the automotive qualified Li-Ion cells for traction ESU (energy storage units) in the railroad applications was performed, ESU architecture concept was investigated, lab-scale ESU demonstrator was built, and the feasibility of the investigated solution was validated.

Beside the standards and norms, an insight into the basic requirements for the railroad traction application was investigated. Here the investigation mainly focusses on the outcomes of the FR8Rail HUB Project, where potentials for fuel savings were investigated when replacing the diesel generators with Li-Ion traction batteries in the locomotives.

Further, the frames for a railroad ESU concept were investigated. Proposed modular and scalable architecture of a locomotive ESU providing sufficient energy content and power capability while fitting into available space is illustrated in the figure below.

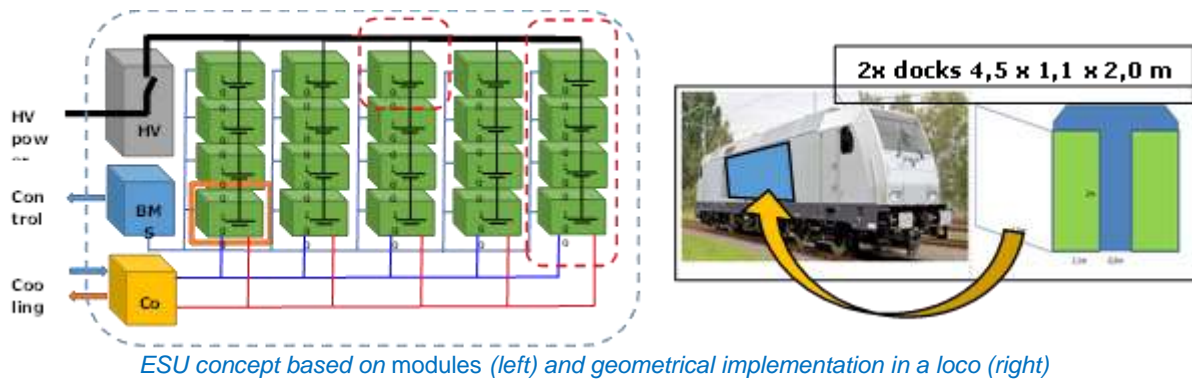

A lab-scale demonstrator for the proposed solution was prepared. The limitations that popped up during the compilation of the ESU lab-scale demonstrator were described, and the solutions introduced based on the recent experiences in the development of the automotive traction batteries were elaborated.

The demonstrator was used to perform basic functional tests validating that automotive qualified Li-Ion cells, that could successfully cover the needs of railroad traction battery systems and could be a good candidate for the railroad traction battery applications.

Following the detailed investigations in 2021 for the study of “Improved Auxiliary Network”, the deliverable “Study of improved auxiliary networks for locomotives considering MF and SiC technologies” was finalized and submitted. The study revealed that substantial improvements in system weight (up to -52%), volume (up to -64%), efficiency (up to +16%) and energy savings could be achieved using MF technology and SiC semiconductors. However, the total cost of ownership could not be amortized in a reasonable timeframe for the considered energy costs and SiC semiconductor prices.

Further, the report on highly efficient system design with increased dv/dt and SiI has been finalized, revealing that the usage of SiC brings substantial improvement in traction converter weight (up to -12.5%), volume (up to -12.5%) and efficiency (up to -70%). With an improved traction design with SiC, the net energy consumption of the locomotive could be reduced by 2%. By the end of 2022, all component orders required for the small-scale demonstrator have been placed. With the demonstrator the practical validation of the theoretical results from the report mentioned above shall be performed.

In the area of long trains, the technical concept and requirements for the additional functions were finalized. The work is used as the base for Europe's Rail FP5 providing the functional specification for long train operation for the digital freight train.

In the area of the digital automatic coupler and based on the specification prepared in the EDDP expert group, a detailed analyses of the integration of a central coupler in the TRAXX locomotive platform has been performed. The document collects the electrical, mechanical and pneumatics requirements for the integration and is in its final release process.

In 2022, 4 deliverables out 5 expected were delivered. TD 5.4 has reported having accomplished 90% of the planned work up for the period, which represents around 89% of the overall TD.

Pending work (e.g. small-scale demonstrator for SiC-Converter) will be carried out in 2023 in order to finalize the Technical Demonstrator.

TD5.4 New Freight Propulsion Concepts										
2015	2016	2017	2018	2019	2020	2021	2022	2023	...	
	Finished: FFL4E, DYNAPREIGHT, FR8HUB, M20, FR8RAIL, FR8RAIL II									
			Ongoing: FR8RAIL III, FR8RAIL IV							

TD5.5 Business analytics and implementation strategies

This TD reached its completion already in 2021.

1.2.6. CCA Cross Cutting Activities

An overview of the various work areas in the CCAs is shown in the figure below.



Cross Cutting Activities are relevant to the different subsystems of the five IPs taking into account the interactions between them.

These Cross Cutting Activities ensure that the R&I activities within the different Innovation Programmes are closely aligned in terms of their objectives and their requirements, as well as the methodologies for evaluation and assessment of impacts. The Cross Cutting Activities facilitate a coordinated approach in order to avoid duplication and guarantee consistency.

CCA work is organised so as to achieve the objectives in the following areas:

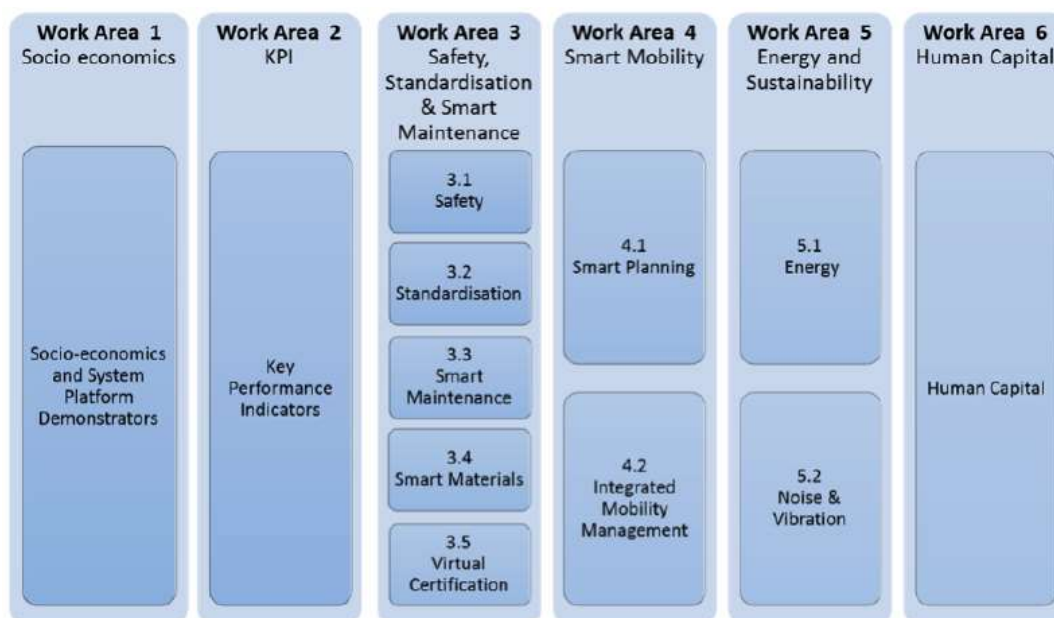

Activities under WA 3.4 (Smart Materials) have not started; some activities on this subject will be carried out in the dedicated Innovation Programmes. Activities in the following WA have been accomplished in previous years: WA 3.1 (Safety), WA 3.3 (Smart Maintenance), WA 3.5 (Virtual Certification), WA 4.1 (Smart Planning) and WA 6 (Human Capital). Below a summary of the activities performed in the CCA Work Areas (WA) in 2022. In 2023, the remaining active work area will be focused on WA 5.2 (Noise and Vibration).

For IP2 (Command, Control and Signalling), a different modelling approach compared to the other subsystems (such as vehicles and infrastructure) was developed and reviewed in previous years. The values from the review and update in 2021 were confirmed during the annual update of 2022.

For IP3 (Infrastructure), an in-depth KPI model review was conducted during a workshop in November 2021 leading to a confirmation and validation of the KPI model calculation. During the 2022 improvement collection, no differing values were reported.

As part of the review process for IP5, the differing effects of three different sub-types of freight trains were analysed and the KPI model was adjusted accordingly. As a result, the LCC values were improved and especially the KPI capacity was increasing.

The final release of the Customer Experience model reflecting the impact of IP4 (Passenger Information) was published in 2022.

WA2 KPI method and integrated assessment								
2015	2016	2017	2018	2019	2020	2021	2022	...
Finished: Roll2Rail, IMPACT-1					Ongoing: Tender KPIs, IMPACT-2			

In 2022, one deliverable was planned and has been submitted. WA2 has reported having accomplished 100% of the planned work up to the end of 2022. The WA is completed.

WA3 - Safety, Standardisation and Smart Maintenance

Work Area 3 builds on the activities of the projects Plasa/Plasa 2, GoSAFE RAIL, IMPACT2 and SMaRTE. The graph below refers to all the activities performed in the WA. WA 3.4 (Smart Materials) has not been launched in the S2R Programme. The activities in Safety (WA3.1), Smart Maintenance (WA3.3) and Virtual certification (WA3.5) were completed in previous years. Only one work area remains active: Standardisation.

WA3 Safety, Standardisation, Maintenance, Materials, Virtual Certification								
2015	2016	2017	2018	2019	2020	2021	2022	...
Finished: PLASA, GoSAFE RAIL, SMaRTE, PLASA-2						Ongoing: IMPACT-2		

WA3.2 – Standardisation

The main objective of WA 3.2 is to foster the transfer of S2R results and outcomes of innovation activities into standards or regulatory documents when needed and beneficial. It aims to provide a coordinated approach across the S2R research activities and to develop optimised pre-standardisation aligned processes with the relevant standardisation bodies, standard setting organisations, as well as ERA.

The Standardisation work area is covered in the IMPACT-2 CFM project, which started in September 2017.

The final revision of the Standardisation Rolling Development Plan (SRDP) was carried out in 2022. Updates on standardisation potential of the S2R outcomes continued across the different TDs and are reported in version 5 of the SRDP, to be published early 2023. Exchanges with the European Commission, CEN and CENELEC railway Technical Committees and ERA contributed to inform the standardisation and regulatory bodies about the possible standardisation proposals and their feedback were captured in the SRDP.

Work on detailing and contextualising the standardisation needs and proposals, aiming at describing how the S2R contributions to standardisation meet the sector's needs and engagement in standardisation continued in 2022. It is focusing on a selection of topics of major importance for the sector and for their support to European Regulation. The document (D5-2 - Detailed Standardisation Roadmap) addresses the following key areas: TCMS, DAC, noise, Virtual Validation, Conceptual Data Model and Smart Power Supply.

All deliverables were submitted in 2022. WA 3.3 has reported having accomplished 100% of the planned work up to the end of 2022. The current work represents 100% of the overall WA. The WA is completed.

WA4 - SMART MOBILITY

Work Area 4 initially builds on the results of the Roll2Rail. The Smart Planning (WA4.1) activities were covered in the projects Plasa, GoSAFE RAIL and Plasa-2. The work was concluded in 2021. Activities related to Integrated Mobility Management (I2M) work area are covered in IMPACT-2 and FINE 2. The activities on I2M in IMPACT-2 were concluded in 2021. The activities in FINE-2 are still ongoing.

WA4 Smart Planning, I2M								
2015	2016	2017	2018	2019	2020	2021	2022	...
Finished: IN2Rail, PLASA, GoSAFE RAIL, PLASA-2, IMPACT-2						Ongoing: FINE-2		

WA4.2 – Integrated Mobility Management

WA4.2 aims to integrate the data exchange between Traffic Management Systems, Freight operations and Asset Management Services using a unified data exchange mechanism (the “Integration Layer” or IL) to develop new business service applications.

The overall results of WA4.2 represent a significant step towards improving the freight and passenger rail related Traffic Management operations both in terms of planning, execution and supporting tools.

In a first step, IMPACT-2 delivered in 2021 specifications, use-cases, processes, data structures and demonstrators for rail freight related operations. The final works of WA4.2 carried out in 2022 in FINE 2 built on the achieved results specifying and developing complementary business functions for rail freight operation, tools and Interfaces for the integrated communication infrastructure both for Freight and Passenger transportation.

The Demonstrators developed, tested and validated in 2022 were:

- Application Programming Interfaces for Freight Management Systems (TRL3/4): integrating with TMS with the aim to provide freight users with calculated and published Estimated Time of Arrival (ETA) information in order to fulfil intermodal transport information requirements;
- Application Programming Interfaces for a conflict management application (TRL3/4) integrating with TMS. Conflict detection and the resolution proposals are managed via the Integration Layer. The interface to a sandbox service enables for the first time concurrent working of several operators on one traffic solution as well as merging independent proposals into a traffic plan solution;
- Prototype for the application “dangerous goods management” (TRL3/4) was developed that receives from the on-board system the configuration data diagnostic information such as, state of wagon, current wagon positions and alarms (asynchronous) etc, improving the effectiveness and reducing the cost of condition-based maintenance, enhancing the level of safety of trains carrying dangerous goods and providing real time localization of the freights wagon fleet while improving logistic management.

Pre-defined use cases and interface specifications were expanded, and a final series of 3 Initial proofs-of-concept supporting the analysis of traffic situations to improve Traffic Management looking at the following areas were developed in 2022:

- Delay propagation (TRL5): this functionality improves forecasting and reporting of the impacts of a train’s delay during its journey; applied to and tested using the UK live system – DARWIN.
- Possession Planning (TRL3/4): this application improves the assessment of the work that can be conducted during a period of maintenance by automatically scheduling activities and defining the optimum approach. This can help better schedule works vs manually.
- Bus Pinch-Point Analysis (TRL5): this tool enables the analysis of interfaces with the bus network to understand how they may be providing risks helping to identify possible economic impact to customers of missing their service or generating station overcrowding.

In 2022, three deliverables were planned and all have been submitted. WA 4.2 has reported having accomplished 100% of the planned work up to the end of 2022. The current work represents 100% of the overall WA. The WA is completed.

WA5 - Energy and Sustainability

Work Area 5 builds on the initial results of the ROLL2RAIL. Relevant activities were completed in the projects FINE 1, OPEUS and DESTINATE. Activities in these areas are ongoing in the projects FINE-2, TRANSIT and SILVARSTAR.

WA5 Energy and sustainability								
2015	2016	2017	2018	2019	2020	2021	2022	...
Finished: Roll2Rail, DESTINATE, FINE 1, OPEUS					Ongoing: FINE-2, TRANSIT, SILVARSTAR			

WA5.1 – Energy

The overall objective of this work area is to develop a standardised methodology for estimation of energy consumption by simulation and measurement enabling the standardised specification of energy efficient railway systems.

The Energy work area is covered in one ongoing member's project FINE-2, launched in December 2019.

After suffering some delays, this Work-area caught up and managed to complete all activities by end of 2022.

To assess the overall contributions of the S2R innovation to energy reduction, the energy baseline for the four theoretical system platform demonstrators (high speed, regional, urban (metro and tram), freight) were defined. From the technology readiness level, the energy savings can be achieved in short term, with refurbishment or in long term, with development of new rolling stock. Total energy savings due to S2R innovations was reported in FINE-2²⁵ D2.2:

	Total energy saving for traffic segment / SPD				
	SPD1 High speed	SPD2 Regional	SPD3 Metro/ Tram	SPD4 Freight Single wagon	SPD4 Freight Intermodal
Short term (refurbishment)	0,5 %	15 %	8 %	4 %	21 %
Long term	9 %	19 %	11 %	4 %	33 %

Further assessment was carried out and an outlook on future innovations on energy-saving technologies for rail was identified. Some of these technologies are covered in the EU-Rail programme and some could be considered still for further research.

The following energy saving topics are foreseen in EU Rail flagship projects (FP) to achieve a higher TRL. The energy saving potential should be estimated by means on demonstrators in real operation:

- Automatic train operation with energy-optimised driving (FP1, FP2 and FP6)
- Traffic Management System allowing smoother traffic and less unplanned stops (FP1 & FP6)
- Substitution of diesel trains by battery and hydrogen powered trains (FP4 and FP6)
- Airless train with airless brakes, suspension, pantograph and doors (FP4)
- HVAC solutions with alternative natural refrigerant with higher Coefficient of Performance (FP4)

²⁵ D2.2: Energy baseline update

Some additional energy-saving technologies with high potential are:

- Lighter wagon with improved aerodynamics
- Optimised container sequence
- Further technologies for energy saving of heating and cooling for battery and hydrogen like heat storage and individual heating

In 2022, the work on a methodology for energy label of railway vehicles based on the results of a stakeholder survey was concluded. The assessment described the other considerations which were not part of the assessment however could be more appropriate for a label such as taking into account a broader scope such as environmental performance over all life-cycle phases or environmental impact labels against other transport modes.

In addition, based on the experience using the energy quantification method, the EN 50591:2019, feedback was collected and proposals for clarification and simplifications were identified and reported in FINE-2 D2.1 deliverable.

During 2022, the delayed deliverables from past years were all submitted together with the ones planned for this year. WA5.1 has reported having accomplished 100% of the planned work up to the end of 2022. The current work represents 100% of the overall WA. The WA is completed.

WA5.2 – Noise and Vibration

The overall objective of this work area is to reduce the annoyance and exposure to noise and vibration (N&V) related to the railway sector in Europe and to provide the necessary system approach and leverage the results from all the IPs by applying effective noise control in the different technical demonstrators. The N&V work area further supports the development of simulation methodologies for exterior noise at standstill and pass-by, based on existing tools stemming from ongoing and past projects, as well as the prediction of ground-vibrations by passing trains. The outcomes will further improve the acoustic certification process for new trains e.g. during authorisation as well for impact studies on vibration prediction during the Environmental Impact Assessment for new or upgrading railway lines.

The Noise and Vibration work area was covered in the previous CFM project FINE 1 and in the OC project DESTINATE, which were accomplished in 2019. Currently, there are 3 ongoing projects, the FINE 2 member's project, and two complementary Open Call projects TRANSIT and SILVARSTAR.

Due to the Covid-19 pandemic, the activities in this work area were massively hampered by the delays incurred for the measurement campaigns. However, in 2022 all postponed measurements have now been completed. However, due to delays, projects were extended and activities were delayed until mid-2023.

For the exterior noise tools, significant progress has been achieved in 2022. After the necessary postponements due to the Covid pandemic, all measurements planned within the framework of both the CFM and OC projects, could be carried out successfully and are now being evaluated. The train equipment has been measured standalone outside the train and again when installed on the train. Two types of equipment are measured: an auxiliary converter and an HVAC system. From the standalone measurements of the equipment, equivalent monopole source data has been derived, including installation effects. The monopole source data is applied to predict the SPL (Sound Power Level) at the microphone positions used in the outdoor measurements and the prediction is compared to the measured SPL. The results are now being compared and evaluated with the various simulation tools commonly used in the industry, so that these can then be further improved to be able to rely more on computational prediction instead of complex measurements in the future.

Regarding noise sources separation, after some postponements all originally planned and remaining exhaustive measurement campaigns with a regional train in Velim (CZ) as well with Highspeed trains between Madrid and Barcelona Highspeed line (ES) in close cooperation with both the OC and CFM projects have now successfully been completed. Two aspects have separately been explored: separation of sources other than rolling noise and separation of wheels and track noise. The objective is to use these separation techniques for the pass-by certification test as a partly virtual certification in contrast to the extensive and costly field measurements currently in use.

Two methods are explored for the separation of sources other than rolling noise (aerodynamic noise, traction noise, ...): Beamforming (microphone array) and a PBA-based method. Results from the two measurement campaigns are analysed to obtain and estimate the SPL and directivity of the different methods. Both methods can separate aerodynamic, traction and rolling noise, and show promising results regarding the estimation of the directivity of the sources.

For wheel-track noise separation, the three proposed methods (Advanced Transfer Path Analysis (ATPA), Pass-by Analysis (PBA), and TWINS-based transfer functions) are applied in three measurement campaigns: a metro train, a regional train and a high-speed train. The overall reconstructed sound is within the tolerance for all methods. A moderate agreement is found between methods in the mid-frequency region and wheel/track separation is more consistent than individual track components. All in all, the results are promising and several recommendations for future improvements will be made.

Regarding the ground vibration prediction tool, the goal is the development and validation of a hybrid approach, combining numerical prediction with experimental results and to be integrated in Software for other environmental studies and graphical user interfaces (GIS level). Results show that mixed data (real measurement and numerical prediction) can be easily exported to GIS formatted data and visualized in the – vibration mapping software (2D and 3D maps). This results in a unique software platform that allows engineers to perform noise and vibration environmental impact studies within the same integrated software environment. In 2022, a prototype of this prediction tool has been finalized and validated using comparison with state-of-the-art numerical models, for 18 case histories. The ground vibration calculation kernel is now fully integrated with the existing noise mapping software used by the OC project. To ensure that the prediction tool is capable of rapid large-scale calculations and is accessible to a wide range of users, it is built around an extensive database of both measured and pre-computed data. The software is now shared with the complementary project for exhaustive additional validation to be finalized within 2023.

A further task on the ground vibration topics is to develop some procedures how to define track independent vehicle indicators (TVI). Two different TVIs were proposed, one representative of ground-borne vibration and the other of ground-borne noise and represent the overall vibration and noise levels in a nominal building on a nominal soil. The simulations were performed using generic models of passenger and freight trains and changes in the most important parameters of the vehicle are investigated e.g. wheel unevenness, primary and secondary suspension stiffness and train speed. It was shown that the proposed vibration vehicle indicator is generally robust to changes in site conditions for which the force density is calculated. The classification of the vehicle performance based on the proposed noise TVI would be less reliable when using force densities measured at significantly different sites. The consistency of results for both TVIs could be improved by applying transposition to the force density estimates, so that they correspond to the reference site.

Furthermore, the work on the advancement of the tools for auralisation & visualization was continued. The auralisation model was improved (improvement of wheel and track models, improvement of noise barrier model, etc.) and the catalog of scenarios and noise mitigation measures was expanded (wheel and rail dampers, low-height barriers, etc.). More sophisticated virtual reality scenarios were developed for the demonstrator. The user can dive into a scenario, freely rotate their head and dynamically switch between different variants (e.g. with or without noise barriers). A first version software tool is now available for testing and validating. The prototype of the software was demonstrated at InnoTrans 2022 (Berlin) and TRA 2022 (Lisbon).

Following from the conclusion of the feasibility study of new concepts and approaches on innovative materials and design tools for improved interior sound control and acoustic comfort for passengers, the UTLF (Ultra-thin low-frequency resonator) arrays for noise reduction in HVAC systems is selected for the prototype phase. Prototypes of single resonators are developed and tested in an impedance tube and an array prototype to be tested in a realistic duct set-up is built and tested.

By 2022, 21 deliverables were planned, and 11 deliverables have been released, the other deliverables were delayed due to the postponed measurement campaigns. The projects have established mitigation actions in order to recuperate from the delays and project extensions were also requested to carry out the expected work. WA 5.2 has reported having accomplished 52% of the planned work up to the end of 2022. The current work represents 75% of the overall WA.

1.2.7. IPx activities - Disruptive Innovation and Exploratory research

LinX4Rail and LinX4Rail-2 are IPx projects respectively launched in December 2019 and December 2020. Both are aiming at setting the grounds for a shared vision of the railway system architecture, as well as the development of the CDM (Conceptual Data Model) which will enable different simulation or operational subsystems to run together. This paves the way to building a shared and interoperable architecture. The work in this direction is now up taken by the Europe's Rail System Pillar.

LinX4Rail came to its end in November 2022 and delivered the prefiguring elements for the System Pillar, resulting from the regular exchanges (workshops and webinars) set up by the LinX4Rail stakeholders throughout the year 2022. The main results consist in:

- 2 consecutive releases of the System Functional Architecture. As an example, below is shown a proposed as-is overall railway system architecture,

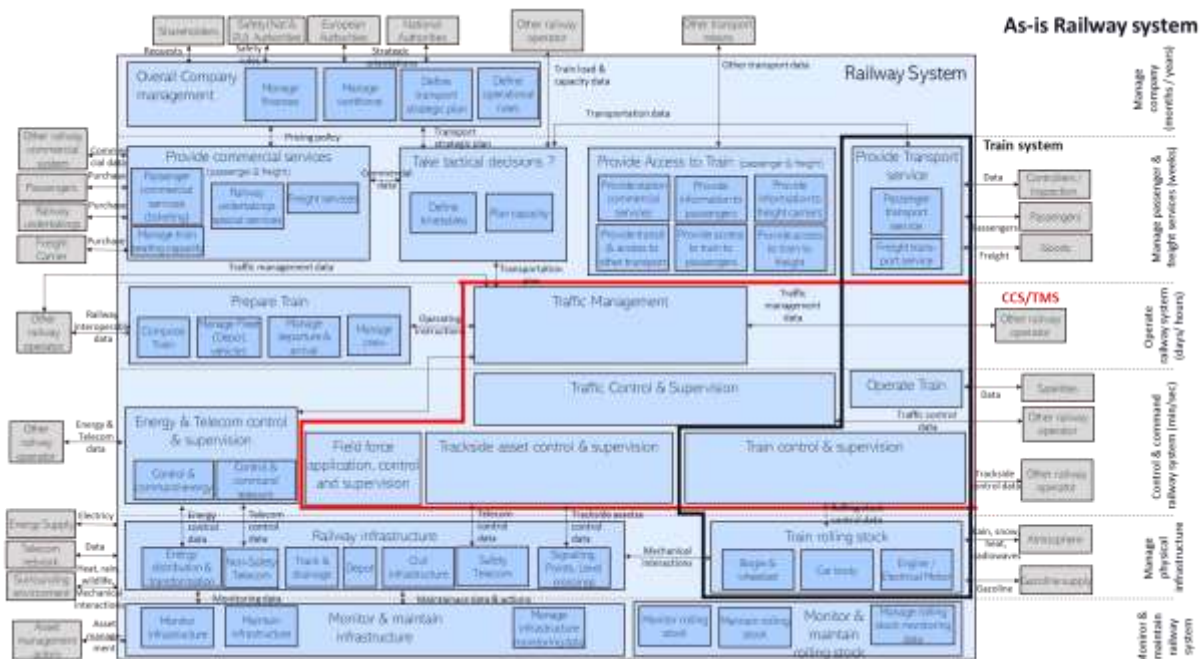

Overall railway system as-is architecture

- The specification and the set-up of the formal definition of the Conceptual Data Model;
- The demonstration of the applicability of the CDM to concrete railway scenarios through four relevant use cases;
- Keeping up to date the ontology dictionary OntoRail by regularly uploading the newest versions of the source models & providing a short YouTube video giving an overview of the LinX4Rail project, focused on the main functionalities of the railway semantic dictionary built on top of the OntoRail knowledge engine.

In-order to get a broad acceptance for the technical concepts of the Europe's Rail CDM and System Architecture, three dedicated CDM workshops have been organized throughout the year 2022.

It should be noted however that the LinX4Rail projects have been complemented by the ramp-up / launching of System Pillar. To better align these parallel activities, the LinX4Rail grant agreements has been amended to slightly adapt their scopes. The main LinX4Rail deliverables have however not been impacted.

Artificial Intelligence (AI)

RAILS (Roadmaps for A.I. integration in the rail Sector) is a Ph.D. research project launched in December 2019. The project investigates aspects related to the adoption of Artificial Intelligence in rail automation, predictive maintenance and defect detection, traffic planning, and capacity optimization. Based on the work conducted in 2021, the research carried out in 2022 aimed at:

- Developing methodological and experimental proofs-of-concept;
- Developing Benchmarks, Models and Simulations.

The goal of the proofs-of-concept is to support the definition of roadmaps, to answer research and development questions in application domains which are significant for the innovation of the railway sector, according to the analysis conducted in early stage of the project.

Proofs-of-concept have been established and are currently under development. They address the following issues specific to the railway operations:

- Railway Obstacle Detection and Collision Avoidance;
- Cooperative Driving for Virtual Coupling of Autonomous Trains;
- Predictive Maintenance for Rolling Stock;
- Smart Maintenance at Level Crossings;
- Graph Embedding for Primary Delay Prediction;
- Big Data on Incident Attribution Analysis.

The proofs-of-concept resulted in the definition of case studies that can be used as benchmarks in future research, and innovative approaches which exploit A.I. algorithms and techniques. The comparison among alternative solutions and the development of simulation tools and scenarios have also been addressed in carrying out the experiments. The main results are the following:

Railway Obstacle Detection and Collision Avoidance

An approach to effectively locating, identifying, and detecting any kind of obstacles on the railway track, by leveraging on lightweight equipment, such as a single camera mounted on front of the train. The approach uses computer vision and unsupervised learning. This proof-of-concept also allowed to underline the role played by scenario simulators and data augmentation techniques to build synthetic datasets.

Cooperative Driving for Virtual Coupling of Autonomous Trains

An approach to virtually couple two or more trains in a single convoy through a Train-to-Train communication network to reduce the headway between them, thus enhancing line capacity. The approach, leveraging tools transferred from the automotive field, focused on the development of a controller based on Reinforcement Learning techniques. This proof-of-concept also allowed to underline the role played by the simulation platforms for training and validation purposes, since datasets would be inadequate to work in concrete operational scenarios.

Smart Maintenance at Level Crossings (LCs):

An approach to monitor the health status of LCs systems (including a barrier and audio/video signals) with a specific focus on the usage of non-intrusive sensors. The approach is based on the definition of a modular architecture and exploits Convolutional Neural Network and Deep Learning object detectors. This proof-of-concept also allowed to underline the role played by videogames (such as GTA V) and Transfer Learning to cope with limited data availability.

Predictive Maintenance for Rolling Stock

An approach to continually monitor the health condition for train vehicle rolling stock with the particular purpose of reducing the overall cost of uniform rolling stock maintenance activities. This approach is represented as the job scheduling optimization problem based on a meta-heuristic algorithm that uses the particle swarm optimization method. This proof-of-concept also allowed to underline the role played by heuristic algorithms and predictive maintenance to fulfil the requirements from industrial practice needs.

Graph Embedding for Primary Delay Prediction

An approach incorporates the Structural Deep Network Embedding (SDNE) and Singular Value Decomposition (SVD) to understand and model the complex structure of the railway system from a network perspective and tries to capture a comprehensive collection of features including network topology, infrastructure, and train profile into a framework of train delay level prediction. This proof-of-concept also allowed to underline the role played by Graph Embedding and Matrix Decomposition to address traditional traffic management problem.

Big Data on Incident Attribution Analysis

An approach to interactively visualize historic train delay records and how delays were triggered by small disturbances. By deriving and learning how these disturbances lead to primary delays and their propagation along a specific route of the network, meaningful prediction insights of whether a delay will occur or cascade between particular locations, timepoints, and train services, would be generated. This proof-of-concept also allowed to underline the role played by Big Data and GNN-based techniques (such as Graph-SAGE) to construct potential propagation links between incidents.

The above-mentioned approaches are meant to support experimental research and investigate the potential of A.I. for selected railway problems. The objective is to produce recommendations, lesson learnt and roadmaps in the last phase of the project.

The project published scientific papers and participated in conferences and events. The project also organized in September 2022 the third edition of the AI4RAILS workshop series, whose first edition was held in 2020.

Blockchain

Blockchains are a disruptive technology that have the potential to accelerate the development of rail as the primary medium-distance carrier within the wider multi-modal transportation system. Essentially functioning as electronic distributed ledgers, blockchains will allow the railway industry to trace the exchange of assets between stakeholders, providing a non-volatile record of the transactions that doesn't require a single trusted authority to operate it.

The most obvious applications of blockchains within the railways centre on ticketing, but in practice the technology has the potential to impact many areas of the business. The B4CM (Blockchains as a Distributed Ledger for Attribution of Remote Condition Monitoring Data in Rail) project is providing funding for a PhD scholarship that is identifying key use cases for blockchain technology within the railways, developing a blockchain-based testbed that enables the benefits of the technology to be formally evaluated, and demonstrating the value of blockchains in the attribution of data costs from condition monitoring systems operating across organisational boundaries within the European rail sector.

Building on the deliverables issued in 2021, the project team has moved forward in 2022 to create the B4CM demonstrator, which shows how the framework (described in deliverable D1.1) can be used to implement the necessary business flows to traceably exchange blocks of data between industry stakeholders in an ad-hoc context. The demonstrator is presented in deliverable D3.1 and the project code has been made available via a public git repository, enabling users to easily access and extend the work for their needs, and can be accessed via GitHub ([link](#)). The document begins by introducing the demonstration scenario, the provision of condition monitoring data from a third-rail monitoring platform mounted on an in-service passenger vehicle to an infrastructure manager in raw and processed forms, before explaining how that scenario is realised within the framework.

The conclusions of the B4CM project are reported in deliverable D5.2 which also includes the recommendations for the use of the technology in the industry in the future.

Copies of the deliverable documents and publications produced by the team to date are available via the project webpages at <https://www.b4cm.co.uk>.

Innovation in Power Supply

Flexible medium voltage DC electric railway systems (MVDC-ERS) project: December 2018 - April 2022.

The aim of flexible medium voltage DC electric railway systems (MVDC-ERS) project was to propose a new type of MVDC traction power supply based on controlled bidirectional converters to improve the connectivity of the railway to the grid and to integrate renewable power sources to the railway electrification system. With reference to the on-board traction system, the project investigated DC power electronic traction transformers (PETTs) to adapt the catenary voltage for the traction system of the trains.

In 2022, a lab demonstrator of a modular multilevel converter was developed and used to test a small-scale MVDC traction substation in various load conditions. The hardware arrangement, the controller programs, and the experimental results have been reported in the technical deliverable D1.3.

Moreover, two converter topologies for PETF, named dual active bridge converter and phase-shift full-bridge converter, were experimentally examined. The mathematical model of two converter topologies along with the design equations of their controllers, their software models, and the results obtained in the simulations and experimental measurements have been presented in the technical deliverable D2.2.

The project findings were also presented in World Congress on Railway Research (WCRR) 2022 and 16th IEEE International Conference on compatibility, Power Electronics and Power Engineering (2022 CPE-PowerEng). In addition, a review paper on feeding arrangements and power converter topologies in Medium-Voltage DC Electric Railway Systems was published in IET electrical systems in transportation journal (<http://doi.org/10.1049/els2.12054>). The final project summary report (D4.2) together with other deliverables and publications are available at <https://www.birmingham.ac.uk/mvdc-ers>.

Autonomous Train Operation

The year 2022 has been a fruitful for the IPX project TAURO, whose research areas have progressed significantly making relevant results already available.

One of those was the design and prototyping of a rail common database for perception scenarios (also known as data factory). A complex data management platform was envisioned, inspired by the modern concept of data lakes, often used in the automotive sector and popularized by cloud-computing providers.

The purpose of this approach is to not only store raw data, but also to provide the user with tools to label, analyze and process data and simplify training and testing AI models, aiming to eventually automatize the whole AI development pipeline. A reference implementation of the database using private cloud services is proposed as opposed to having it internally hosted by contributors or a European legal body. As one key advantage, this is a more stable solution when it comes to ensuring access to data anytime. Amazon Web Services (AWS) is considered to be a suitable option for this purpose after reviewing several alternatives (mainly thanks to the Amazon SageMaker platform, which has features well aligned with the defined database requirements). Finally, one of the most important outcomes of this activity is the implementation of a proof of concept of the database, where a practical approach was given to the theoretical concepts obtaining successful results.

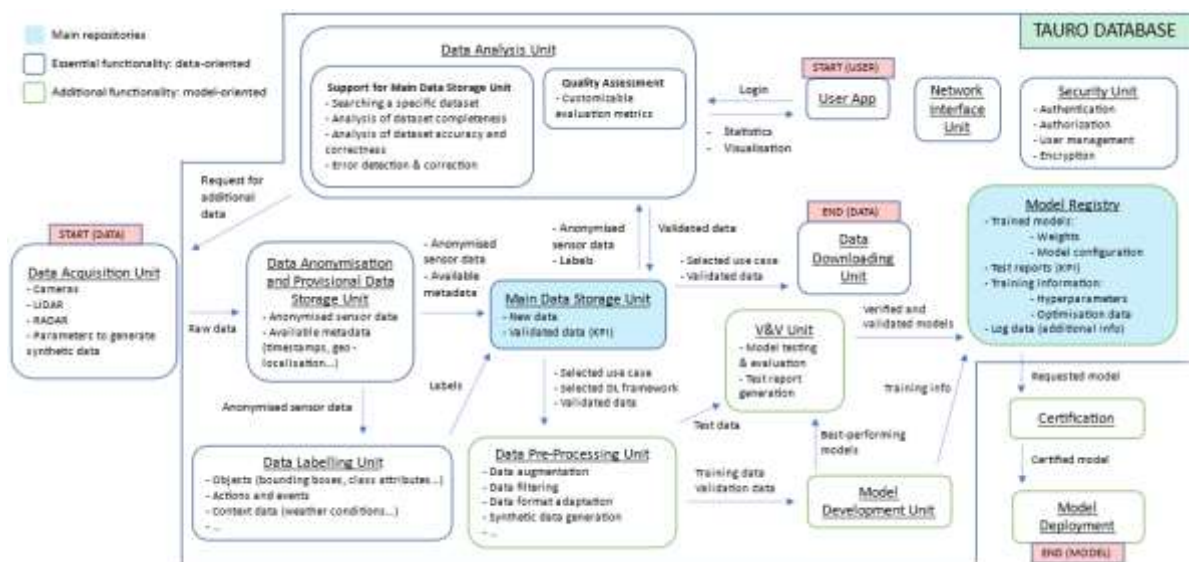

Functional architecture of TAURO's database

The exploratory activities on enhancing the train positioning systems through additional perception sensors started in 2022, bringing the possibility of using SLAM – Simultaneous Location and Mapping - in railways. For that purpose, an urban rail vehicle (tram) was modified by fitting radars, lidars and cameras, and tests began in Summer in the Spanish city of Zaragoza under commercial service. First results are promising,

and the experiments will continue in the next months. An explanatory video was produced and unveiled at InnoTrans 2022²⁶.



Modified tram to test SLAM

Another relevant research area of TAURO tackles remote driving and command functionalities. The activities in 2022 focused on the definition of the architecture for the selected three use cases: Remote driving under ETCS, in freight shunting yards and in depots for tramways.

The scope was the definition of a common functional architecture for remote driving function, which could be applicable to different train segments and for diverse applications, and regardless of the underlying signalling system. In addition, this resulting architecture is also telecommunications unaware, being able to work regardless of the underlying wireless networks. Thus, this architectural solution could be the basis for a standardization process of an architecture supporting automated operations.

The architectural solutions emerging from this common architecture are simple, affordable and safe. Besides, these solutions are open and interface standardised, modular, scalable and evolvable to allow progressive deployments, thus minimising the investment risk and ensuring upgradeability and component interchangeability.

The specification of the architectural solutions is complemented by safety and cybersecurity analyses, whose results have been an important input to improve the proposed architectures.

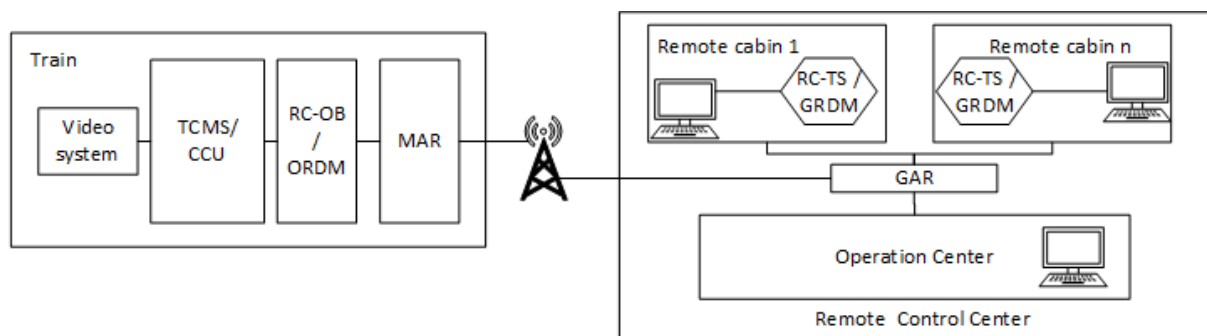

High-level common functional architecture for Remote Driving

On the other hand, full automation is not just the automated driving (i.e. executing the mission) but a set of other functions to guarantee the mission safety and reliability. In 2022, TAURO has identified which functional test must be performed on autonomous trains at the start of the mission and has generated high level use cases which can be taken as reference by other projects within the Programme, such as X2Rail-4.

²⁶ <https://www.youtube.com/watch?v=eEGg3I37avc>

But going upwards to the network level, TAURO has performed an analysis on the stability of the automated operation which required the finding of the parameters that can be modulated to reduce the headway to minimum braking distance. The definition of these parameters is linked with:

- Train performances (speed of calculation, braking performances);
- Timetable management (specific drivers, robustness management);
- Network performances (more precisely the GSM-R and the localisation).

Several parameters can play a strong role in the headway performance. If the consideration of the parameters is implemented, it can not only help to reduce the headway to minimum braking distance but also improve the capacity of the line. If trains are more performant, less headway is required and hence the capacity can be increased. Or the same number of trains can be run and hence the quality of the service can be upgraded.

Those parameters were analysed and it was determined in what extent they would have an impact on the headway. Use cases were generated for the analysis process.

Finally, the project has also been preparing itself for transferring the produced results and knowledge to the new projects stemming from the first call of Europe's Rail, especially the Flagship Area 2 project FP2-R2DATO. A list of suitable transferable documents, presentations, and other relevant dissemination items has been prepared by the work packages' participants. Workshops are expected to be organised at the beginning of 2023.

1.3. Research & Innovation activities/achievements: the EU-Rail Programme

1.3.1. System Pillar

Outputs of the System Pillar Ramp-up

The ramp-up phase contributed to the building of the System Pillar by delivering the following activities:

1. Design a top-level target Control-command and signalling (CCS) system architecture, being ERTMS radio-based with a harmonized operation.
2. Define a migration roadmap, providing implementation strategies from existing legacy signalling system architectures towards the target system architecture.
3. Achieve broad acceptance of deliverables (proposed innovations) by railways and suppliers, being consistent with the rail sector's Common Business Objectives.
4. Use available inputs from all existing railway architecture initiatives in the project, as long as they comply with the objectives mentioned above.

Derived from that objective, the System Pillar Ramp-Up Consortium was arranged under the Specific Contract 5 with the following objectives:

Work packages	Objectives for this specific contract
Part 1: System Pillar core group	Provision of 6 senior experts [2 from railways, 4 (half-time) from suppliers] to form the System Pillar Core Group.
Part 2: Top level architecture for CCS+, considering all existing initiatives, and input for Innovation Pillar	<ul style="list-style-type: none"> • Definition of high-level CCS+ system architecture • Future operational concept for CCS+ • High level migration principles for CCS+
Part 3: Conceptual data model contribution and tools/methods (including training) for representing the System Pillar outputs	Provision of experts to support Linx4Rail in the correct definition of ontology/dictionary from a CCS+ perspective

The work performed in the different parts is outlined as follows:

Part 1: System Pillar Core Group

The objective of part 1 was to already start the work of the System Pillar Core Group in the ramp-up phase of the Europe's Rail Joint Undertaking.

The following work has been performed:

- **WP P1.1** SP<>IP (Initial System Pillar requirements and interaction with the Innovation Pillar)
- **WP P1.2** Analysis of Common Business Objectives (CBO)
- **WP P1.3** Task1/Task2 Planning
- **WP P1.4** Guidance for the Innovation Pillar
- **WP P1.5** High-level Target Architecture
- **WP P1.6** Operational Concept
- **WP P1.7** Governance SP

Additionally, the following management and interaction tasks have been carried out:

- Interaction with the Innovation Pillar,
- Guidance for SC5 Part 2.

The outcome of this is represented by the following deliverables:

- **DP1.1.** Initial System Pillar requirements and interaction with the Innovation Pillar from Task 1 to Task 2 including integration plan for existing initiatives.
- **DP1.2.** Analysis of Common Business Objectives for the definition of priorities.
- **DP1.3.** Definition of the priority activities with day-to-day planning both for Task 1 (EU-Rail System) and Task 2 (CCS+) for the next 3 to 5 years.
- **DP1.4.** Guidance for the Innovation Pillar on Flagship Areas.
- **DP1.5.** First draft of a high level logical and physical architecture with targets for the system architecture to be achieved in terms of high-level principles of system architecture granularity.
- **DP1.6.** First draft of the operational concept(s).
- **DP1.7.** Governance organisation within the System Pillar and in particular the role of the Core Group (See EU-Rail Governance and Process Handbook).

Part 2: Top-level architecture for CCS+, considering all existing initiatives and input for Innovation Pillar

The objective of this part was to define the first draft of the target CCS+ architecture and related operational concept at top-level and the high-level principles for migration from class B systems towards this target architecture.

This first draft was based on the usability assessment of several initiatives that have been launched in the past years with the aim to increase the performance and to lower the costs of Command, Control and Signalling systems: ERTMS, EULYNX, Shift2Rail (IP2 and LinX4Rail), RCA and OCORA. This assessment was complemented with a first exploration of the other domains of CCS+.

The following work has been performed:

- **Line side CCS assets:** The roadmap for the next EULYNX release under the System Pillar umbrella has been taken forward under this domain.
- **Trackside protection:**
At first, a set of relevant documents has been collected as a reference baseline from various existing initiatives and current standards: TSI CCS, RCA, EULINX, LINX4RAIL, S2R X2Rail, EEIG ESG. The documentation set has been included in DP2.1.

The work related to the target architecture, starting from CBO, lead to:

- a comparative analysis of the major functions of Traffic CS System among the different approaches and points of view from the existing initiatives (first release of the DP2.2 Annex 2 - Traffic CS section).
- a “System Analysis” of the Traffic CS System compliant with the architectural principles depicted in DP2.2 Annex 1 and developed in strict cooperation and alignment with the Architecture & Migration domain (second release of the DP2.2 Annex 2 - Traffic CS section, which includes both the comparative analysis of the previous standards/initiatives and the “System Analysis” of the Traffic CS System inside the CCS/TMS System of Systems).
- Even if the “System Analysis” cannot be considered completely consolidated, it has already reached a good coverage of all “Capabilities” which are allocable to the Traffic CS System and represents a good starting point for the next steps.

A further contribution has been provided by discussing the migration topics and commenting drafts of DP2.3.

- **On-board CCS:** The approach has been defined and activities harmonized and coordinated within the domain and with other domains.
- **Radio/FRMCS:** The topic has been monitored, considering:
 - Any subject that could influence OBapp.
 - Any subject or issue that could link to the usage of FRMCS, including opportunities for improvements.
- **Traffic Management System:**
 - Collected documents as a baseline from Shift2Rail, In2rail, LinX4Rail.
 - Alignment with the mirror groups as well as with CCS Platform.
 - Participation in the workshops for “Architecture & Migration”.
- **Track worker Safety:** This domain has not been addressed. No substantial input for elaboration was available.
- **Architecture & Migration:** Deliverables DP2.2 Architecture and DP2.3 Migration Principles were completed.
- **Operational Harmonisation:** HOP objective was the definition of a methodology for operational processes harmonization. The proposed methodology for operational processes description is derived from RCA project and is based on ARCADIA. Joint workshop, with participants from UNISIG and Railways mirror groups, analysed nominal and degrades situations to evaluate the effectiveness of the proposed methodology.
- **Cross Cutting CCS / service functions:** The different activities within the domain were synchronised.

The outcome of this part takes form of the following deliverables:

- **DP2.1.** Identify input from work already undertaken in RCA, OCORA, TSI CCS & OPE, S2R (in particular ERA TWG ARCHI) etc. against the baseline work of LinX4Rail and System Pillar Report (M4 and refinement M9).
- **DP2.2.** Definition of the CCS+ top-level target system architecture and identification of CCS+ interfaces (for example in terms of FFFIS specification development) / standards, system architecture granularity, including compatibility schemes with FRMCS (M6 and refinement M10).
- **DP2.3.** Migration principles for CCS+ as a whole system, incl. functional and RAMSS considerations (M8 and refinement M10).
- **DP2.4.** Proposals on future operational concepts for fitting to the CSS+ top-level target system architecture and assessment on impact on architecture (M5 and refinement M10).
- **DP2.5.** Definition and modelling of initial System Pillar input to the Innovation Pillar Flagship Areas (M3 and refinement M10).
- **DP2.6.** Report assessing potential impact on FRMCS.

Part 3: Conceptual data model contribution and tools/methods (including training) for representing the System Pillar outputs

The outcome of this part was the following deliverable:

- DP3.1. Feasibility study on the inclusion of System Pillar operational models into the LinX4Rail CDM approach.

Setting-up of the System Pillar

The System Pillar Steering Group was successfully established. The work performed by this body is further described in Section 3.7 of this CAAR.

Governance and working arrangements and structure

Organisation structure

The governance structure has been set in 2022, with the System Pillar Core Group, under the supervision of the EU-Rail Executive Director and/or his delegated Head(s) of Units, is leading the day-to-day work of the delivery of the System Pillar through the Tasks and with the support of Engineering and Administrative support services. It manages progress of and collaboration between the Tasks.

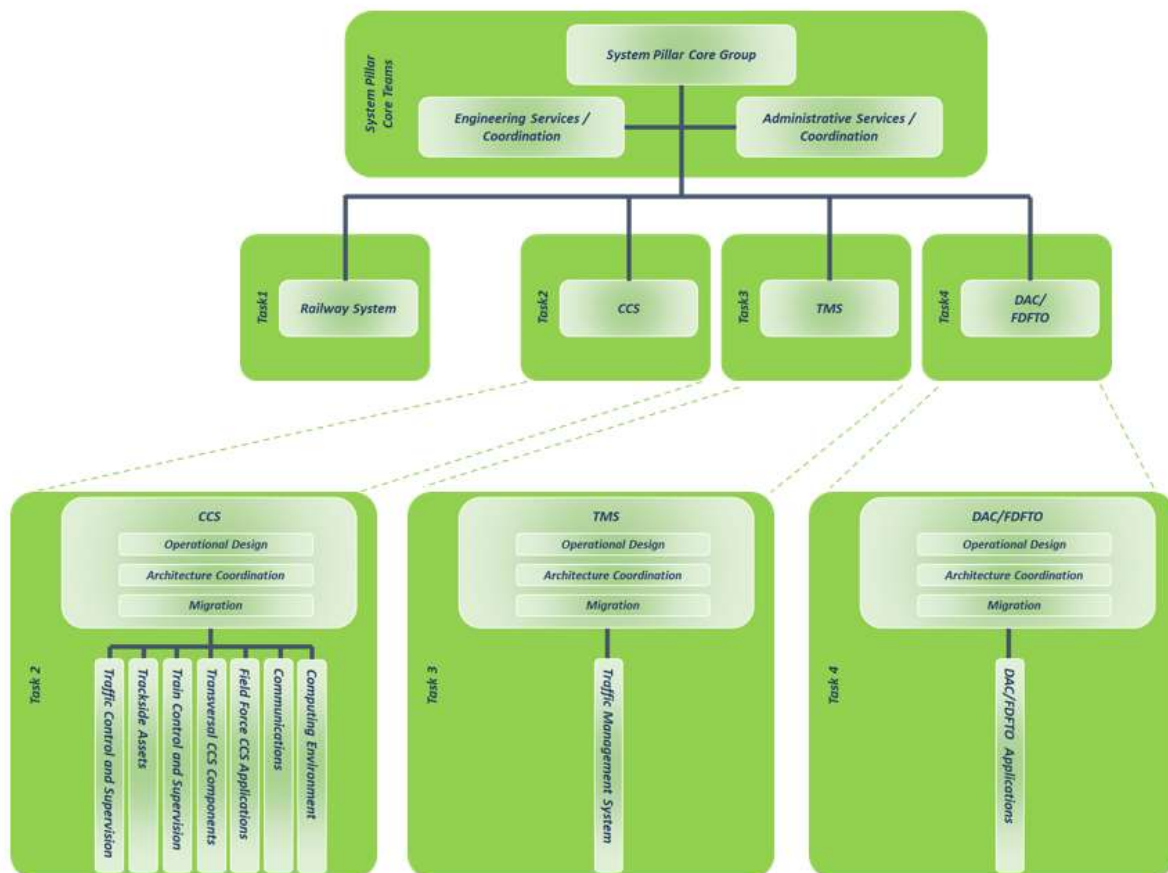

Structure of the System Pillar

The **System Pillar Engineering Services / Coordination** consist in:

- **The Modelling Service:** includes methods & tools definition for the whole System Pillar, support of the modelling platform, and derives and maintains the CDM catalogues.
- **Standardisation and TSI Input planning:** structured along the catalogue of processes and interfaces/systems - describes the process of collecting and assessing IP and SP input to the harmonisation channels including regulation (TSI), standardisation (CEN/CENELC, ETSI) and System Pillar Industrial standards (SP documents).

- **External Architecture Support:** central pool of (external) architects aimed to support the SP Core Group (e.g. architectural issues on top level), the modelling service, the tasks or single domains on demand.
- **PRAMSS Management & Assurance Team:** Coordination of the PRAMSS requirements.

The System Pillar **Administrative Services** consist in:

- **Programme (Management) Office:** Support all the activities of the System Pillar, including management of:
 - Progress
 - Quality
 - Resources and administration
 - Communication
- **Economic Analysis:** economic analysis supporting the activities of the System Pillar (e.g. cost-benefit, enhancement change request, specific business cases, etc.).

Task 1: Railway System

Task 1 consists in defining the Business Process Architecture and Operational Design (Organisational needs, Generic automation needs, ...) for the Railway System, based on and reflecting the Common Business Objectives.

During 2022, the Task 1 remit was completed, and the following tasks were started:

- First planned inputs for the Standardization and TSI Input Plan (STIP).
- Definition and prioritisation of use cases of the full railway system (starting with input from Linx4Rail and Linx4Rail2) to be considered, where necessary, in further as-is analyses.
- Contributions to the Central Modelling Service (using Polarion, Capella as appropriate).
- Assign input requirements to other tasks.

Task 2: CCS

Task 2 consists in developing the operational concept(s) and functional system architecture for a genuine integrated European CCS system, supported by a model-based systems architecting & engineering approach, beyond the current specifications in the CCS TSI, with much greater standardisation and much less variation than at present.

Task 2 is structured in Domain teams for cross-cutting activities and (Sub-)System Design activities that need to be managed and coordinated:

- **Cross-cutting activities**
 - The Operational Design Team
 - The Architecture and Release Coordination Team
 - The Migration and Roadmap Team
- **(Sub-)System Design activities**
 - The Traffic Control and Supervision Team
 - The Trackside Assets Control & Supervision Team
 - The Train Control and Supervision Team
 - The Transversal CCS Components Team
 - The Field Force CCS Applications Team
 - The Communications Team
 - The Computing Environment Team

During 2022, Tasks and domain remit documents were finalised (except Task 2 communication domain).

Task 3: Traffic management System/Capacity Management Design Team

Task 3 consists in developing the operational concept(s) and functional system architecture for the Traffic Management System/Capacity Management. Task 3 is structured around the Traffic Management Team,

handling both cross-cutting activities and (Sub-) System Design activities. During 2022, Tasks and domain remit documents were finalised.

Task 4: Digital automated coupling (DAC), Full Digital Freight Train Operations (FTDFTO)

Task 4 consists in developing the operational concept(s) and functional system architecture for the Digital Automated Coupling (DAC)/ Full Digital Freight Train Operations (FTDFTO). Task 4 is structured around the Traffic Management Team, handling both cross-cutting activities and (Sub-) System Design activities. During 2022, Tasks and domain remit documents were finalised.

System Engineering Management Plan (SEMP)

The SEMP defines the workflow rules and arrangements, methods, and tool usage for all specification related activities in the System Pillar.

It is essential that all SP tasks and domains, and linked work, follow the SEMP processes to enable the large and dispersed group of people working within the System Pillar to speak the same language and follow common processes.

The work to elaborate the SEMP began in July/August 2022 – with voluntary input from the sector, with an initial draft delivered in October 2022.

An update took place at the SP-STG Meeting 2 and after that the version 1 of the SEMP was drafted (delivered in November 2022).

This SEMP version 1 was aimed for the start of the System Pillar, that is, to enable the SP tasks and domains to begin to work. It only includes the currently necessary description of workflows and methods. It will be extended and refined over time by the Modelling Service Team.

SEMP V1 was reviewed by the:

- Central Modelling Service
- Task and Domain leads
- SP Core Group

Based on that review, several critical points have been identified in the SEMP V1, and enhancement approaches were proposed. Where different approaches are needed, based on the return of experience, changes will be proposed in SEMP V2. Additionally, a number of open points have been identified in the SEMP V1 as well. These points will be developed for further refinement to be proposed in SEMP V2.

During the SP-STG Meeting 3 in November 2022, the SP-STG:

- Took note of the SEMP Version 1 Annexes as a working basis and starting point for the SEMP refinement process.
- Endorsed the SEMP Version 1 for starting the work in the System Pillar teams.
- Noted that the Central Modelling Service will refine and update the SEMP including the Annexes, based on new feedback received, the experience of implementation, and on the list of open points in the last chapter of this document.

SEMP: Basic workflow per task

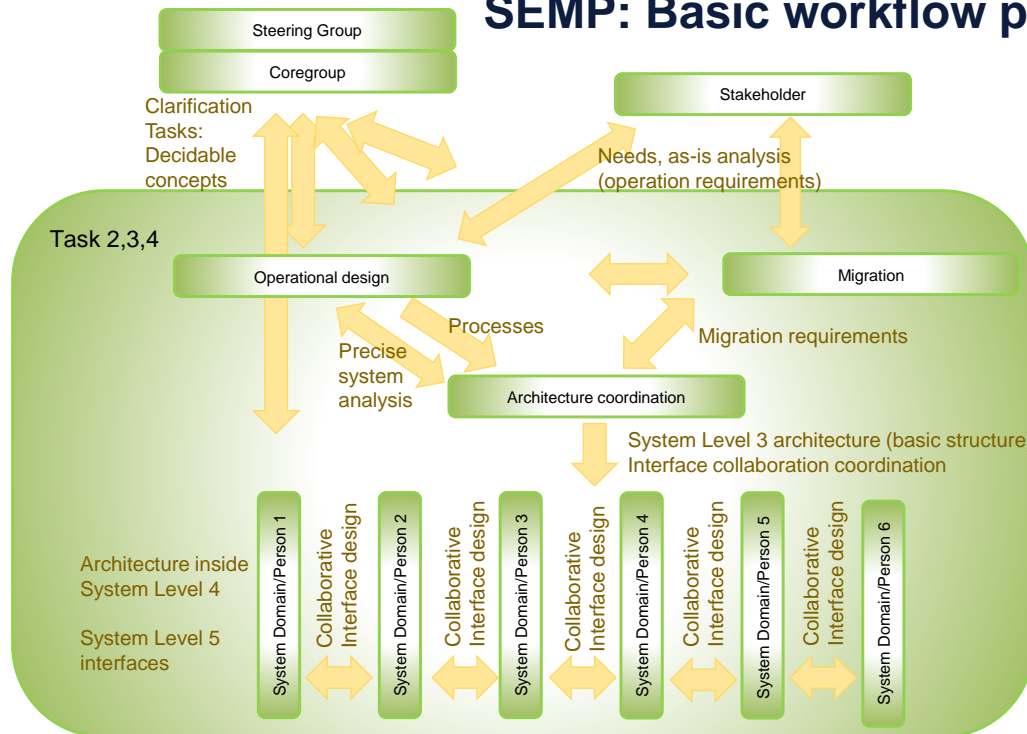

Platform and tools

The SEMP V1 makes use of a temporary/basic tool architecture for the start of the SP (“basic platform”).

Common Business Objectives (CBO)

The CBO were derived from the identified impacts from the EU-Rail Master Plan and are based on the importance of delivering an overall system view, strengthening the delivery of the Single European Railway Area (SERA).

The EU-Rail Master Plan identified impacts used to derive the common business objectives:

- Meeting evolving customer requirements,
- Improved performance and capacity,
- Reduced costs,
- More sustainable and resilient transport,
- Harmonised approach to evolution and greater adaptability,
- Reinforced role for rail in European transport and mobility,
- Improved EU rail supply industry competitiveness.

For each Master Plan impact:

- A contextual description was provided,
- The high-level objectives to achieve this impact were described,
- The common business objectives are the listed steps necessary to achieve these high-level objectives.

The business objectives have to be managed in combination and not in isolation e.g. increased cost efficiency and quicker rollout of solutions with increased performance shall be achieved in a combined way. Pure cost reductions will not lead to higher system performance and without an accelerated rollout it will take too long to achieve a relevant modal shift.

The version 1 of the CBO document was delivered in July 2022.

CCS/TMS Operational Vision

The CCS/TMS Operational vision is intended to be the starting point for the top-down discussion about the operational concept. It defines general directions and the ambitions for the future CCS and TMS/CMS target systems as a discussion basis. It shall set the frame for more detailed discussions in the System Pillar, structured along the operational process areas.

The operational vision has been elaborated from the CBO (Common Business Objectives), by translating them into a compressed vision for CCS and TMS/CMS from the operational perspective. Additionally this vision was also influenced by the analysis of several future operational concepts or approaches of Shift2Rail (e.g. ATO, Moving Block, LinX4Rail), existing concept from initiatives (e.g., EULYNX, RCA, OCORA), ongoing enhancement discussions for the TSI CCS 2022 (e.g. for enhanced shunting and better support for ETCS Level 3 operations) and large railway programs (Target190 in NetworkRail, Digitale Schiene Deutschland in Deutsche Bahn, smartrail4.0 and succeeding projects in SBB, Hybrid Level 3 Concept).

This vision is structured into three different conceptual areas (see also ISO 15288):

- CONOPS: Concept of operations,
 - Characteristics and requirements from business view
 - Major inter-company interactions on business level
 - Legal concepts and constraints
 - Shared sector and company structures (templates or standard services)
- CONUSE: Concept how to use the system
 - Concept for the production processes
 - Parameters, constraints, and rules of system usage
- CONEMP: Concept of employment
 - Asset management processes (plan, build, run, maintain, change, disinvest)

The version 1 of the CCS/TMS Operational vision document was delivered in July 2022.

1.3.2. Innovation Pillar

The Innovation Pillar is structured in 7 Flagship Areas leading to large scale demonstration as defined in the SBA, complemented by Transversal Topics which ensure the engineering integration of the Programme.

The year 2022 was synonym of preparation for the launching of these major Flagship Areas. After the initial definition of the Flagship Areas during the initial set-up of the new Programme, the Joint Undertaking launched on 10 March 2022 the first call for proposals, thus initiating the first steps towards phase 1 of activities for the Flagship Areas. The JU, supported by independent experts, evaluated the proposals received over the Summer 2022 and the Governing Board awarded 6 proposals, which will implement the first 6 Flagship Areas.

During the phase of Grant Agreement Preparation, focus was brought on ensuring the links between the different Flagship projects and the System Pillar. Grant Agreements were signed at the end of the year and all projects were formally launched on 1 December 2022. It is to be noted that the action stemming from the topic related to Flagship Area 5, awarded officially in August 2022 (and for which the Grant Agreement was signed in December 2022 – FP5-TRANS4M-R)) anticipated the start of its activities in July 2022 in order to address activities related to automation and DAC.

Finally, the JU also put the focus on developing a new process for assessing the technological developments. This mechanism, called “Maturity Checkpoint”, has been created in the new Programme to ensure that the technical activities are 1) on track, from a timing and quality standpoint, 2) reaching the right TRL in order to ensure delivery of demonstrators at the end of phase and 3) ensure a sectoral alignment on the solutions developed by ensuring a cross review with other linked FPs but also with the System Pillar (including also the involvement of the European Union Agency for Railways - ERA). Key technical deliverables, agreed upon during the Grant Agreement Preparation phase, will be reviewed by these projects and entities in order to ensure the highest degree of alignment of EU-Rail with market needs. This

new process, which will also be supported by independent technical experts, has been developed and will be not only fine-tuned, but also implemented in 2023 for the first time in all 6 FPs.

The first EU-Rail **Flagship Project 1 – MOTIONAL** – implementing FA1 and TT is notably focusing on two work-streams:

WS1: Network management planning and control & Mobility Management in a multimodal environment delivering by 2025/2026 innovative solutions to be demonstrated with:

- Tactical and short-term timetable planning including cross-borders with improved models and functions; use of decision support to support integrated capacity planning of the rail network and operations for yards, stations, terminals [TRL4/7];
- HMI for TMS with decision support modules, based on User Experience (UX) Design and human-in-the-loop awareness [TRL4-8];
- Demand-driven predictions to improve operations and service offers, considering information about events across modes. Effect of cross-regional, multimodal travels in combination with demand forecast and disruption handling on improvement of daily operations, benefit on customers (accessibility and attractiveness) [TRL 4-8].

WS2: Digital Enablers delivering by 2025 the following:

- Connectors for Federated Data Spaces [TRL6];
- Common Domain Ontology, building upon S2R works on Conceptual Data Model (CDM) [TRL6];
- Digital Twin support, development and execution environment [TRL5];
- Common Domain Ontology/Conceptual Data Model [TRL6].

The first EU-Rail **Flagship Project 2 – R2DATO** - implementing FA2 and delivering the following by 2025:

- Demonstrate technical and functional enablers such as ATO GoA3/4 over mixed radio based ETCS levels (TRL6 or higher), Hybrid Level 3, moving block and TMS (TRL6), connectivity (TRL6), perception (TRL5/6), train positioning (TRL5/6), automated functions and digital register (TRL6);
- Demonstration of the remote driving and command in depots and yards, including perception systems (TRL6);
- A first demonstrator on next generation ATC, with modular onboard and trackside ATC architectures, at proof-of-concept stage, in close collaboration with the EU-Rail System Pillar;
- A proof-of-concepts and/or validation in laboratory and field (i.e., up to TRL4/5 in Lab and TRL6 on site) for the following new functions and technical enablers:
 - Virtual Coupling Train Set (TRL4/5);
 - Self-driving wagon (TRL4/5);
 - Autonomous path allocation (linked to input from Destination1) (TRL5);
 - Validation and certification (TRL6);
 - Demonstrate a Functional Open Coupling System prototype covering all required subsystems in an operational environment (TRL7);
 - Demonstrate a modular hardware platform using architectural software design patterns and methods (TRL7) allowing SIL2 respective SIL4 (depending on the application).

The first EU-Rail **Flagship Project 3 – IAM4RAIL** - implementing FA3 and delivering the following solutions that can be demonstrated by system approaches of the various developments targeting up to TRL 6 as European common integrated solutions, by 2025/2026:

- Asset Management & TMS. The main aim of the demonstrator shall be to show the integration between the Intelligent Asset Management System (IAMS) and the Traffic Management System (TMS) enabling the share of data and optimising decisions using common metrics – TRL6;
- Asset Management & Rolling Stock. The main objective of this demonstrator shall be to present the monitoring of rolling stock (including on board and wayside technologies) leading to decisions and planning of interventions, and redirecting rolling stock to workshops to execute the (re)scheduled work both manually as well as by new technologies and solutions to conduct inspection tasks automatically – TRL6;

- Long Term Asset Management. Development of Life Cycle Cost (LCC) models for infrastructure and rolling stock. This demonstrator shall include cross-border infrastructure remaining useful-life analysis and space-time cross-analysis and visualisation – TRL6;
- Asset Management & Infrastructure. The objective shall be to integrate on-field and on-board systems with central platforms capable of managing Big Data to enable prescriptive interventions, minimising dangerous situations and service disruptions during operation – TRL6;
- Asset Management & Digital Twins. The focus shall be on design, maintenance, upgrade and renewal interventions driven by Digital Twins for the optimisation of processes, maintenance planning and involved logistics. This shall enforce the use of BIM to standardise system configuration and AI tools to execute simulations and predictions. The Digital Twin demonstrator shall include visualisation, prediction and simulation – TRL7;
- Design & Manufacturing. This demonstrator shall be the showcase of eco-friendly production of resilient assets supported by new fabrication techniques such as additive manufacturing (focused on infrastructure assets) – TRL5;
- Robotics & Interventions. The focus of this demonstrator shall be the showcase of high-tech automated execution solutions for construction and interventions supported by robotics and wearables, among other devices, building a safer and more automated railway environment - TRL5/6.

The first EU-Rail **Flagship Project 4 – RAIL4EARTH** - implementing FA4 and delivering the following by 2025/2026:

- Alternative energy solutions for the rolling stock at TRL6, covering:
 - High performances Batteries Electric Multi-Unit (BEMU) train (reaching TRL6/7);
 - Hydrogen hybrid trains with test of heavy-duty inspection vehicle and loco for freight-passengers;
 - Sub-urban catenary trains with on board Energy Storage Systems (ESS);
 - Auto adaptive train energy consumption to various services situations;
- A holistic approach to energy in rail infrastructure (design, production, use and intelligent management) at TRL6, covering:
 - Rail Power Smart Grid in different systems as well as the integration of energy storage solutions;
 - Application of solutions for the production, storage and refuelling of hydrogen for railway vehicles on the example of a prototype refuelling station;
- Sustainability and resilience of the rail system in a holistic approach to asset management, delivering more value:
 - Development of solutions and models for the reduction of noise and vibrations from railway infrastructure and rolling stock and to predict the effect of degradation, of maintenance and of noise perception (TRL6);
- Improvement of electro-mechanical components and sub-systems for the rolling stock, at TRL6, covering:
 - Technological solutions for the migration to the airless train: Electro-mechanical braking system and novel electro-mechanical pantograph and suspensions;
 - Optimised motors and gearboxes, high performance bogies, suspensions and new materials;
 - Eco-friendly HVAC system technologies;
 - Aerodynamic certification with experimental and numerical methods;
- Healthier and safer rail system, covering:
 - Simulation tools for improving the air quality in trains, stations and tunnels (reaching TRL7);
- Attractiveness, at TRL6, covering:
 - Modular rolling stock interiors providing easy access (incl. PRM) and new architectures for drivers' cabin.

The first EU-Rail **Flagship Project 5 – TRANS4M-R** - implementing FA5 and focusing on two work-streams:

WS1 Full digital Freight Train Operations with DAC as enabler for full digital freight train operation delivering by 2025 the following demonstrators:

- European full digital freight train operations: (TRL 8-9) Large-scale demonstrator showing full digital freight train operations based on DAC Type 4 (incl. energy supply & data/communication solution and Type 5 upgradability, DAC wagon retrofitting and DAC – Hybrid for locomotives) in different regions with several train sets under real operational conditions including technical enablers described in scope section;
- European full digital freight train operations: (TRL 7) Proposals are expected to deliver within the large-scale demonstrator with a lower TRL level for technical solutions for parking brake system, digital wagon inspection (including rolling stock and infrastructure assets), DAC-based telematic applications for customer requirements (goods monitoring) / for asset performance management / CBM / for safety related applications, distributed power system and electro-pneumatic brake;
- European full digital freight train operations: (TRL 8 – some functionalities at lower TRL Demonstration of Yard automation equipment, wagon identity system allowing automated shunting, video gates and way side check points with visual recognition and AI tools for yard automation.

WS2 Seamless Freight with easy access and reliable (intermodal) transport service offering digital solutions delivering by 2025 at least the following:

- Seamless freight corridor (TRL 5-8): The comprehensive innovations for planning and operation of cross-border freight trains should be demonstrated on (parts of) two European corridors. Freight specific pilot implementations of key enablers for intermodal predictions, improved cross-border timetable planning, management and path-ordering systems taking into account also last mile service, as well as for real-time interaction between various TMS (including yards/terminals). Digital technologies for standardized European Railway checkpoints at borders or other operational stop points. Integrating and connecting the last mile (accession lines/shunting/yards/terminals) slot planning directly or via interfaces;
- Seamless multimodal freight (TRL5-8): Seamless planning, management and booking of multimodal rail-based transport integrating multi-actors, should be demonstrated integrating rail in modern supply chains. Improved routing engines more responsive to changing demand, disruptions and customer requirements. This demonstrator will ease end customers to interface with rail.

The first EU-Rail **Flagship Project 6 – FUTURE** - implementing FA4 and delivering the following by 2025/2026:

Regional Railway System (CCS & Operations) Demonstration

- Demonstrate a single integrated Operations Control Center (OCC) covering interlocking, radio blocking and traffic management for regional lines that are not functionally/operationally connected with mainline (TRL 4/5);
- Demonstrate simple on-track radio network based on the findings in FP2 related with cost-effective communications, supporting all FRMCS applications, minimizing civil works and energy consumption, to the achievement of cost-effective Gigabit Train, the use of public network coverage and compatibility with main lines (TRL4/5);
- Demonstrate a specific application for Traffic Management Systems for regional lines improving resilience of a connected rail network, optimizing train operations including disturbing events taking into account high/low-demand situations (disturbance and distraction) (TRL 4/5).

Assets Demonstration

- Demonstrate a systemic approach with the implementation of different railway assets in particular for cost-efficient wireless, energy self-sufficient wayside components in particular CCS track-side components (e.g. switches, level crossings) and if applicable for track vacancy detections and signalling shall be evaluated and demonstrated (TRL4/5).

Suitable customer services

- Demonstrate cost-efficient integration of on-board information of multimodal services integrating regional multimodal services such as carsharing (TRL4/5);
- Demonstrate passenger congestion rate monitoring, flow optimization application as well as a low-cost passenger information system for regional services developed within this action (TRL4/5).

Additionally, in 2022, the JU launched a second call to cover the Flagship Area 7 on “Innovation on new approaches for guided transport modes” and the “Exploratory Research and other activities”. This latter call was still under evaluation, as planned, at the beginning of 2023.

1.4. Calls for proposals, grant information and other funded actions

1.4.1. Grants

Considering the annual budget availabilities and the EU-Rail Multi-Annual Work Programme and Work Programme 2022-2024, the EU-Rail R&I activities are implemented through combined and interdependent multi-annual Projects. This structured interdependence of the EU-Rail Projects is based on the mutually integrated System and Innovation Pillars, complemented by the work of the Deployment Group.

In 2022 the Europe's Rail Joint Undertaking launched two calls for proposals.

On 10 March 2022 the JU launched its first call (HORIZON-ER-JU-2022-01) following the adoption of the JU's Multi-Annual Work Programme²⁷ and Work Programme 2022-2024²⁸ by the Governing Board on 1 March 2022. This call for proposal covered six destinations (Flagship Areas) in accordance with Annex VIII of the WP 2022-2024. It was open to all eligible entities in accordance with the eligibility criteria set out in the Horizon Europe General Annexes, in particular General Annex B²⁹.

The respective Decision of the JU GB approving the results of the call was adopted on 3 August 2022³⁰.

The following tables summarise the amounts and topics related to the call:

Call	Topic	Type of Action	Expected EU contribution per project (EUR million)
HORIZON-ER-JU-2022-01	HORIZON-ER-JU-2022-FA1-TT-01	IA	38.0
HORIZON-ER-JU-2022-01	HORIZON-ER-JU-2022-FA2-01	IA	54.3
HORIZON-ER-JU-2022-01	HORIZON-ER-JU-2022-FA3-01	IA	46.3
HORIZON-ER-JU-2022-01	HORIZON-ER-JU-2022-FA4-01	IA	38.3
HORIZON-ER-JU-2022-01	HORIZON-ER-JU-2022-FA5-01	IA	40.6
HORIZON-ER-JU-2022-01	HORIZON-ER-JU-2022-FA6-01	IA	16.5

Topic Code	Topic Description	Type of Action
HORIZON-ER-JU-2022-FA1-TT-01	Network management planning and control & Mobility Management in a multimodal environment and Digital Enablers	IA
HORIZON-ER-JU-2022-FA2-01	Digital & Automated up to Autonomous Train Operations	IA
HORIZON-ER-JU-2022-FA3-01	Intelligent & Integrated asset management	IA
HORIZON-ER-JU-2022-FA4-01	A sustainable and green rail system	IA
HORIZON-ER-JU-2022-FA5-01	Sustainable Competitive Digital Green Rail Freight Services	IA
HORIZON-ER-JU-2022-FA6-01	Regional rail services / Innovative rail services to revitalise capillary lines	IA

²⁷ https://rail-research.europa.eu/wp-content/uploads/2022/03/EURAIL_MAWP_final.pdf.

²⁸ https://rail-research.europa.eu/wp-content/uploads/2022/03/AWP_2022_2024_Final_Published.pdf

²⁹ https://ec.europa.eu/info/funding-tenders/opportunities/docs/2021-2027/horizon/wp-call/2021-2022/wp-13-general-annexes_horizon-2021-2022_en.pdf.

³⁰ [Decision N°3/2021 of the Governing Board of the S2R JU of 22 June 2021 approving the ranked lists of actions selected for funding, reserve list and the list of rejected proposals under the Shift2Rail JU call for proposals H2020-S2RJU-2021](#)

The total number of proposals received in response to the call for proposals was 7:

Call	Topic	Type of Action	Number of proposals received
HORIZON-ER-JU-2022-01	HORIZON-ER-JU-2022-FA1-TT-01	IA	1
HORIZON-ER-JU-2022-01	HORIZON-ER-JU-2022-FA2-01	IA	1
HORIZON-ER-JU-2022-01	HORIZON-ER-JU-2022-FA3-01	IA	1
HORIZON-ER-JU-2022-01	HORIZON-ER-JU-2022-FA4-01	IA	2
HORIZON-ER-JU-2022-01	HORIZON-ER-JU-2022-FA5-01	IA	1
HORIZON-ER-JU-2022-01	HORIZON-ER-JU-2022-FA6-01	IA	1

A total of 231 participants were involved in the 7 eligible proposals submitted to this call, reflecting respectively on the six topics open to them. Following the evaluation, 201 participants (87%) are involved in the 6 proposals considered for funding.

The total EU-Rail contribution requested by all the submitted proposals amounted to EUR 239,63 million compared to EUR 234 million available for funding:

Call	Type of Action	Grant Requested	Expected EU contribution
HORIZON-ER-JU-2022-01	IA	239.63	234.00

Following the GB Decision N°11/2022 of 3 August 2022, grants were proposed to be awarded resulting in the amounts provided below:

Call	Total Project Cost	EU-Rail Funding	IKOP	Other contribution to R&I
HORIZON-ER-JU-2022-01	425.86	232.76	NA	NA

Following the GAP phase, the value of activities resulting from this call to be performed in the coming period in respect to the signed grants corresponds to EUR 420,6 million of eligible costs, and EUR 583.4 million of total project value, that will be funded by EU-Rail up to EUR 232,5 million.

On 13 September 2022 the JU launched its second call for proposals (HORIZON-ER-JU-2022-02). Since the grants resulting from this call were awarded at a later stage in 2023, the funding figures related thereto will be presented in the 2023 CAAR. However, information pertaining to the evaluation process for this call is provided already in the present report in Section 1.5.

1.4.2. Operational tenders and contracts

With regard to the implementation of procurement activities, the JU has complied with the principles of the EU Financial Regulation and the guidance provided in the European Commission Procurement Vademecum. This resulted in the implementation of activities obtaining the best value for money.

The values established for the different procurement procedures, which are below any materiality level considering the total value of the R&I activities and the Programme, result from the collective knowledge of involved staff and their experience in previous private and public organizations.³¹

In 2022, the JU conducted the following open tender procedure:

³¹ Also in answer to point 15 of Discharge 2016 of EP, reference P8_TA-PROV(2018)0173.

- Europe's Rail System Pillar – framework services contracts for the provision of services to EU-Rail in the fields of System Pillar core group (lot 1), System Pillar expertise (lot 2) and CCS TSI maintenance activities (lot 3) concluded on 12/07/2022 with contractor System Pillar Consortium (for the 3 lots)³². As indicated in the EU-Rail Work Programme 2022-2024, the JU awarded a single framework contract (one per lot) to perform the activities established in the Council Regulation (EU) 2021/2085 for the System Pillar. The framework contracts covered the following services: lot 1 – System Pillar core group - the contractor shall provide expertise with system engineer knowledge developed in rail or other fields, who collectively represent the main stakeholders of the rail sector; lot 2 – System Pillar tasks - the contractor shall provide expertise that the JU will organize in teams to the delivery the work of the System Pillar tasks and horizontal activities; lot 3 – CCS TSI maintenance activities - the contractor shall perform the tasks defined in the request for services that will be issued by the contracting authority to ensure the maintenance of CCS TSI as major area of activities. The awarded total amount is EUR 45,000,000 with EUR 4,000,000 awarded to lot 1, EUR 37,000,000 awarded to lot 2 and EUR 4,000,000 awarded to lot 3.

In 2022 EU-Rail launched a competitive dialogue procedure for the provision of a toolset for Model-Based System Engineering, Conceptual Data Model and Federated Dataspace to the Europe's Rail Joint Undertaking. The competitive dialogue tender procedure was cancelled, as none of the requests to participate submitted by the candidates met the technical and professional capacity (selection criteria) to perform the contract. Therefore, all candidates were rejected and were not invited to the next stage of the procedure (dialogue)³³. EU-Rail will explore the possibilities to launch another tender procedure and/or alternative means to reach the originally planned output.

In accordance with the Work Programme 2022-2024, the implementation of the following framework contracts and of the call for expression of interest continued:

- **“Support to ERTMS European Action Plan to pave the way for the deployment of the future S2R Innovative Solutions”**. The objective of this tender is to ensure the establishment of the essential baseline for the deployment of the future S2R Innovative Solutions through the support to the coherent deployment of European Railway Traffic Management System, a horizontal priority aiming at ensuring the interoperability of the EU railway system. The action is a part of a global project on deployment of ERTMS in the European Union, as defined in the TEN-T Guidelines and the MoU signed between the EC and the European Railway Associations in 2016. The estimated budget for the activities planned for 2022 amounts to EUR 2,900,000 (specific contracts for 2022). This framework contract ended in October 2022 but with the possibility to implement six months after expiry, i.e.: until April 2023. The services under this framework contract will be covered by the new framework contract Europe's Rail System Pillar- lot 3 – CCS TSI maintenance activities above referred.
- **“Railway operators, staff and passengers' expertise” framework contract:**

LOT 1 - Expertise in European railway operations: in 2022, no specific Contract implementing this framework contract was signed.

LOT 2 - Expertise in European railway human capital aspects: in 2022, this framework contract was not renewed and therefore was terminated. The reason is that following the adoption of the SBA and the set-up of EU-Rail, a new structure and activities were established which implement the JU's Programme including human capital aspects. Consequently, EU-Rail does no longer require the services as defined under this framework contract.

LOT 3 - Expertise in European railway passenger aspects: in 2022, no specific contract implementing this framework contract was signed. Call for Expressions of Interest for “Senior external experts to assist the S2R Joint Undertaking with high level support and advice in relation to the R&I activities”. In 2022 no expert contracts were signed due to the lack of available selected experts in the new EU-Rail areas of expertise. In 2022 a new assessment of applications was performed by EU-Rail and 11 new experts were selected.

³² Contract award notice available at the EU OJ n° [2022/S 145-410963](#)

³³ Non-award (cancellation notice) available at EU OJ n° [2022/S 241-695057](#)

In accordance with Article 15 (Principle of transparency) of the EU-Rail Financial Rules the JU shall make available on its internet site no later than 30 June of the following financial year information on the recipients of funds deriving from its budget, including procurement contracts. In addition, as stated in point 3.3 of Annex I to the Financial Regulation 2018/1046 (which applies to the JU), EU-Rail, as a contracting authority, shall publish a list of contracts on its website no later than 30 June of the following financial year for specific contracts and order forms implementing a framework contract. The EU-Rail recipients of Funds and Annual List of Specific Contracts for 2021 are published at <https://rail-research.europa.eu/participate/recipients-shift2rail-funds/>.

1.5. Evaluation procedures and outcomes

EU-Rail launched 2 calls for proposals in 2022.

The evaluation of the first 2022 call for proposals was carried out between 30 June and 15 July 2022. The evaluation procedure was performed remotely, making use of digital web-conferencing tools. However, this represented no issue to the proper performance of the evaluation process.

The evaluation of proposals was carried out with the assistance of 23 independent technical experts and 4 additional experts were also contracted as recorders. Evaluations were conducted in four panels, with the representatives from the Commission (DG MOVE, DG RTD), from ERA and EUSPA having been invited to be present at the panel's meetings as observers. An independent observer was also appointed in accordance with the procedures laid down in the Guide for proposal submission and evaluation of the Horizon Europe grants. The independent observer's role was to observe and offer independent advice on the conduct and fairness of the evaluation sessions, on the application of the evaluation criteria and on ways to improve processes.

In selecting the independent experts, the primary objective was to ensure a high level of skills, experience, and knowledge in the areas of the call (including project management, innovation, exploitation, dissemination and communication). Under these conditions, special attention was given to achieve an appropriate balance composition of the panel in terms of various skills, experience, and knowledge, geographical diversity and gender. The composition was the following:

- Gender balance: 19 men (70%), 8 woman (30%);
- Regional balance: representatives from 14 different countries.

The consensus meetings of the experts were organised remotely during the period 13 – 15 July 2022. A briefing was held on 8 June 2022, in which the EU-Rail representative provided relevant information related to the consensus phase to the independent experts, such as the specificities of the EU-Rail calls for proposals, the confidentiality requirements, or the experts' obligations regarding potential conflicts of interests.

The total number of proposals evaluated was seven, all of them were evaluated. Six proposals were retained for funding representing a success rate of 85,7%.

There were 13 SMEs participating in the call with a success rate of 23%, 3 of them having their proposal retained for funding. Participations of SMEs represented 7,14% within the overall proposals evaluated and 1,97% within the proposals retained for funding.

From a geographical perspective, there were participants to the call coming from 23 countries, there were participants from 19 EU Member States, 3 participants from Associated Countries and one from a third country. Among the 445 participations in proposals retained for funding, 12 EU Member States and 2 Associated Countries are represented.

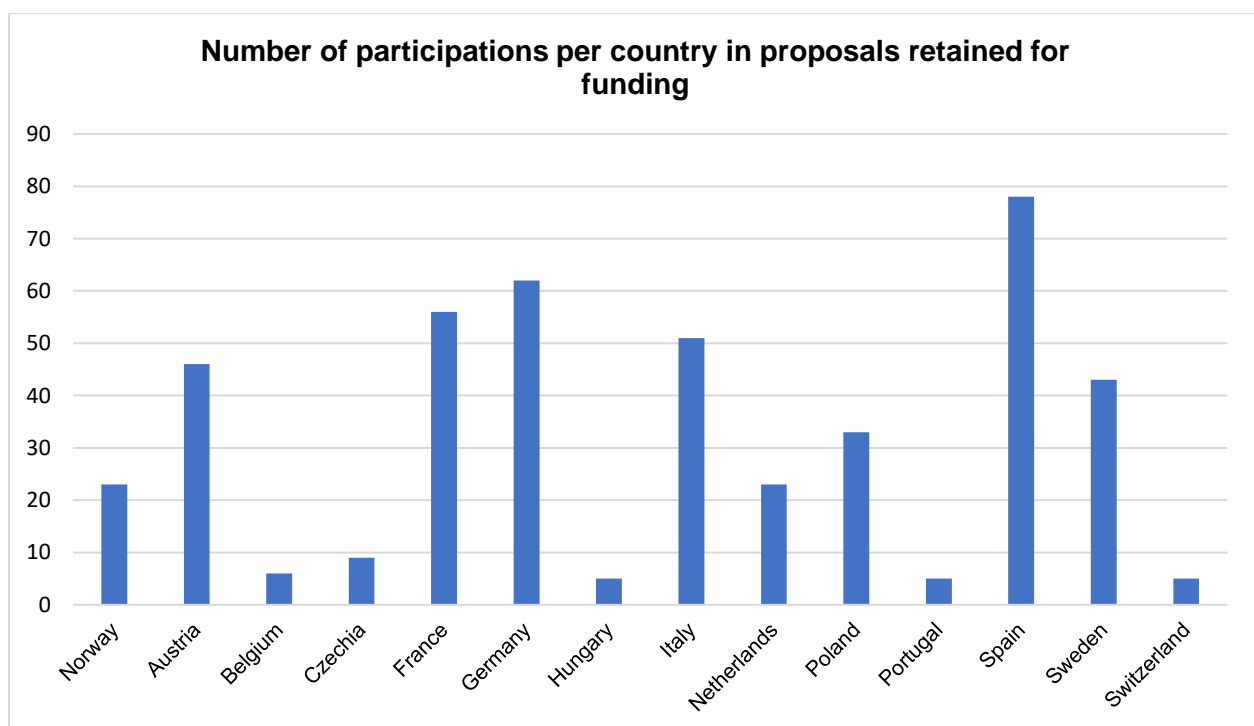
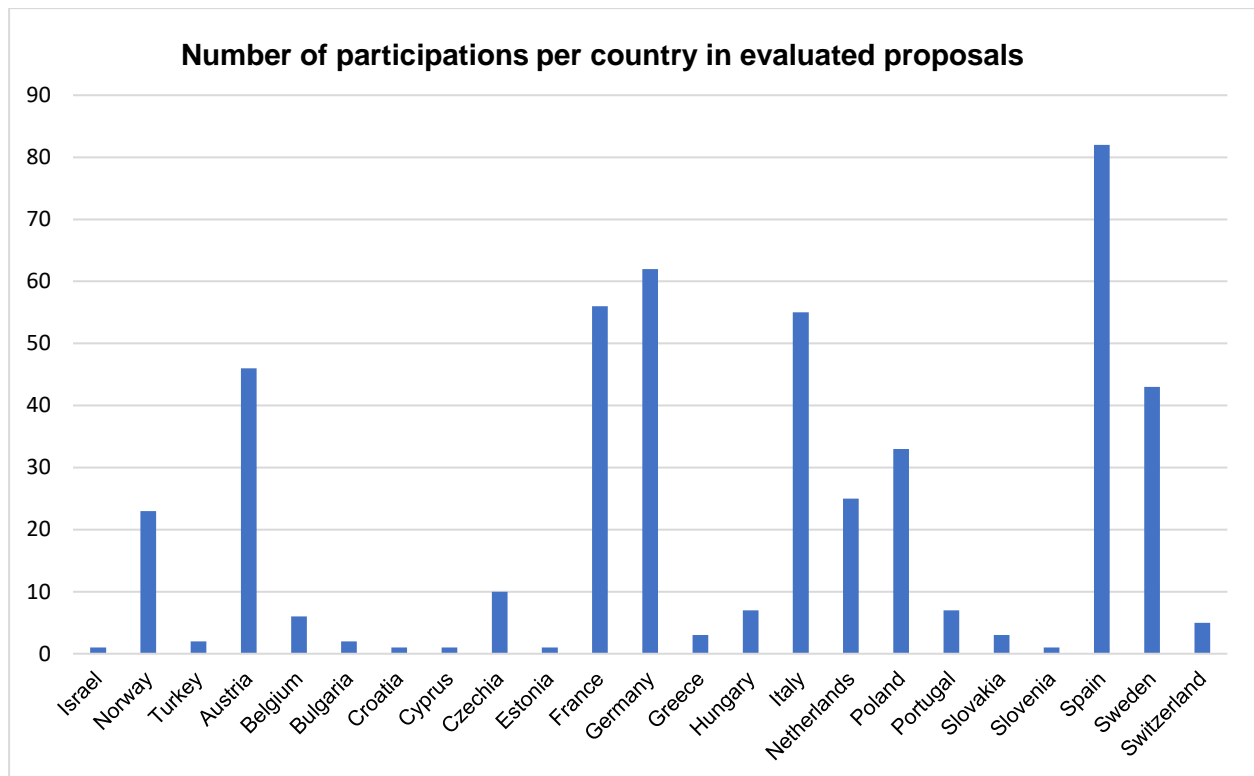

The evaluation of the second 2022 call for proposals was carried out between 16 December 2022 and 31 January 2023. The evaluation procedure was performed remotely, making use of digital web-conferencing tools. However, this represented no issue to the proper performance of the evaluation process.

The evaluation of proposals was carried out with the assistance of 11 independent technical experts, 3 independent financial experts and 3 additional experts were also contracted as recorders. Evaluations were conducted in three panels, with the representatives from the Commission (DG MOVE) and from ERA having been invited to be present at the panel's meetings as observers. One independent observer was also appointed in accordance with the procedures laid down in the Guide for proposal submission and evaluation of the Horizon Europe grants. The independent observer's role was to observe and offer independent

advice on the conduct and fairness of the evaluation sessions, on the application of the evaluation criteria and on ways to improve processes.

The composition of the independent experts selected for the evaluation process was the following:

- Gender balance: 8 men (47%), 9 women (53%);
- Regional balance: representatives from 10 different countries.

The consensus meetings of the experts were organised remotely during the period 26 – 30 January 2023. A briefing was held on 16 December 2022, in which the EU-Rail representative provided relevant information related to the consensus phase to the independent experts, such as the specificities of the EU-Rail calls for proposals, the confidentiality requirements, or the experts' obligations regarding potential conflicts of interests.

The total number of proposals received was sixteen, out of which thirteen passed all thresholds and were evaluated (81,3%). Eight proposals were retained for funding representing a success rate of 61,5%.

There were 31 SMEs participating in the call with a success rate of 54,8%, 17 of them having their proposal retained for funding. Participations of SMEs represented 21,23% within the overall proposals evaluated and 17,35% within the proposals retained for funding.

From a geographical perspective, there were participants to the call coming from 23 countries, there were participants from 17 EU Member States, 4 participants from Associated Countries and 2 from third countries. Among the 98 participations in proposals retained for funding, 16 EU Member States, 3 Associated Countries and 1 third country are represented.

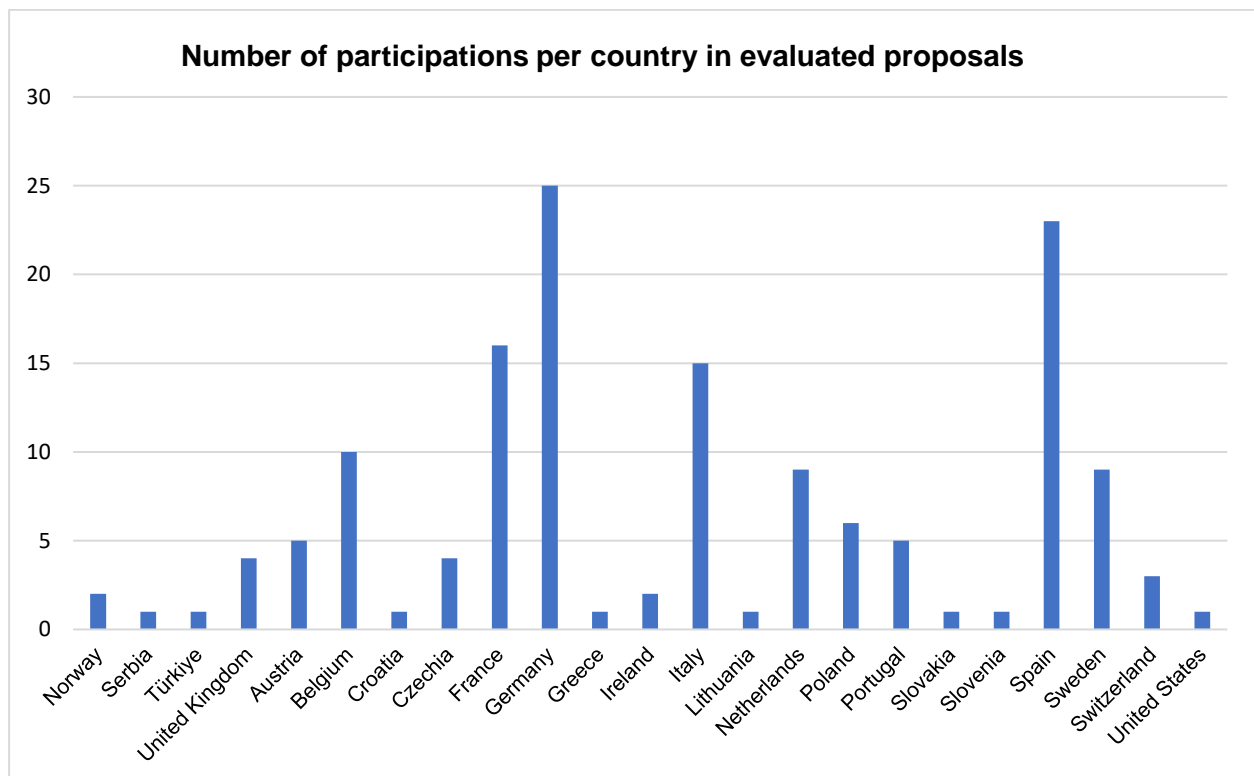

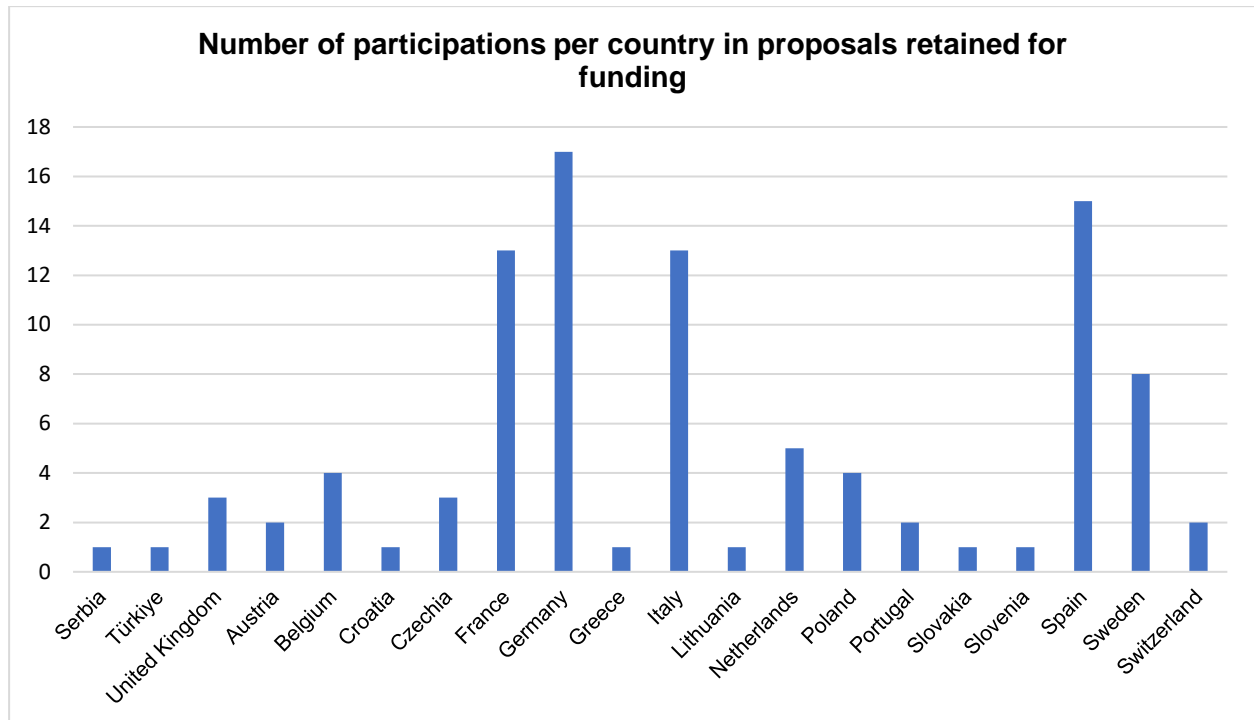

1.6. Follow-up activities linked to past calls

For the Shift2Rail Programme, the year 2022 mainly consisted in ensuring the proper execution of ongoing activities. As by the end of 2021, the JU had signed a total of 101 grant agreements since its autonomy in 2016. The R&I activities performed in the Programme will reach EUR 800 million (including Lighthouse Projects as part of the S2R initiative), of which EUR 650,7 million performed by the S2R Other Members with a funding made available by the JU up to a maximum of EUR 303,3 million.

While in accordance with the respective Membership Agreements the S2R Other Members agreed to limit their request for funding to 44,44% of the Total Project Costs, the OC topics are co-funded at the rates established in the H2020 Rules of participation.

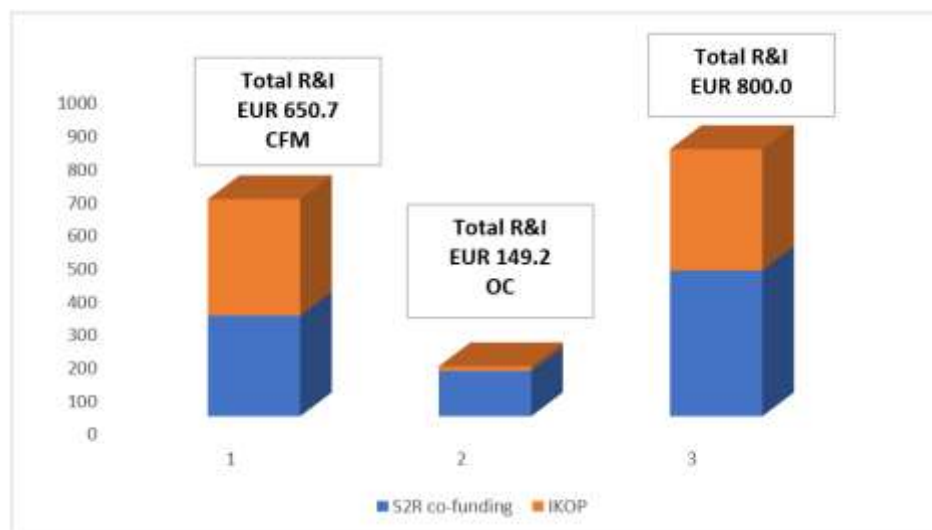

S2R JU R&I running activities all calls included

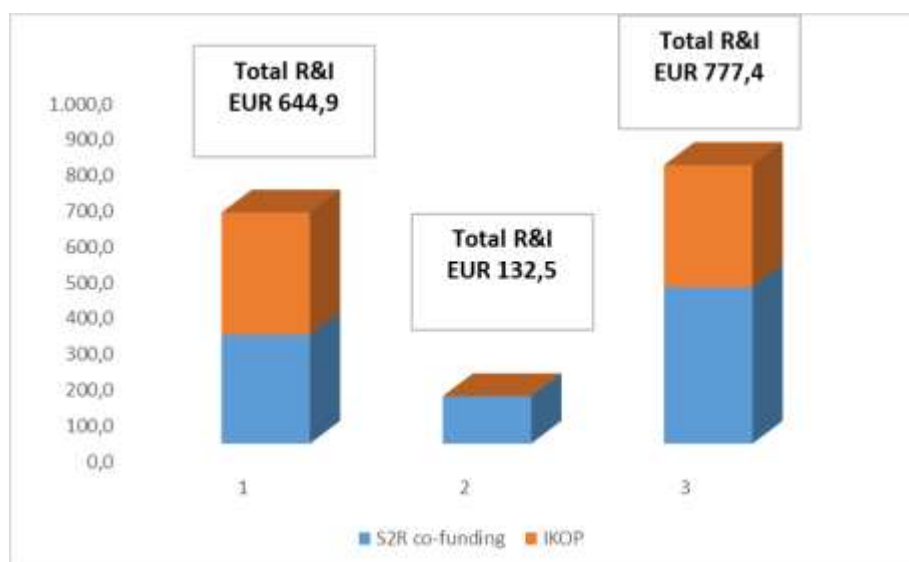

S2R JU R&I activities Programme expected objectives at Programme level

It is therefore important to mention that the S2R R&I activities are expected to exceed the objectives as described in the JU Council Regulations. This will be further confirmed during in 2023 and with the Programme closure in 2024.

On 31 December 2022, taking into consideration activities reaching their completion, 45³⁴ projects were ongoing (24 CFM and 21 OC): 35 projects were distributed on the 5 Innovation Programmes, 6 projects on the Cross Cutting Activities and 4 projects in IPx, as follows:

IP1: Cost-efficient and Reliable Trains, including high-capacity trains and high-speed trains

Project Title	Call Reference	Period ³⁵	Project Value (signed GA)
CARBODIN	S2R-OC-IP1-01-2019	01/12/2019 - 28/02/2022	€ 3 334 368
CONNECTA-3	S2R-CFM-IP1-02-2020	01/12/2020-30/11/2023	€ 8 973 663
GEARBODIES	S2R-OC-IP1-03-2020	01/12/2020-30/16/2023	€ 2 419 969
PINTA-3	S2R-CFM-IP1-01-2020	01/12/2020-31/05/2023	€ 19 446 251
PIVOT2	S2R-CFM-IP1-01-2019	01/10/2019 - 31/03/2023	€ 40 975 405
RECET4Rail	S2R-OC-IP1-01-2020	01/12/2020-31/05/2023	€ 2 300 036
SAFE4RAIL-3	S2R-OC-IP1-02-2020	01/12/2020-31/07/2023	€ 4 585 831

IP2: Advanced Traffic Management & Control System

Project Title	Call Reference	Period	Project Value (signed GA)
4SECURAIL	S2R-OC-IP2-01-2019	01/12/2019 - 01/11/2021	€ 549 875
AB4Rail	S2R-OC-IP2-02-2020	01/01/2021 - 31/12/2022	€ 349 926
OPTIMA	S2R-OC-IP2-02-2019	01/12/2019 - 30/04/2023	€ 2 235 999
PERFORMINGRAIL	S2R-OC-IP2-01-2020	01/12/2020 - 30/06/2023	€ 1 335 359
X2Rail-1	S2R-CFM-IP2-01-2015	01/09/2016 - 30/06/2021	€ 42 905 588
X2Rail-2	S2R-CFM-IP2-01-2017	01/09/2017 - 30/04/2021	€ 28 833 202
X2Rail-4	S2R-CFM-IP2-01-2019	01/12/2019 - 31/12/2023	€ 41 109 700
X2Rail-5	S2R-CFM-IP2-01-2020	01/12/2020 - 31/05/2023	€33 890 375

³⁴ Four Lighthouse projects (2015) not included.

³⁵ When the period end date is before the 31/12/2022, this means that the project was ended but that the final payment was still pending (suspended, technical and financial review ongoing, etc.).

IP3: Cost-efficient, Sustainable and Reliable High-Capacity Infrastructure

Project Title	Call Reference	Period	Project Value (signed GA)
DAYDREAMS	S2R-OC-IP3-02-2020	01/12/2020 - 31/05/2023	€ 1 709 875
IN2SMART2	S2R-CFM-IP3-01-2019	01/12/2019 - 30/11/2022	€ 23 091 203
In2Stempo	S2R-CFM-IP3-01-2017	01/09/2017 - 31/03/2023	€ 13 439 977
In2Track2	S2R-CFM-IP3-01-2018	01/11/2018 - 28/02/2022	€29 676 015
In2Track3	S2R-CFM-IP3-01-2020	12/05/2021- 30/12/2023	€ 27 329 170
IN2ZONE	S2R-OC-IP3-01-2020	01/12/2020 - 31/05/2023	€ 1 349 974
STREAM	S2R-OC-IP3-03-2020	01/12/2020 - 31/05/2023	€ 2 700 000

IP4: It Solution for Attractive Railways Services

Project Title	Call Reference	Period	Project Value (signed GA)
COHESIVE	S2R-CFM-IP4-02-2017	01/09/2017 - 31/12/2022	€ 4 039 492
CONNECTIVE	SR2-CFM-IP4-01-2017	01/09/2017 - 30/06/2023	€ 7 906 243
ExtenSive	S2R-CFM-IP4-01-2020	01/12/2020 - 30/06/2023	€ 11 308 530
IP4MaaS	S2R-OC-IP4-01-2020	01/12/2020 - 30/06/2023	€ 2 507 081
RIDE2RAIL	S2R-OC-IP4-01-2019	01/12/2019 - 30/04/2023	€ 2 999 993

IP5: Technologies for Sustainable & Attractive European Freight

Project Title	Call Reference	Period	Project Value (signed GA)
ARCC	S2R-CFM-IP5-02-2015	01/09/2016 - 30/04/2021	€ 5 346 376
DACcelerate	H2020-S2RJU-2021	01/06/2021 - 31/01/2023	€ 2 171 998
FR8HUB	S2R-CFM-IP5-01-2017	01/09/2017 - 28/02/2021	€ 9 900 990
FR8RAIL II	S2R-CFM-IP5-01-2018	01/05/2018 - 31/12/2022	€ 12 450 390
FR8RAILIII	S2R-CFM-IP5-01-2019	01/09/2019 - 30/06/2023	€ 13 061 601
FR8RailIV	S2R-CFM-IP5-01-2020	01/07/2020 - 30/06/2023	€ 17 604 534
LOCATE	S2R-OC-IP5-01-2019	01/11/2019 - 30/04/2022	€ 1 499 072
SMART2	S2R-OC-IP5-02-2019	01/12/2019 - 30/11/2022	€ 1 708 737

IPX:

Project Title	Call Reference	Period	Project Value
B4CM	S2R-OC-IPX-03-2018	01/12/2018 - 30/11/2022	€ 124 951
LINX4RAIL2	S2R-CFM-IPX-CCA-02-2020	01/12/2020 - 31/05/2023	€ 3 228 829
RAILS	S2R-OC-IPX-01-2019	01/12/2019 - 30/06/2023	€ 299 954
TAURO	S2R-CFM-IPX-01-2020	01/12/2020 - 31/05/2023	€ 4 559 803

CCA: Cross Cutting Activities

Project Title	Call Reference	Period	Project Value (signed GA)
Ben[at]rail	H2020-S2RJU-2021	01/10/2021 - 30/06/2022	€ 169 985
FINE2	S2R-CFM-CCA-01-2019	01/12/2019 - 31/05/2023	€ 8 179 973
IMPACT-2	S2R-CFM-CCA-01-2017	01/09/2017 - 31/12/2022	€ 7 331 848
LINX4RAIL	S2R-CFM-CCA-01-2019	01/12/2019 - 30/11/2022	€ 5 216 494
SILVARSTAR	S2R-OC-CCA-01-2020	01/11/2020 - 28/02/2023	€ 949 999
TRANSIT	S2R-OC-CCA-01-2019	01/12/2019 - 28/02/2023	€ 1 308 718

By 31 December 2022, 56 projects were closed, among which:

Closed Projects related to Call for member topics for S2R JU Members

TOPIC	ACRONYM	TITLE	PROJECT VALUE	GRANT	START DATE	CLOSURE DATE
H2020-S2RJU-CFM-2015-01-1	ATTRACKTIVE	Advanced Travel Companion and Tracking Services	5,4	2,2	01/09/2016	21/10/2020
H2020-S2RJU-CFM-2015-01-1	CO-ACTIVE	Co-modal journey re-accommodation on associated travel services	7,7	3,4	01/09/2016	18/01/2023
H2020-S2RJU-CFM-2016-01-1	CONNECTA	Contributing to Shift2Rail's next generation of high-capable and safe TCMS and brakes, Phase 1.	11,5	5	01/09/2016	25/03/2020
H2020-S2RJU-CFM-2018	CONNECTA-2	Contributing to Shift2Rail's next generation of high-capable and safe TCMS, phase 2.	9,9	4,3	01/10/2018	31/07/2021
H2020-S2RJU-CFM-2015-01-1	FFL4E	Future Freight Loco for Europe	3,5	1,4	01/09/2016	25/03/2020
H2020-S2RJU-CFM-2015-01-1	FINE1	Future Freight Loco for Europe	3,2	1,3	01/09/2016	12/04/2021
H2020-S2RJU-CFM-2015-01-1	FR8RAIL	Development of functional requirements for sustainable and attractive European rail freight	10,9	3,3	01/09/2016	14/12/2021
H2020-S2RJU-CFM-2015-01-1	IMPACT-1	Indicator monitoring for a new railway paradigm in seamlessly integrated cross-modal transport chains – Phase 1	1,2	0,3	01/09/2016	05/07/2021
H2020-S2RJU-CFM-2016-01-1	IN2SMART	Intelligent Innovative Smart Maintenance of Assets by integrated Technologies	15,7	7	01/09/2016	26/04/2021
H2020-S2RJU-CFM-2016-01-1	In2Track	Research into enhanced tracks, switches and structures	5,3	2,3	01/09/2016	03/10/2022
H2020-S2RJU-CFM-2018	MaaSive	Passenger service platform specifications for an enhanced multi-modal transport ecosystem including mobility as a service (MaaS)	9,3	5,1	01/11/2018	18/01/2023
H2020-S2RJU-CFM-2016-01-1	PINTA	IP1 Traction TD1 and Brakes TD5 – Phase 1	28,8	12,6	01/09/2016	14/09/2020
H2020-S2RJU-CFM-2018	PINTA-2	IP1 Traction TD1 and Brakes TD5 – Phase 2	31	12,7	01/09/2018	07/03/2022
H2020-S2RJU-CFM-2017	PIVOT	Performance improvement for vehicles on track	15,4	7,6	01/10/2017	17/03/2021
H2020-S2RJU-CFM-2015-01-1	PLASA	Smart planning and safety for a safer and more robust European railway sector	1,1	0,3	01/09/2016	16/07/2019

TOPIC	ACRONYM	TITLE	PROJECT VALUE	GRANT	START DATE	CLOSURE DATE
H2020-S2RJU-CFM-2018	PLASA-2	Smart Planning and Virtual Certification	1,8	0,8	01/09/2018	21/03/2022
H2020-S2RJU-CFM-2018	X2Rail-3	Advanced Signalling, Automation and Communication System (IP2 and IP5) – Prototyping the future by means of capacity increase, autonomy and flexible communication	33,8	17,2	01/12/2018	21/02/2023

Closed Projects related to Open call topics for S2R JU non-Members

TOPIC	ACRONYM	TITLE	PROJECT VALUE	GRANT	START DATE	CLOSURE DATE
H2020-S2RJU-OC-2018	ASSETS4RAIL	Measuring, monitoring and data handling for railway assets; bridges, tunnels, tracks and safety systems	5,5	4,5	01/12/2018	09/03/2023
H2020-S2RJU-OC-2017	ASTrail	Satellite-based signalling and automation systems on railways along with formal method and moving block validation	1,8	1,8	01/09/2017	29/04/2020
S2R-OC-IP2-01-2015	CYRAIL	Cybersecurity in the railway sector	1,5	1,5	01/10/2016	28/01/2020
S2R-OC-CCA-03-2015	DESTINATE	Decision supporting tools for implementation of cost-efficient railway noise abatement measures	1,0	1,0	01/11/2016	14/08/2019
S2R-OC-IP5-02-2015	DynaFreight	Innovative technical solutions for improved train dynamics and operation of longer freight trains	0,9	0,9	01/11/2016	24/01/2019
H2020-S2RJU-OC-2018	EMULRADIO4RAIL	Emulation of radio access technologies for railway communications	0,7	0,7	01/12/2018	26/11/2021
H2020-S2RJU-OC-2017	ETALON	Energy harvesting for signalling and communication systems	1,7	1,7	01/09/2017	09/12/2020
H2020-S2RJU-OC-2017	FAIR Stations	Future Secure and Accessible Rail Stations	1,2	1,2	01/09/2017	10/02/2021
H2020-S2RJU-OC-2018	FLEX-RAIL	Paradigm shifts for railway – Technology uptake strategies for a lean, integrated and flexible railway system	1	1	01/12/2018	14/12/2021
H2020-S2RJU-OC-2019	FUNDRES	Future unified DC railway electrification system	0,7	0,7	01/12/2019	03/10/2022
H2020-S2RJU-OC-2018	GATE4RAIL	GNSS Automated virtualized test environment for rail	1	1	01/12/2018	07/02/2022
S2R-OC-IP4-01-2016	GoF4R	Governance of the Interoperability	1,8	1,8	01/11/2016	08/11/2019

TOPIC	ACRONYM	TITLE	PROJECT VALUE	GRANT	START DATE	CLOSURE DATE
		Framework for Rail and Intermodal Mobility				
H2020-S2RJU-OC-2015-01-2	GoSAFE RAIL	GoSAFE RAIL- Global Safety Management Framework for Rail Operations	1,3	1,3	01/10/2016	24/07/2020
H2020-S2RJU-OC-2020	HYPERNEX	Hypernex: Ignition of the European Hyperloop Ecosystem	0,3	0,3	01/12/2020	24/07/2020
H2020-S2RJU-OC-2017	IN2DREAMS	Intelligent solutions towards the development of railway energy and asset management systems in Europe	2,1	2,1	01/09/2017	21/02/2023
H2020-S2RJU-OC-2015-01-2	INNOWAG	Innovative monitoring and predictive maintenance solutions on lightweight wagon	1,4	1,4	01/11/2016	03/08/2020
H2020-S2RJU-OC-2018	M2O	Make rail the hope for protecting nature to future operation	0,6	0,6	01/12/2018	16/06/2021
H2020-S2RJU-OC-2017	Mat4Rail	Designing the railway of the future: Fire resistant composite materials and smart modular design	3,5	3,5	01/10/2017	06/06/2020
S2R-OC-IP2-03-2015	MISTRAL	Communication systems for next-generation railways	0,5	0,5	01/11/2016	08/08/2019
H2020-S2RJU-OC-2017	MOMIT	Multi-scale observation and monitoring of railway infrastructure threats	0,6	0,6	01/09/2017	27/10/2020
H2020-S2RJU-OC-2018	MOVINGRAIL	Moving block and virtual coupling new generations of rail signalling	1,2	1,2	01/12/2018	28/06/2021
H2020-S2RJU-OC-2018	MVDC-ERS	Flexible medium voltage DC electric railway systems	0,1	0,1	01/12/2018	12/03/2023
H2020-S2RJU-OC-2017	My-TRAC	My-TRAC	3,5	3,5	01/09/2017	03/11/2021
S2R-OC-CCA-01-2015	NEAR2050	NEAR2050 - future challenges for the rail sector	0,4	0,4	01/10/2016	18/10/2019
H2020-S2RJU-OC-2019	NEXTGEAR	NEXT generation methods, concepts and solutions for the design of robust and sustainable running GEAR	2,6	2,6	01/12/2019	21/02/2023
H2020-S2RJU-OC-2015-01-2	OPEUS	Modelling and strategies for the assessment and optimisation of energy usage aspects of rail innovation	0,7	0,7	01/11/2016	08/09/2020
H2020-S2RJU-OC-2017	OPTIYARD	Optimised real-time yard and network management	1,4	1,4	01/10/2017	09/12/2020
H2020-S2RJU-OC-2017	RUN2Rail	Innovative running gear solutions for new dependable,	2,5	2,5	01/09/2017	03/08/2020

TOPIC	ACRONYM	TITLE	PROJECT VALUE	GRANT	START DATE	CLOSURE DATE
		sustainable, intelligent and comfortable rail vehicles				
H2020-S2RJU-OC-2016-01-2	SAFE4RAIL	Safe architecture for robust distributed application integration in rolling stock	6,7	6,7	01/10/2016	15/07/2020
H2020-S2RJU-OC-2018	SAFE4RAIL-2	Smart Planning and Virtual Certification	4	4	01/10/2018	04/04/2022
H2020-S2RJU-OC-2016-01-2	S-CODE	Switch and Crossing Optimal Design and Evaluation	4,4	4,4	01/11/2016	28/11/2021
H2020-S2RJU-OC-2018	SHIFT2MAAS	Shift2Rail IP4 enabling mobility as a service and seamless passenger experience	1,4	1,4	01/12/2018	16/01/2022
H2020-S2RJU-OC-2015-01-2	SMART	Smart Automation of Rail Transport	1,0	1,0	01/10/2016	02/02/2021
H2020-S2RJU-OC-2017	SMaRTE	Smart Maintenance and the Rail Traveller Experience	0,7	0,7	01/09/2016	02/07/2020
H2020-S2RJU-OC-2018	SPRINT	Semantics for performant and scalable interoperability of multimodal Transport – SPRINT	2	2	01/12/2018	21/10/2021
S2R-OC-IP4-02-2016	ST4RT	Semantic Transformations for Rail Transportation	1,0	1,0	01/11/2016	21/06/2019
H2020-S2RJU-OC-2018	TER4RAIL	Transversal Exploratory Research Activities for Railway	0,5	0,5	01/12/2018	28/05/2021
H2020-S2RJU-OC-2019	Translate4Rail	Translation for breaking language barriers in the railway field	0,2	0,2	01/12/2019	09/08/2022
H2020-S2RJU-OC-2015-01-2	VITE	Virtualisation of the testing environment	0,9	0,9	01/11/2016	22/06/2020

1.7. Openness, cooperation, synergies and cross-cutting themes and activities

In terms of national funded R&I activities in the Railway sector, the JU invites the relevant Member States to present their programmes and projects in the context of the meetings of the SRG. This allows discussion on ways to interconnect the different activities and ensure that resources are leveraged to achieve the best results. This is an ongoing process, which becomes increasingly relevant in view of standardisation processes and market uptake.

During 2022, the ongoing work on collaboration agreements, in the form of a Memorandum of Understanding (MoU) or cooperation agreement, which the JU may sign with various European regions and Member States, European and international organizations and bodies was pursued. A new MoU has been initiated in 2022 with Rail Net Europe, in view of the new mandate of the JU related to the System Pillar activities as well as the upcoming R&I work on Traffic management. Relevant updates of previous MoU – to reflect the new specificities of the EU-Rail Programme – was initiated, in particular with UIC to ensure appropriate integration of the FRMCS specifications within the rail system architecture defined under the System Pillar and to reinforce the EU-Rail Programme overview on the developments for telecommunications and localization.

During the French Presidency of the Council of the European Union and against the backdrop of the Connecting Europe Days a Memorandum of Understanding between the Community of European Railway and Infrastructure Companies (CER), the Alliance of Passenger Rail New Entrants in Europe (ALLRAIL),

the European Rail Supply Industry (UNIFE) and the Europe's Rail Joint Undertaking was signed. The objective of the Memorandum of Understanding is a study on 'Smart and Affordable High-Speed Services in the European Union'. The study aimed to demonstrate the most significant benefits deriving from the completion of a European high-speed rail network connecting the capitals and major cities of Europe, as well as the clear sustainability merits. The study also aims at fostering a radical transformation of the rail system and delivering on European Green Deal objectives, including the achievement of a fully operational, multimodal, sustainable, and smart Trans European Transport Network (TEN-T), with high-speed rail connectivity by 2050.

In addition, the JU also further explored synergies with other JUs and partnerships.

The collaboration with the Fuel Cell and Hydrogen (FCH) Joint Undertaking started in 2018, with the co-tendering of a Study on the use of Fuel Cells and Hydrogen in the Railway Environment. This resulted in three reports being jointly presented and published on the respective websites³⁶. This collaboration sets the basis for the future alignment of the respective programmes in view of the hybridization of rail systems making use of the FCH technologies. The cooperation is now continuing under Clean Hydrogen JU, the following can be reported:

- The FCH funded project FCH2Rail³⁷ is liaising with S2R Project PINTA3, which touches upon the topic on roadmap for Carbon free mobility. FCH2Rail is delivering train demonstrator tests carried out cross-border in Portugal and Spain, seeking for authorisation for three EU countries.
- Active exchanges for future programmes design and synergies, respectively for Europe's Rail and Clean Hydrogen, happened all along 2021 and 2022. Resulting with four topics of the Call launched by Clean Hydrogen where the expected outputs could constitute inputs for rail demonstrations
 - HORIZON-JTI-CLEANH2-2022-02-10: Implementing new/optimised refuelling protocols and components for high flow HRS; HORIZON-JTI-CLEANH2-2022-03-05: [Large scale demonstration of hydrogen fuel cell propelled inland waterway vessels](#); HORIZON-JTI-CLEANH2-2022-03-03: [Large scale demonstration of European H2 Heavy Duty Vehicle along the TEN-T corridors](#); and, HORIZON-JTI-CLEANH2-2022-02-11: [Development and demonstration of mobile and stationary compressed hydrogen refuelling solutions for application in inland shipping and short-distance maritime operations](#).
- In order to ensure as much as possible the future synergies, EU-Rail has inserted in the EU-Rail Call text for the topic Destination 4 "A sustainable and green rail system" that the future funded action shall foresee a common activity/task related to the capturing of specific requirements stemming from the action to be funded within the Clean Hydrogen JU, in relation to hydrogen solutions, and the partnership BATT4EU concerning batteries".

Additionally, the JU conducted several exchanges with the new PPP on batteries Batt4EU, looking for priorities alignments and synergies across programme, in particular with Europe's Rail. The following can be reported:

- S2R /Europe's Rail JU contributed, through its project PINTA3, to the KPIs/needs related to the energy traction in rail (published by the European Commission in the document "Roadmap on Mobile application of batteries).
- In the European Commission call related to BATT4EU a specific topic has been identified in which the rail needs in term of next-generation battery can be addressed (HORIZON-CL5-20222-D2-01-05), TRL5 expected by the end of the project.
 - See section 4 and appendixes, https://energy.ec.europa.eu/roadmap-application-and-integration-mobile_en.
 - [Next generation technologies for High-performance and safe-by-design battery systems for transport and mobile applications](#).

The JU enhanced its collaboration with the Space and aviation sector. The following can be reported:

- IP2 which contains a Technological Demonstrator on Safe Train Positioning (TD 2.4) has collaborated with the EU Agency for the Space Programme (EUSPA) as regards the introduction of GNSS for train positioning. The EUSPA-financed CLUG project³⁸ (Certifiable Localisation Unit with GNSS in the Railway Environment) is also expected to provide a key building block to the

³⁶ <https://shift2rail.org/publications/study-on-the-use-of-fuel-cells-and-hydrogen-in-the-railway-environment/>

³⁷ <https://verkehrsforschung.dlr.de/en/projects/fch2rail>

³⁸ <http://www.clugproject.eu/en>

overall work to be achieved within the S2R programme TD2.4 (and to be completed in the EU-RAIL programme under Flagship Area 2 “Digital and Automated up to Autonomous train operations”).

- A close cooperation with the sector has also been launched to work on relevant standardization topics, such as Digital Maps and GNSS Augmentation, both key component for the localization function. On this specific point, collaboration with the European Space Agency (ESA) has also been launched.
- Further alignment work with SESAR JU on matters related to multimodal mobility passenger solutions (as MaaS) through its projects related to the S2R innovation Programme 4, as well as related to traffic management and functional system architecture, inviting the experts to present their approaches in the S2R projects Linx4Rail 1 and 2 which aim to create an innovative rail functional system architecture. This output will feed the new EU-Rail Programme and in particular the System Pillar works.

In the domain of Cybersecurity for rail, EU-Rail continued the collaboration in the field of Cyber Security for Railways (ER-ISAC)³⁹. Cooperation is covering aspects related to sharing best practices (e.g. product security verification, penetration testing, system verification and validation requirements in IEC standards) or also regarding the early analysis of the feasibility to establish a railway CSIRT (Computer Security Incident Response Team) at European level.

Similarly, initial talks were initiated in 2021 with EuroHPC JU in order to look for possible services offered when in the course of the new programme significant computing capabilities would be needed (e.g. for traffic management prediction at European scale). This is something which has started to be looked at in the frame of FP1 for “Network management, planning and control & mobility management in a multimodal environment and digital enablers”.

The JU continued also its participation to the Digital PRIME working group, promoted by the European Commission together with rail infrastructure managers around traffic planning/management improvements mainly.

In terms of synergies with other Union Programmes, the JU works closely with the other Joint Undertakings sharing the same building, infrastructure, etc. maximising the opportunity for collaboration in terms of administrative and operational activities.

Beyond the operational activities, 2022 saw the preparation, design and implementation of Article 13 SBA, where EU-Rail took over the responsibility for the coordination of the Back Office Arrangement (BOA) – Accounting Services. Other three BOAs were established under the leadership of other JUs with EU-Rail taking up an active supporting role in those as well. For more information about administrative synergies among JUs, please refer to the section 2.7.2 “Efficiency gains and synergies”, of the present document.

1.8. Progress against KPIs

1.8.1. H2020 KPIs

The H2020 Key performance Indicator results for the year 2022 are presented in Annex E. The JU has taken into its scoreboard all Horizon 2020 indicators, which have been established for the entire Research family by the Commission, to the extent they can be applied to the JU in view of providing meaningful results.

Comments to some indicators are provided in the tables in Annex E or in the related section of this CAAR, to which the indicators refer.

Within the context of the CCA activities, during 2022 the JU continued the work to maintain the ‘S2R 2030 Impact Forecast Model’ ensuring the next Release, resulting from the update of the data input from the different projects and TDs. The latest figures (Release 5) are provided in Annex E Table IV of the present CAAR. The KPI tool is fully available to the public on the EU-Rail website (<https://kpi.shift2rail.org/Dashboards/Dashboard/41>)

³⁹ <https://er.isacs.eu/>

1.8.2. Progress against General HE KPIs

The HE Key Performance Indicator results for the year 2022 are presented in Annex F. Given that the programme only started with projects at the end of 2022, several indicators cannot be reported for 2022.

1.8.3. Progress against HE Common JUs KPIs

The HE Key Performance Indicator results for the year 2022 are presented in Annex F. Given that the programme only started with projects at the end of 2022, several indicators cannot be reported for 2022.

1.8.4. Progress against JU-specific KPIs

The EU-Rail specific Key Performance Indicator results for the year 2022 are presented in Annex F. Given that the programme only started with projects at the end of 2022, several indicators cannot be reported for 2022.

1.9. Dissemination and information about project results

The JU disseminates the project results at the heart of its R&I programme. Dissemination activities mainly target the European scientific and academic community working in the mobility field, and specifically rail, but not exclusively. Dissemination therefore plays an essential role within the EU-Rail Programme, being a core ingredient of its success. In 2022 many in-person communication and dissemination activities resumed after having been postponed due to the Covid-19 pandemic. Namely, InnoTrans, Transport Research Arena and the World Congress on Railway Research were an opportunity to bring S2R innovations and present the Europe's Rail programme to the railway, transport and research industries, as well as decision and policy makers.

All JU dissemination activities are designed to consolidate the JU as the key European platform for R&I in the railway sector, with the new System Pillar bringing the sector together, where all interested parties, including manufacturers, infrastructure managers, rail operators, regulators, research centres, SMEs and other stakeholders can exchange to ensure rail becomes the everyday mobility in Europe. The JU website hosts Shift2Rail and Europe's Rail projects' websites and dissemination activities (See also section 2.1).

Dissemination of project results was a prominent element of various EU-Rail and external events during 2022, especially during InnoTrans (20-23 September), Transport Research Arena (TRA) (14-17 November) and the annual Europe's Rail Innovation Days (7-9 December).

InnoTrans took place on 20-23 September in Berlin and was the key flagship event with Europe's Rail participation in 2022. Europe's Rail had a 105sqm stand which hosted a plethora of innovations coming from the Shift2Rail programme, covering all Innovation Programmes (IPs). In total 20 different innovative solutions were available on the Europe's Rail stand which served as a hub for the Founding Members and partners. A particular emphasis can be placed on two live demonstrations that took place during the event, presented to the European Commissioner for Transport, the Director General for Mobility and Transport, CEOs of Europe's Rail Founding Members, partners and press and media. Namely, the demonstration of an automatic train operations from the Czech Republic and the demonstration of a cross border translation tool from Italy took place and gathered strong interest from the audience. Additionally, a dedicated panel discussion attended by more than 150 participants was organised to inform the rail sector on the latest activities regarding the digital automatic coupler and how the S2R IP5 projects and the European DAC Delivery Programme, enabled by Europe's Rail, have facilitated its development. Other key solutions showcased on the stand, were the Travel Companion application demonstrating booking and ticketing solutions, virtual reality tool on noise abatement, exoskeleton for back support, digital automatic coupler, lightweight seats, new composite material wagon panels, and bogie mock-up among others.

Another event with Europe's Rail participation disseminating results from the Programme was Transport Research Arena (TRA), which took place on 14-17 November in Lisbon. During the event a series of demonstrations took place on the Europe's Rail corporate stand, notably presenting a virtual reality tool of digital automatic coupling (DAC), a virtual reality tool on noise abatement, the Travel Companion application showcasing booking and ticketing solutions, and the cross-border translation tool. Europe's Rail also supported and promoted the mid-term event of the Extensive project.

The S2R Innovation Days were conceived as a platform to promote JU results and to bring the sector together to discuss progress and future plans. The event was also considered a successful way of attracting a larger audience for the dissemination of the results of projects rather than the small-scale individual final events of projects which to date have gained little attention from participants outside of the organisations involved in the projects. During the S2R Innovation Days, the results of more than 15 projects were discussed in dedicated webinars. In 2022 no high-level panels took place during the Innovation Days, due to the large number of external events organised by the JU.

Moreover, project results were also presented and discussed at a number of other external events where JU staff, Founding Members and project partners participated. More details on these events are available in Section 2.1.1.

2022 also saw an increased use of shared dissemination information among projects coordinated by the JU Communication Team. Throughout 2022 [the webpage on Project Results](#) launched in 2021 in collaboration with the JU Programme Unit was a key communication and dissemination priority. Each month a number of selected results and deliverables coming from Shift2Rail projects are highlighted in this section of the website to ensure continuous communication about their achieved progress. The webpage includes a short description of each deliverable, giving a brief of account on how it brings us closer to achieving better rail for Europe. This approach has resulted in a multiplier effect as we have used this content for further promotion on our corporate social media channels and newsletter.

In 2022 we also continued to populate the section in the JU newsletter specifically dedicated to project news. This section benefits from an increased click-through rate from our viewers. A section dedicated to EU-Rail projects was developed in 2022 to ensure the readers are up to date with the latest developments coming from the new Flagship Projects. Additionally, in 2022, EU-Rail has continued to promote projects final and mid-term conferences on social media channels, news section of the JU website and newsletter. The cross-projects collaboration of communication activities pushed by the JU, has allowed for a more efficient promotion of this increased activity and a global overview of all project dissemination, ensuring we are able to promote results in a timely and effective manner. It also has enabled monitoring and the possibility to advise projects in the dissemination of their work in order to ensure they support the programme approach and contribute to the overarching JU communication strategy.

In 2022, EU-Rail developed a set of communication and dissemination guidelines specifically targeted towards the new Europe's Rail projects. The guidelines provide information and best practice on how to develop a successful and thorough communication and dissemination strategy, provides a timeline for implementations and explains how EU-Rail can support in disseminating their news and results.

In terms of publications, the 2022 Edition of the Europe's Rail Catalogue of Solutions was produced and launched during InnoTrans. The publication summarises key innovations and solutions developed within the Shift2Rail programme, with a view to market deployment.

Project Final Conferences in 2022:

- 14 December – PINTA3 Final Conference, Brussels, Belgium
- 9 December – FR8RAIL III Final Conference, Online
- 9 November – IN2SMART Final Conference, Milan, Italy
- 8 November – SMART2 Final Conference, Niš, Serbia
- 28 September – In2Stempo Final Conference, Online
- 14 June – Ben@Rail and IMPACT-2 Final Conference, Brussels and Online
- 23 February – HYPERNEX Final Conference, Online
- 17 February – NEXTGEAR Final Conference, Online
- 18 January – FUNDRES Final Conference, Online

2. SUPPORT TO OPERATIONS

2.1. Communication activities

The JU continued to promote the activities of the Programme during 2022. The JU communication activities in 2022 were focused on the continued promotion of the S2R Programme, and bringing as much visibility as possible to the results of its R&I activities, while also raising awareness of the new Europe's Rail Programme, its mission and vision, its Calls for Proposals and the new System and Innovation Pillars. The first General Assembly⁴⁰ of EU-Rail was organized on 30 November 2022, supporting the operational activities of the JU and gathering all participants to the research and innovation activities of the Europe's Rail Joint Undertaking in accordance with Article 93(5) of the Single Basic Act. The primary objective of the assembly was to stimulate reflection on the overall direction of the activities of the Europe's Rail Joint Undertaking, while conducting an open and transparent discussion on the progress of the Master Plan implementation.

Most communication activities in 2022 revolved around organisation and participation to events, as well as developing the new Europe's Rail brand guidelines and recognisability. In January 2022 an internal request to the members was launched to develop the new Europe's Rail JU logo using their own resources. All Founding Members were invited to participate and in total six different submissions were received. The winning logo was selected through a dedicated voting by Founding Members, and the JU staff.

The new logo was revealed during the Europe's Rail Launch Ceremony on 21 February, organised against the backdrop of the Informal Ministerial Summit during the French Presidency of the Council of the European Union. Subsequent visual identity guidelines, based on the logo, were developed in Q2. The new logo and the new visual identity guidelines were applied to all corporate communication channels, materials and templates and shared with Founding Members and Projects for corporate use.

Promotion of the 2022 Calls for Proposals was as usually a focus of the yearly communication activities. In 2022 two Calls for Proposals were launched and widely promoted through website, newsletter, social media channels and through events and this promotional content was successfully re-shared by EU-Rail Founding Members and partners as well as reported in the press (see Annex C).

In 2022, the JU Communications successfully organised two meetings with the Communication Officers of Founding Members' companies to align the key priorities and communication expectations, as well as agree on best practices on information exchange. The meetings were used as an opportunity to involve Founding Members in events organised by the JU. These meetings have deemed successful as Founding Members have placed a much stronger emphasis in incorporating communication about Europe's Rail in their Corporate Communication Strategies and Action Plans.

In parallel to the key events organised and participated in by the JU during 2022 (see Annex C), the JU continued to build its audience and continued to improve its stakeholder mailing list in order to ensure that news are reaching the correct audiences. For instance, the Founding Members corporate Communication Officers mailing list was fully reviewed and updated. In addition, with EU-Rail's increased presence as a key actor in rail, new stakeholders in other areas of interest (climate, growth, other transport areas) are increasingly reaching out to the JU.

Europe's Rail participated to the Connecting Europe Days under the French Presidency and organised by DG MOVE and CINEA. Furthermore, relations with Commission en Direct were strengthened during 2022 through a number of articles produced. It is also worth mentioning that the network with the Communication Officers of the other Joint Undertakings was utilised too in 2022 to ensure coherent information exchange, as well as regular exchanges with HCIN.

Relations with the European Parliament are regular and the JU's expertise is searched to contribute to a number of working activities from the TRAN Committee in particular.

⁴⁰ <https://rail-research.europa.eu/about-europes-rail/europes-rail-structure-of-governance/europes-rail-governing-board/general-assembly/>

Furthermore, press relations in 2022 were also strengthened, increasing media presence not just in specialised rail press (particularly in the Railway Gazette, International Railway Journal, Global Railway Review, and Railway Pro – all press articles are listed in Annex C), but also in more mainstream press outlets, such as CNN. In 2022, the JU continued to implement ongoing media partnerships with Railway Gazette, BtoB Magazine and signed a new partnership with the Energy Innovation Magazine. The JU also had a collaboration agreement with Rail Live and World Passenger Festival organisers.

Within the frame of the European Year of Youth, the JU continued to build relationships with students and start-ups. For instance, Europe's Rail supported the TRA Visions Young Scientists Competition, invited ERRAC Student Competition and Hack2Rail hackathon winners to InnoTrans. Furthermore, the JU supported the European Startup Prize for Mobility held under the auspices of the Chair of the European Parliament's Transport Committee. In addition, Europe's Rail supported the Women in Rail initiative launched by the European Commission, UNIFE and CER and sponsored the winners' participation to InnoTrans.

The JU continued revamping its website based on the new visual identity guidelines by introducing new features, sections and improving user friendliness, as well as increasing its presence on social media, which resulted in a major follower growth on LinkedIn. The overall impressions reached on Europe's Rail LinkedIn channel was 700k, compared to only 440k in 2021, showcasing that there is strong interest to follow content produced by the JU. Moreover, the JU has also increased its presence on its YouTube channel. Efforts have been made to publish videos showing our innovations as well as recordings of our online events to ensure that even those who were unable to join can access the content. New webpages about Europe's Rail, including a dedicated section on the System Pillar was introduced, compiling all relevant information and documentation about the new Programme.

During 2022, the JU published: The [2022 Edition of the Catalogue of Solutions](#), the [Annual Activity Report 2021](#) and the [EU-Rail Factsheet](#), incorporating the new visual identity. All three publications were promoted during various events in presence, most prominently, at InnoTrans, TRA, Rail Live.

The JU participated to nearly 80 different events across Europe and beyond, strongly showcasing the Partnership's importance within the rail and transport communities globally. One example is Europe's Rail participation to the World Congress on Railway Research. Europe's Rail participated with a 64sqm stand, showcasing various demonstrations developed in the Shift2Rail Programme. A full list of events organised and participated in by the JU to ensure stakeholder engagement is available in section 2.1.1. and Annex C of this CAAR.

A close collaboration with the European Union Agency for Railways (ERA) in different areas, with the European Railway Research Advisory Council (ERRAC), as well as with the different International and European organizations and associations. A continuous and constructive exchange took place with other Union bodies and agencies. In terms of collaboration for instance, Europe's Rail hosted ERRAC on its stands during WCRR, InnoTrans and TRA.

In 2022, journalists have also been targeted by the JU on social media which has proved effective as well. The fact that the Programme continues to become better known and the interest in its results progressively increases is reflected in a broader media coverage of EU-Rail compared to previous years.

Communication statistics can also be found in Annex C.

Data protection

In cooperation with the ICT Officer, the Chief Legal Officer, who also acts as the JU's Data Protection Officer, and two contractors managing the rail-research.europa.eu and projects.shift2rail.org domains, EU-Rail Communication team continued to work on making the website compliant with the data protection regulation based on the instructions provided by the European Data Protection Supervisor. It was ensured that the website platform and applications are compliant with the GDPR and EUDPR Regulations. In particular, our contractor ensured that a privacy management platform is used. Furthermore, the website cookie management was improved. All passwords were encrypted and a more secure method with unique hashed key and frequent backup was developed. A backup content database that is not on the same server as the website was created.

Cookie Notice & Compliance for GDPR / CCPA plugin which was supposed to handle the cookie compliance of the website was removed as this task is already handled by the *Complianz – GDPR/CCPA Cookie Consent plugin*. The active cookie handling plugin was updated and verified that cookies are indeed being blocked when users do not accept them. Additionally, the *MailChimp* plugin was supposed to link newsletter signup forms on the website with the MailChimp account. However, the newsletter signup forms on the website used another method for sending information to the EU-RAIL *MailChimp* account. The *MailChimp* plugin was therefore deactivated and removed.

As a result of this work, JU's website is considered compliant with the data protection regulation that also helped the domain to substantially improve its position in the EU Privacy Score Tool.

2.2. Legal and financial framework

In accordance with Council Regulation (EU) 2021/2085 (the "SBA"), EU-Rail is the legal and universal successor of the S2R JU, which it replaced and succeeded as from 30 November 2021.

To ensure the business continuity of the operations, in the first Governing Board meeting of EU-Rail a list was approved containing Decisions⁴¹ adopted still under the S2R JU which continue to apply for EU-Rail in accordance with Article 174(12) of the SBA. This list includes Decisions concerning aspects related to governance, human resources, finance, audit and internal controls and compliance, and in particular the Financial Rules of the JU. The Executive Director also approved the list of ED Decisions adopted under the S2R Ju that will continue to apply to EU-Rail.

Thus, any references to S2R JU in the internal legal framework shall be construed as references to EU-Rail.

In 2022, the EU-Rail legal framework refers predominantly to:

- Treaty on the Functioning of the European Union (TFEU), and in particular Article 187 and the first subparagraph of Article 188 thereof.
- Council Regulation (EU) 2021/2085 of 19 November 2021 establishing the Joint Undertakings under Horizon Europe and repealing Regulations (EC) No 219/2007, (EU) No 557/2014, (EU) No 558/2014, (EU) No 559/2014, (EU) No 560/2014, (EU) No 561/2014 and (EU) No 642/2014 ("the Single Basic Act")⁴². This Regulation sets up nine joint undertakings – including EU-Rail - within the meaning of Article 187 TFEU for the implementation of institutionalised European partnerships referred to in Article 10(1), point (c), of the Horizon Europe Regulation. It determines their objectives and tasks, membership, organisation and other operating rules.
- The General Financial Regulation (EU, Euratom) 2018/1046⁴³, subject to any specific provisions of the Financial Rules of EU-Rail and the Single Basic Act,
- The Financial Rules of EU-Rail⁴⁴, adopted by the Governing Board Decision N° 11/2019 of 20 December 2019⁴⁵ and entering into force on 1 January 2020.
- The EU-Rail Governing Board (GB) Decisions adopted since its establishment, which frame the functioning of EU-Rail, within the boundaries of the Single Basic Act and the EU-Rail Financial Rules, in particular the EU-Rail multiannual work programme 2022-2024 and its amendments⁴⁶ approved by the GB (draft budget, Staff Establishment Plan, Scientific Priorities, calls, tenders,

⁴¹ EU-Rail GB Decision n° 02/2021. The list is available at: <https://rail-research.europa.eu/about-europes-rail/europes-rail-structure-of-governance/europes-rail-governing-board/>

⁴² OJ L 427, 30.11.2021, p. 17–119

⁴³ Regulation (EU, Euratom) 2018/1046 of the European Parliament and of the Council of 18 July 2018 on the financial rules applicable to the general budget of the Union, amending Regulations (EU) No 1296/2013, (EU) No 1301/2013, (EU) No 1303/2013, (EU) No 1304/2013, (EU) No 1309/2013, (EU) No 1316/2013, (EU) No 223/2014, (EU) No 283/2014, and Decision No 541/2014/EU and repealing Regulation (EU, Euratom) No 966/2012. OJ L 193, 30.7.2018, p.1.

⁴⁴ By Delegated Regulation (EU) 2019/887, the Commission adopted the model financial regulation for public-private partnership bodies to ensure sound financial management of Union funds and to enable public-private partnership bodies like S2R JU to adopt their own financial rules. The model financial regulation should be consistent with the provisions of Regulation (EU, Euratom) 2018/1046. The S2R JU shall adopt its financial rules in accordance with this model financial regulation.

⁴⁵ <https://rail-research.europa.eu/wp-content/uploads/2020/01/S2R-JU-Financial-Rules.pdf>

⁴⁶ <https://rail-research.europa.eu/about-europes-rail/europes-rail-reference-documents/europes-rail-annual-work-plan-and-budget/>

etc.). As indicated in the EU-Rail GB Rules of Procedure, once adopted, the GB decisions are published on the EU-Rail website⁴⁷.

In addition:

- Regulation (EU) 2021/695 of the European Parliament and of the Council of 28 April 2021 establishing Horizon Europe – the Framework Programme for Research and Innovation, laying down its rules for participation and dissemination, and repealing Regulations (EU) No 1290/2013 and (EU) No 1291/2013⁴⁸. This regulation) establishes the policy and legal framework for European partnerships with private or public sector partners. European partnerships are a key element of the policy approach of Horizon Europe – the Framework Programme for Research and Innovation ('Horizon Europe').
- The Staff Regulations of officials and the conditions of employment of other servants of the European Union are applicable to the staff of the JU.

Additional reference documents can be found on the JU's dedicated webpage:

<https://rail-research.europa.eu/about-europes-rail/europes-rail-reference-documents/>

2.3. Budgetary and financial management

STATEMENT OF REVENUE	Voted Budget 2022 - A1 (with EU-Rail Programme Budget included at 01/03/2023)		Budget as finally adopted 2022	
	Commitment appropriations (in EUR)	Payment appropriations (in EUR)	Commitment appropriations (in EUR)	Payment appropriations (in EUR)
<i>Heading</i>				
EU contribution excl. EFTA	163.590.298	154.140.257	164.290.298	154.490.257
<i>of which Administrative</i>	3.463.928	4.669.633	3.463.928	4.669.633
<i>of which Operational</i>	160.126.370	149.470.624	160.826.370	149.820.624
Third countries contribution including EFTA	2.237.580	3.328.732	2.237.580	3.328.732
<i>of which Administrative</i>	56.709	82.150	56.709	82.150
<i>of which Operational</i>	2.180.871	3.246.582	2.180.871	3.246.582
Industry financial contribution	4.751.783	4.751.783	4.751.783	4.751.783
<i>of which Administrative</i>	4.751.783	4.751.783	4.751.783	4.751.783
Interest generated	-	-	501	501

⁴⁷ <https://rail-research.europa.eu/about-europes-rail/europes-rail-structure-of-governance/europes-rail-governing-board/>

⁴⁸ OJ L 170, 12.5.2021, p. 1–68

Unused appropriations from previous years	-	18.126.076	146.153	18.272.229
Of which administrative	-	626.076	2.523	628.599
Of which operational	-	17.500.000	143.630	17.643.630
TOTAL ESTIMATE REVENUE	170.579.661	180.346.848	171.426.316	180.843.502

STATEMENT OF EXPENDITURE	[Amended - A3] budget 2022 (AWP)	[Amended] budget 2022 after transfers	Executed Budget 2022	%	Available for future use (N+3 rule)
(Commitment appropriations)					
Title 1 - Staff expenditure	2.865.632	2.879.095	2.876.572	100%	2.523
Salaries & allowances	2.448.000	2.486.531	2.486.531	100%	-
Mission expenses	110.000	100.000	100.000	100%	-
Training	50.000	30.849	30.849	100%	-
Other Staff related expenditure	257.632	261.714	259.191	99%	2.523
Title 2 - Infrastructure and operating expenditure	2.111.368	2.100.429	2.100.429	100%	-
Rental of buildings and associated costs	345.000	409.688	409.688	100%	-
Information, communication technology and data processing	150.000	148.307	148.307	100%	-
Movable property and associated costs	10.000	-	-		-
Current administrative expenditure	15.000	10.975	10.975	100%	-
Postage / Telecommunications	15.000	9.534	9.534	100%	-
Meeting expenses	50.000	18.096	18.096	100%	-
Running costs in connection with operational activities	646.368	627.533	627.533	100%	-
Information and publishing	720.000	716.296	716.296	100%	-
Other infrastructure and operating expenditure	160.000	160.000	160.000	100%	-
Title 3 - 4 - Operational expenditure	164.507.241	164.650.871	164.528.308	100%	122.563
S2R Programme	-	143.630	21.067	15%	122.563
EU-Rail Programme	164.507.241	164.507.241	164.507.241	100%	-

Title 5 - Unused appropriations not required in current year	1.795.420	1.795.921	-	0%	1.795.921
TOTAL	171.279.661	171.426.316	169.505.308	99%	1.921.007

STATEMENT OF EXPENDITURE	[Amended - A3] budget 2022 (AWP)	[Amended] budget 2022 after transfers	Executed Budget 2022	%	Available for future use (N+3 rule)
<i>(Payment appropriations)</i>					
Title 1 - Staff expenditure	2.903.000	2.888.382	2.718.804	94%	169.578
Salaries & allowances	2.389.000	2.387.859	2.387.685	100%	174
Mission expenses	110.000	110.000	88.490	80%	21.510
Training	50.000	50.000	9.295	19%	40.705
Other Staff related expenditure	354.000	340.523	233.334	69%	107.190
Title 2 - Infrastructure and operating expenditure	2.074.000	2.091.141	1.455.932	70%	635.209
Rental of buildings and associated costs	355.000	355.000	321.077	90%	33.923
Information, communication technology and data processing	250.000	250.000	228.139	91%	21.861
Movable property and associated costs	10.000	10.000	-		10.000
Current administrative expenditure	15.000	15.000	10.995	73%	4.005
Postage / Telecommunications	15.000	15.000	5.431	36%	9.569
Meeting expenses	40.000	40.000	15.703	39%	24.297
Running costs in connection with operational activities	642.000	523.141	59.468	11%	463.673
Information and publishing	560.000	685.000	649.250	95%	35.751
Other infrastructure and operating expenditure	187.000	198.000	165.870	84%	32.130
Title 3 - 4 - Operational expenditure	171.570.980	171.714.610	135.624.441	79%	36.090.168
S2R Programme	60.426.695	60.570.325	28.210.923	47%	32.359.402
EU-Rail Programme	111.144.285	111.144.285	107.413.519	97%	3.730.766

Title 5 - Unused appropriations not required in current year	4.148.868	4.149.369	-	0%	4.149.369
TOTAL	180.696.848	180.843.502	139.799.177	77%	41.044.325

At the year-end 2022, the JU had implemented 100% of its commitment appropriations made available in its active budget (Titles 1 to 3). The payment appropriations were implemented up to 79.1% of the active funds (respectively 79% of implementation when compared to the full JU budget including Title 4).

By means of the GB Decision 08/2021 of 25 November, the S2R Governing Board adopted the initial Annual Work Plan and Budget for 2022 which continued to apply to EU-Rail by means of adoption by the EU-Rail Governing Board of the so-called "omnibus decision".

By the time of such adoption, the budget appropriations included in the Budget 2022 were not foreseen to cover the full financial year 2022, but to ensure the running of the activities till the launch of the new partnership, the Europe's Rail Joint Undertaking, and to ensure the necessary business continuity of the activities.

There were three amendments to the initial budget adopted during 2022:

- Amendment number 1

The Executive Director proposed to the Governing Board a first amendment in order to ensure that the EU-Rail Programme budget was included for the year 2022 following the official initiation of the new Partnership.

In addition, the Work Programme 2022 was also converted into a multi-annual work programme that included the activities that will be performed in 2022 related to the launch of its new Research and Innovation (R&I) Programme governed by the Horizon Europe rules (in particular two calls for proposals) as well as estimated figures for the following years up to 2024. This could be done in accordance with the new legal and financial regulatory options offered with the new SBA adoption.

- Amendment number 2

The Executive Director proposed to the Governing Board adaptation of the Budget as follows:

Statement of Revenue

Following the signature in 2022 of a Contribution Agreement between the European Union, represented by the European Commission, and EU-Rail, with the objective to provide a financial contribution to finance the implementation of the action "Pilot project – IRS Smart Cities project: new railway station concept for green and socially inclusive smart cities", the revenue of EU-Rail 2022 was increased by EUR 700.000 in Commitment appropriations and EUR 350.000 in Payment appropriations (50% of pre-financing for 2022). The EUR 700.000 were used for an additional topic, dedicated to the Smart Cities pilot project, of the Call for proposal 2022-2 for exploratory research that was launched in September 2022. In accordance with the SBA Article 10(4), the EUR 700.000 of new revenue in 2022 are corresponding to additional Union funds complementing the contribution allocated to the EU-Rail Programme implementing Horizon Europe. In this respect, and in accordance with the SBA Article 10(6), this additional contribution from Union programmes corresponding to additional tasks entrusted to EU-Rail shall not be accounted for in the calculation of the Union maximum financial contribution to the EU-Rail Programme.

Statement of Expenditure

Title I and II: minor adaptation of the Budget appropriations per line was proposed considering the evolution of budget needs identified after the first half of 2022. The main change consisted in transferring budget from the Salaries and allowances budget lines (Title I) to the running costs in connection with operational

activities (Title II). This was possible due to the fact that most of the recruitment procedures to fill the new positions following from the Staff Establishment Plan (comprising in total 29 staff members) were still ongoing at that time. Consequently, in order to ensure the continuity of operations in setting up of the EU-Rail activities, this available budget was re-allocated accordingly, making use of existing Framework Contract of the JU (Strategic Support).

Title IV (EU-Rail Programme): following the late adoption of the SBA, the EU-Rail has collected the contributions for administrative costs of both years 2021 and 2022, in 2022. Leading to the inscription of unused administrative appropriations of EUR 3,3 million in Title V of the Budget 2022 related to the financial year 2021. In order to maximize the performance and impact of the JU, taking into consideration the above background information, the Executive Director proposed to the Governing Board to transfer the amount of unused appropriations for the running costs of the JU for the amount of EUR 1,5 million to Title 4 for operational activities. This possibility is established in the SBA Article 28(5) mentioning that any unused part of the contribution for administrative costs may be made available to cover the operational costs of the JU, in particular, an additional topic in relation to the European DAC Delivery Programme activities.

In addition, the operational budget was increased by additional EUR 700.000 for the inclusion of the topic "Smart Cities" in the call 2022-2. Consequently, the call 2022-2 was increased by EUR 2,2 million for two additional topics, thus its new total amounted to EUR 14,7 million.

- Amendment number 3

The Executive Director proposed to the Governing Board minor adaptation of the Budget appropriations per line considering the evolution of budget needs identified for the last Quarter 2022.

The transfers from Title 1 to Title 2 were planned to ensure the JU activities – Innovation and System Pillar Programme Managers and System Engineers – making use of external support, until the recruitment process of the new staff is completed. The full staffing was expected to be reached by yearend only. The transfers were proposed and adopted by respecting the JU's Financial Rules providing a limit of 10% for budget transfers between titles to be authorised by the ED.

From the budgetary management perspective, 2022 was also challenging with regard to the high number of communication events and the commitment related to InnoTrans 2024 that has to be added by yearend 2022.

Implementation of the Budget

Administrative costs (Title 1 Staff Expenditure and Infrastructure and Title 2 Operating Expenditure)

Title 1 and Title 2 of the Budget were executed up to 100% in commitment appropriations, demonstrating a reliable budgetary planning.

Title 1 - Staff Expenditure was mainly used for the salaries of the JU staff. During the year, the JU also made use of external support to fill the gaps until the recruitments of staff are finalized and to cope with the workload related to the JU activities.

Title 2 – the administrative expenditure was mainly used to ensure the JU activities, such as the Innovation and System Pillar Programme Managers and System Engineers, by making use of external support until the recruitment process of the new staff is completed. Covering the high number of communication events and the commitment for InnoTrans 2024 also represented a relevant part of expenditure under this Title.

The implementation rate of payment appropriations was 84% (95% in 2021). The decrease in implementation of payment appropriations in comparison to the previous budgetary year was mainly attributable to the fact that the JU could only expect to reach its full staffing by the end of the year at the earliest.

Title 3 and Title 4 Operational Expenditure

Title 3 of the Budget constitutes the JU's Operational Budget for implementation of the S2R Programme activities, while Title 4 represents the JU's Operational Budget for the implementation of the new EU-Rail Programme activities.

This part of the Budget represents 97% of the active (Titles 1 to 4) and overall budget (including Title 4). The proportion has considerably increased in 2022 compared to the previous year (70% in 2021), since EUR 164,5 million was made available to be allocated to EU-Rail operational commitment appropriations in 2022, being the initial year of the EU-Rail Programme activities.

Title 3 of the Budget covers the interim and final payments implementing the S2R Programme in relation to the remaining grant agreements, operational procurements and expert fees.

Title 4 of the Budget covers the launch of the first call for proposal of the EU-Rail Programme representing total funding of EUR 234 million by applying the multi-annual instalment approach (EUR 135,7 million of CA used in 2022). Further expenditures within this Title were related to the second call for proposal for Exploratory Research (EUR 14,7 million), to the tenders for the System Pillar activities and to other tenders and studies.

The implementation rate of the Operational Budget in commitment appropriations was 100% and 79% in payment appropriations (84% in 2021). In 2022, a major portion of payment appropriations was used for the pre-financing of the grants resulting from the first 2022 call for proposal. The above implementation rate also includes EUR 76.000 relating to the Expert Evaluators which are managed by the REA Services.

Title 5 Unused appropriations not required in current year

The amount included under Title 5 – Unused appropriations not required in current year - has been established to support a transparent implementation of JU Financial Rules' Article 6.5, the so-called n+3 rule. In accordance with this rule and the general practice of the JU, these appropriations will be reactivated in the future year budget(s) and used first.

The finally adopted 2022 Budget includes EUR 1,8 million of unused administrative commitment appropriations, after EUR 1,5 million had been transferred to Title 4 following the Budget amendment nr. 2, and EUR 4,1 million of unused payment appropriations (for both S2R and EU-Rail Programmes and for both administrative and operational budget) that will be re-inscribed in revenue and expenditure in the following years.

2.4. Financial and in-kind contributions from Members other than the Union

The in-kind contributions result from the activities carried out by the JU's members other than the Union, funded by the JU when in relation of awarded actions (IKOP) and/or not funded by the JU (usually Additional Activities and/or IKAA). They are not revenues in accordance with the budgetary accounting, hence they are not reported in the Budgetary tables and shall be excluded from any other purposes than the achievement of the SBA objectives.

Nevertheless, they constitute the essential component of the "partnership" nature of the Joint Undertaking.

2.4.1. Europe's Rail in-kind Contributions

As the EU-Rail started official on 30 November 2021, the operational activities performed in December 2021 and in 2022 in relation to EU-Rail are already summarized in Annex G. No contributions were received from its Private Members under the framework of the SBA.

2.4.2. S2R in-kind Contributions

The in-kind contributions received and reported in 2022 are solely related to the S2R Regulation.

In accordance with Article 174 of the Single Basic Act, Europe's Rail JU (hereinafter EU-Rail) is the legal and universal successor of the Shift2Rail JU (S2R JU). The rights and obligations in relation to the Shift2Rail Programme, hence, remain applicable under the current legal framework.

In this respect, in accordance with article 4(3) of the S2R Regulation, "the members of the S2R Joint Undertaking other than the Union shall report by 31 January each year to the Governing Board of the S2R JU on the value of the contributions referred to in paragraph 2 made in each of the previous financial years".

Article 4(2) of the S2R Regulation establishes that the total contribution to be provided by the Other Members⁴⁹ and totalling EUR 470 million shall consist of:

IKOP⁵⁰ (in-kind operational): at least EUR 350 million, including at least EUR 200 million from the founding members other than the Union and their affiliated entities, and at least EUR 150 million from associated members and their affiliated entities. In accordance with Article 16(3)b of the S2R Statutes, IKOP consists "of the costs incurred by them [the S2R Other Members] in implementing indirect actions less the contribution of the S2R JU and any other Union contribution to those costs".

IKAA (in-kind other activities): of at least EUR 120 million, of which at least EUR 70 million from the founding members other than the Union and their affiliated entities, and at least EUR 50 million from associated members and their affiliated entities. These contributions shall consist of the costs incurred by them in implementing additional activities outside the work plan of the S2R Joint Undertaking, which are complementary to this work plan and contribute to the objectives of the S2R Master Plan. Other Union funding programmes may support those costs in compliance with the applicable rules and procedures. In such cases, Union financing shall not substitute for the in-kind contributions from the Members other than the Union or their affiliated entities.

The aforementioned in-kind contributions, which consist of financial expenditure executed by the Members – salaries, assets, operations, etc. – to achieve the S2R Programme and its Projects, are in addition to the cash contribution of the S2R Other Members to the 50% of the running costs of the JU.

S2R Other Members' reporting for 2022

The Other Members of S2R submitted their reporting on IKOP and IKAA to the JU by 31 January 2023. The Lighthouse projects are excluded from this reporting as assimilated to open calls and within the administrative management of the European Commission.

This report covers IKOP related R&I activities as from Sept 2016 till Dec 2022; in terms of IKAA the activities are considered eligible as from the date of acceptance by the S2R Other Members of the S2R JU Statutes, by means of their respective letters of endorsement.

In accordance with Article 4(4) of the S2R Regulation, the S2R Other Members shall have the costs related to IKOP and IKAA certified by an independent external auditor appointed by the entity concerned.

IKOP and IKAA Certification

By 30 April 2023, the S2R Other Members have provided the JU with audit certificates on the IKOP and IKAA costs declared for the year 2022. After due examination of the relevant certification and, in particular, the audit standards applied to the issuance of the "audit certificates", the acceptable corresponding IKOP contributions have been "validated" by the Executive Director and will therefore be accounted towards the obligation set in Article 4(2) of S2R Regulation to the S2R Other Members as well as recorded as Net Assets of the Joint Undertaking in the Annual Accounts 2022.

With regard to the Final Accounts of EU-Rail, all IKOP contribution reported but not validated in 2022 will be accounted for "to be validated" considering that:

⁴⁹ The "Other Members" consist of the Founding Members of S2R, with the exclusion of the Union, and the Associated Members.

⁵⁰ As laid down in Article 16(2) and Article 16(3)(b) of the S2R Statutes.

- 92% of the IKOP reported "to be validated" is supported by the relevant certification; the rest is expected to be certified by year end;
- in accordance with the accounting principles, IKOP of year n-1 will be accounting for only in year n accounts, if and once validated in year n.

Additional information

IKOP

The progress is well in line with the usual Programme Management S-Curve (with 76% of linear time consumed since September 2016 and with 94.1% of the IKOP objective reported).

As indicated under the definition of IKOP, these costs represent the difference between the Total Project Value of S2R projects and the EU-Rail co-funding (or estimated).

The 2022 IKOP is the cumulative result of the activities awarded by EU-Rail to the S2R Other Members:

	<i>EUR million</i>		R&I activities		%
		awarded and signed	realized		
			Sept 16 - Dec 21	2022	
Total Value	618,1	97,5	567,0	91,7%	
S2R co-funding	271,9	52,4	246,3	90,6%	
IKOP	346,2	45,1	320,7	92,6%	

In order to allow EU-Rail to be in the position to sign the relevant grant agreements, the Union provided the necessary Commitment Appropriations to match the S2R Programme co-funding of EUR 271.9 million above (excluding OC), against the S2R Other Members' commitment of EUR 618.1 million. In terms of Union Payment Appropriations, they were used to provide the pre-financing up to 45% till 2019 and 55% for the call 2020 (to maintain cash flow in the current economic negative situation created by the C-19 pandemic) of the estimated funding in accordance with the relevant provisions of the grant agreements. In 2021, only two projects were signed following the call 2021 with limited contribution and impact from the S2R Other Members'.

It should be noted that the estimated requested co-funding included in the 2021 Other Members' declarations is within the limits of the provision of the relevant Membership Agreements. In fact, Article 2.2 of each Other Member's Membership Agreement signed with EU-Rail establishes that "the Member agrees to limit its reimbursement request in indirect actions funded under Article 3(1)(a) of the S2R JU Regulation to an amount not exceeding 44.44% of the Member's total eligible costs in implementing indirect actions. In case of research and innovation activities delivering the expected results through a series of intertwined actions throughout successive S2R JU Annual Work Plans, and without prejudice to the provisions concerning co-funding rates established in the S2R JU Annual Work Plans, this 44.44% threshold shall be applied cumulatively taking into account the final amount of reimbursement requested at the end of the last action implementing the specific intertwined research and innovation activities".

The percentage resulting from the cumulative reimbursement requests in all indirect actions for S2R Other Members in 2022 is 43.45%, within the maximum level of 44.44%.

However, it is to be noted that the intermediary reports of the following Members show the most important deviation with respect to an IKOP rate below 55.56%.

This will be brought to the attention of the Governing Board for any remedial action to be taken and followed up by the EU-Rail in 2023 and in any case will result in a grant final payment which will correspond in a cumulative rate not exceeding⁵¹ 44.44% rate.

- Founding Members:
 - Hitachi 44.97%
 - Network Rail 54.80%

- Associated Members:
 - Aerfitec 44.87%
 - Amadeus 52.76%
 - EUROOC 46.44%
 - Hacon 44.93%
 - Indra 48.10%
 - Kontron 45.20%
 - SmartDemain 55.29%
 - SmartRacon 46.17%
 - SNCF 51.24%
 - Switracken 45.41%
 - Talgo 45.96%

IKAA

In terms of IKAA, the total expected contribution by the end of the S2R Programme is now estimated, subject to certification, at EUR 244.0 million, 103% above the regulatory obligation of minimum EUR 120 million. It is to be noted that EUR 195.1 million have been certified (63% above the regulatory obligation confirmed).

⁵¹ In this respect, the Governing Board adopted Decision 16/2018 amending the S2R Other Members' model Membership Agreement.

On 1 May 2023, based on the declarations and the Projects' cost statements, the situation of IKOP and ICAA was the following:

Other Members	TOTAL PROJECT COST				TPC/IKOP REPORTING			CO-FUNDING			IKOP			Validated as Net Assets	To be validated	Deviance as per MA Art 2(2)
	AAR 2016 - AAR 2021	AAR 2022	TOTAL	of which CERTIFIED	AAR 2016 - AAR 2021	AAR 2022	TOTAL	AAR 2016 - AAR 2021	AAR 2022	TOTAL						
Alstom	44.959.313	4.946.874	49.906.187	49.906.187	19.772.513	1.260.417	21.032.930	25.186.800	3.686.457	28.873.256	25.462.393	3.410.864	42,14%			
Hitachi / Ansaldo STS	36.451.069	8.480.529	44.931.598	44.927.998	15.799.382	4.405.574	20.204.956	20.651.687	4.074.955	24.726.642	20.176.064	4.550.578	44,97%			
Bombardier Transportation	33.239.680	9.020.207	42.259.887	33.137.341	13.761.667	3.951.024	17.712.691	19.478.013	5.069.183	24.547.196	19.487.735	5.059.461	41,91%			
CAF	33.659.995	5.003.877	38.663.871	38.663.871	13.412.529	3.153.379	16.565.908	20.247.466	1.850.498	22.097.964	18.867.328	3.230.635	42,85%			
Network Rail	19.389.092	5.303.377	24.692.469	15.732.160	9.382.248	4.148.674	13.530.922	10.006.844	1.154.702	11.161.547	7.786.024	3.375.523	54,80%			
Siemens	36.622.433	8.370.748	44.993.181	44.847.340	17.224.593	2.725.497	19.950.090	19.397.840	5.645.251	25.043.091	20.148.731	4.894.360	44,34%			
Thales	30.997.190	3.034.625	34.031.815	30.424.390	13.431.320	1.295.209	14.726.529	17.565.870	1.739.416	19.305.286	16.005.962	3.299.324	43,27%			
Trafikverket	33.713.502	6.307.448	40.020.950	39.468.604	10.967.248	5.358.187	16.325.435	22.746.254	949.261	23.695.515	19.881.061	3.814.453	40,79%			
Founding Members	269.032.273	50.467.684	319.499.958	297.107.890	113.751.500	26.297.961	140.049.462	155.280.773	24.169.723	179.450.496	147.815.298	31.635.198				
Aerfitec	10.797.660	45.667	10.843.327	8.133.031	4.572.715	292.975	4.865.690	6.224.945	247.307	5.977.638	4.225.912	1.751.726	44,87%			
Amadeus	4.514.883	-	4.514.883	4.508.487	2.382.149	-	2.382.149	2.132.734	-	2.132.734	2.126.339	6.395	52,76%			
AZD Praha	5.961.364	1.983.341	7.944.705	7.944.705	3.192.967	294.460	3.487.427	2.768.397	1.688.881	4.457.278	3.065.834	1.391.444	43,90%			
Competitive Freight Wagon	5.527.148	1.513.271	7.040.419	5.151.063	2.547.214	531.799	3.079.013	2.979.934	981.472	3.961.406	2.896.724	1.064.683	43,73%			
Deutsche Bahn AG	41.675.442	7.431.996	49.107.438	49.107.438	12.974.749	5.253.557	18.228.306	28.700.693	2.178.438	30.879.132	25.030.937	5.848.194	37,12%			
Diginext	4.908.708	1.057.964	5.966.672	4.908.708	2.149.934	458.354	2.608.288	2.758.774	599.610	3.358.384	2.747.546	610.838	43,71%			
EUROC	2.473.969	2.317.499	4.791.468	2.976.965	875.651	1.349.534	2.225.185	1.598.319	967.965	2.566.283	1.139.266	1.427.017	46,44%			
Faiveley - Wabtec	15.321.021	2.305.386	17.626.407	16.931.849	5.679.254	1.087.681	6.766.935	9.641.766	1.217.705	10.859.471	7.847.138	3.012.333	38,39%			
Hacon	13.482.606	4.284.989	17.767.595	17.767.595	5.775.963	2.207.694	7.983.657	7.706.643	2.077.295	9.783.938	7.431.948	2.351.990	44,93%			
Indra	19.018.555	4.960.634	23.979.188	18.539.073	8.631.847	2.903.105	11.534.953	10.386.707	2.057.528	12.444.236	9.475.844	2.968.392	48,10%			
Kontron - Kapsch	7.346.267	254.101	7.600.368	7.597.270	3.087.861	347.317	3.435.178	4.258.406	93.216	4.165.190	3.755.649	409.541	45,20%			
KnorrBremse	11.083.965	2.984.681	14.068.647	14.068.647	3.502.476	849.585	4.352.061	7.581.489	2.135.096	9.716.586	5.368.183	4.348.402	30,93%			
MerMec	6.910.954	1.344.634	8.255.588	8.255.588	3.166.249	337.789	3.504.038	3.744.705	1.006.845	4.751.550	3.911.148	840.403	42,44%			
SmartDeMain	7.322.936	1.675.289	8.998.225	7.695.699	2.993.112	1.981.768	4.974.880	4.329.824	306.480	4.023.344	3.871.890	151.455	55,29%			
SmartRaCon	8.879.331	2.464.624	11.343.955	9.024.466	5.281.010	43.877	5.237.133	3.598.321	2.508.501	6.106.821	4.875.471	1.231.350	46,17%			
SNCF	8.784.462	2.613.363	11.397.825	11.332.718	3.125.187	2.714.585	5.839.772	5.659.276	101.223	5.558.053	4.307.430	1.250.623	51,24%			
SWITRACKEN	4.909.856	2.534.521	7.444.378	4.595.596	1.912.679	1.468.049	3.380.729	2.997.177	1.066.472	4.063.649	2.470.101	1.593.548	45,41%			
Talgo	7.231.594	3.218.886	10.450.480	10.450.480	3.579.752	1.223.290	4.803.042	3.651.843	1.995.595	5.647.438	3.698.347	1.949.091	45,96%			
Virtual Vehicle Austria Consortium VVAC+	14.343.860	4.025.590	18.369.450	17.124.221	4.794.318	2.812.482	7.606.800	9.549.542	1.213.108	10.762.650	7.100.009	3.662.640	41,41%			
Associated Members	200.494.580	47.016.436	247.511.016	226.113.596	80.225.085	26.070.150	106.295.235	120.269.495	20.946.285	141.215.781	105.345.716	35.870.065				
Total	469.526.853	97.484.120	567.010.974	523.221.486	193.976.585	52.368.112	246.344.697	275.550.269	45.116.008	320.666.277	253.161.014	67.505.263	43,45%			

Other Members	IKAA REPORTING			of which Certified as at 1 June 2022
	In-Kind Additional Activities as at 31 December 2022	In-Kind Additional Activities certified at 30 April 2023	TOTAL	
Alstom	11.912.418	-	11.912.418	11.912.418
Hitachi / Ansaldo STS	9.766.840	340.473	10.107.313	9.854.167
Bombardier Transportation	15.688.168	-	15.688.168	15.688.168
CAF	20.432.481	-	20.432.481	8.946.296
Network Rail	2.220.203	-	2.220.203	-
Siemens	10.950.000	-	10.950.000	10.950.000
Thales	26.936.033	-	26.936.033	26.936.033
Trafikverket	25.159.312	-	25.159.312	-
Founding Members	123.065.455	340.473	123.405.928	84.287.082
Aerfitec	2.568.448	131.601	2.700.049	1.980.585
Amadeus	17.496.678	-	17.496.678	17.496.678
AZD Praha	3.166.080	461.800	3.627.880	3.314.000
Competitive Freight Wagon	815.996	-	815.996	326.103
Deutsche Bahn AG	29.084.129	-	29.084.129	29.084.129
Diginext	1.552.447	-	1.552.447	886.203
EUROC	3.880.016	1.397.687	5.277.703	1.397.687
Faiveley - Wabtec	4.728.740	-	4.728.740	4.562.939
Hacon	18.045.346	682.014	18.727.360	18.292.391
Indra	5.824.412	-	5.824.412	5.218.316
Kontron - Kapsch	3.980.835	-	3.980.835	3.980.835
KnorrBremse	9.551.294	-	9.551.294	9.372.373
MerMec	2.620.245	46.769	2.667.014	2.667.014
SmartDeMain	3.493.721	-	3.493.721	2.782.822
SmartRaCon	1.128.593	-	1.128.593	689.759
SNCF	934.632	-	934.632	404.414
SWITRACKEN	211.892	-	211.892	2.461
Talgo	2.906.321	-	2.906.321	2.906.321
Virtual Vehicle Austria Consortium VVAC+	5.886.907	-	5.886.907	5.403.795
Associated Members	117.876.735	2.719.871	120.596.606	110.768.825
Total	240.942.190	3.060.344	244.002.534	195.055.907

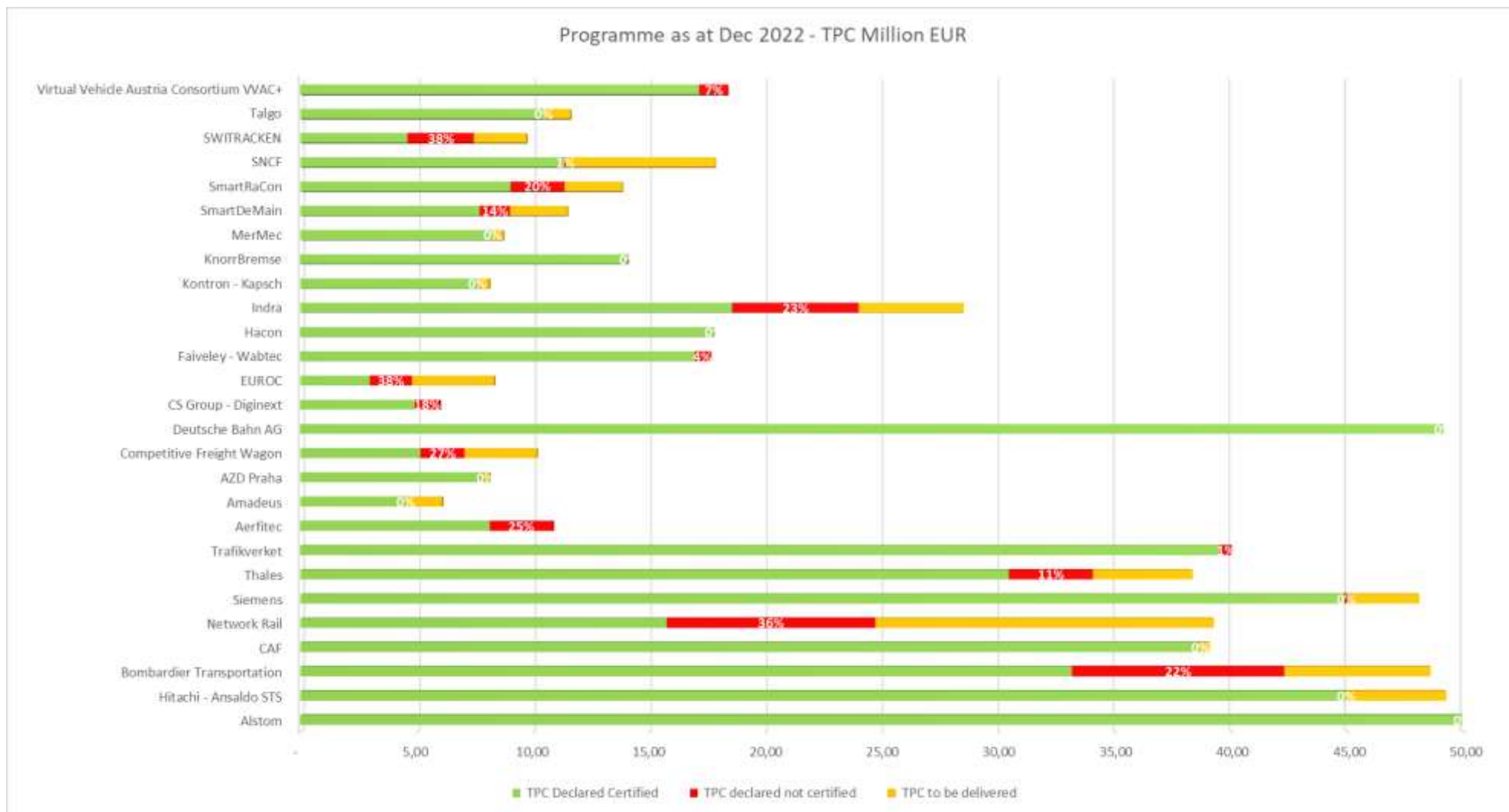

2.5. Administrative Procurement and contracts

In order to reach its objectives and adequately support its operations and infrastructures, the JU continued in 2022 to allocate funds by procuring the necessary services and supplies. In the interest of sound financial management the JU made, to the possible extent, use of Service Level Agreements (SLAs) with relevant Commission services and EU Agencies (such as in the field of ICT, training, payroll, mission, experts reimbursements, interim staff, etc.). Except for the SLA implementing the back office arrangements for the accounting services with other JUs, EU-Rail did not sign in 2022 any new SLAs, only amendments to the existing ones to include additional services or to remove services that became obsolete.

In 2022 EU-Rail continued to participate in inter-institutional framework contracts (e.g.: IT, audit, office furniture, insurance, human resources services) by signing Memoranda of Understanding. In particular, to ensure synergies between the JUs, in 2021 a Multiple Framework Service Contract in cascade (4 lots) for communication services was launched between Clean Aviation (lead JU), SESAR and EU-Rail Undertakings. The framework contracts were awarded in February 2022 and in the course of 2022 EU-Rail implemented several specific contracts (4 lots).

In 2022 EU-Rail awarded a negotiated procedure without prior publication of a contract notice⁵² related to the InnoTrans 2024 event. InnoTrans 2024 event organiser confirmed that company Messe Berlin GmbH was the sole economic operator centralising the allocation of the stands and the organisation of the InnoTrans 2024 fair, taking place at Berlin (Germany) on 24 – 27 September 2024. Therefore, EU-Rail procured the booking of the EU-Rail, DG MOVE and ERA stands with this company. The awarded amount was EUR 86,770.

Where SLAs or a FWCs were not available for specific services or supplies, the JU resorted to middle and low-value contracts. In particular, in 2022 EU-Rail launched a negotiated procedure for a middle value contract⁵³ for the provision of a lump sum ex-post audit guidance. However, no tenders were submitted, thus, the procedure resulted in not awarding any contract.

In accordance with Article 15 (Principle of transparency) of the EU-Rail Financial Rules the JU shall make available on its internet site no later than 30 June of the following financial year information on the recipients of funds deriving from its budget, including procurement contracts. In addition, as stated in point 3.3 of Annex I to the Financial Regulation 2018/1046 (which applies to the JU), EU-Rail, as a contracting authority, shall publish a list of contracts on its website no later than 30 June of the following financial year for specific contracts and order forms implementing a framework contract. The EU-Rail recipients of Funds and Annual List of Specific Contracts for 2021 are published at <https://rail-research.europa.eu/participate/recipients-shift2rail-funds/>.

In order to establish the maximum values of procurement contracts, where necessary, the JU makes use of the collective experience of its involved staff, its Members and experts, as necessary, driven by the principle of sound financial management. Although this was not formally documented in formal acts, audit trails are available also in the exchanges between the staff and the procurement sector to finalize the call for tenders before the approval by the Executive Director.

In 2022, for open procedures, the JU continued using the e-tendering and the e-submission platforms available from the TED e-Tendering website and accessible on the Funding and Tenders Opportunities portal⁵⁴. In the context of the eProcurement strategy, in 2022 EU-Rail started the on-boarding process of the Public Procurement Management Tool (PPMT), the tool that will replace TED e-notices and e-tendering. The on-boarding process is scheduled to be finalised by Q1-Q2 2023.

During 2022 several guidance documents and templates for procurement procedures continued to be updated by the Chief Legal Officer (i.e.: calendar, tender specifications, opening and evaluation of tenders, award procedures for low value contracts, etc.) to adapt them to JU needs and to the DG BUDG recommendations, in particular to the e-submission procedure. In addition, the register of framework

⁵² Point 11(b) Annex 1 EU Financial Regulation - monopolistic situation

⁵³ <https://rail-research.europa.eu/procurement-opportunities/call-for-expressions-of-interest-to-participate-in-a-call-for-tenders-2/>

⁵⁴ <https://ec.europa.eu/info/funding-tenders/opportunities/portal/screen/home>

contracts, SLAs and Memoranda of Understanding has been regularly updated to ensure a proper follow-up of the SLAs and FWCs in force.

In 2022, the register of procurement contracts built from ABAC legal commitment (LCK) continued to be updated. The “e-contract register” contains records of all JU’s legal commitments (i.e.: “procurement contracts and grant agreements”) and thus serves also as the source of data for publication of the “EU-Rail Annual Recipient of Funds, including all specific contracts implementing framework contracts” information on its website. The register also allows the monitoring of the JU’s consumption of framework contracts.

2.6. IT and logistics

The JU’s focus was on the core activities: since its creation, the JU has been one of the most active promoters of a single approach for all the JUs to the ICT environment, reducing costs, outsourcing, and increasing performance.

In this respect:

a. Use of European Commission applications and framework contracts

The JU has implemented common ICT tools designed and made available by the EC for the financial and call management. These tools are updated and maintained on regular basis by the EC; they require continuous input from the side of the JU, on the one hand, to correct the multiple and repetitive mistakes and, on the other hand, in terms of future developments to meet the expectations of the partnership. The follow-up of these processes absorbs multiple resources of the JU.

In order to ensure the correct usage and implementation of these applications, JU makes use of the training services offered by the EC on these applications.

For the execution of the calls for proposals, the IT systems were used throughout the entire process: for the publication of the call, for the submission and evaluation of the proposals as well as for grant preparation. The EC IT systems “e-submission/e-tendering” have also been used since 2020 by the JU for operational tender procedures.

In addition to the extended use of the Commission financial applications, the JU adopted the EC’s ICT systems for HR (Sysper) and daily document management (ARES) to leverage the EC’s proven working technology solutions already in place, but also to streamline and further harmonize the processes, workflows, procedures of record management, document archiving and electronic document cataloguing, secure storage and document access.

The JU continued to make use of the Commission’s ICT framework contracts to procure all ICT services required to run its activities.

b. Use of European Agencies’ framework contracts, including with or on behalf of other JUs

In addition, EU-Rail participates to the joint strategic ICT plan of the JUs located in the White Atrium building. Since 2018, EU-Rail shares its virtual IT infrastructure that is hosted by a private cloud computing provider and also shares the ICT managed services performed by a private company, in synergy with the other JUs. In 2020, the connectivity to the EC tools has also been migrated to this private cloud, which provides a full mobility and independence from the EU-Rail premises, and which proved to be very efficient during the Covid-19 pandemic. In 2020 and 2021, EU-Rail has also further integrated other agencies to benefit from these services, such as ERA, ELA, BEREC, etc., building upon a unique know-how of synergies’ service model.

In 2020, on behalf of all the JUs, the JU commissioned a Data Protection Impact Assessment (DPIA) and security risk assessment on the migration to Microsoft Office 365 public cloud environment, as required by the adopted EU regulation on the protection of personal data by EU institutions and bodies (Regulation (EU) 2018/1725). The DPIA identified the inherent risks that can be mitigated through a series of identified measures with the conclusion that the residual risks are qualified as “under control”. Along with the progressive implementation of these mitigating measures, EU-Rail started in 2021 to migrate to Office 365 in synergy with the other JUs, first to Teams for meetings, then to SharePoint and OneDrive. The main

Office 365 assets were migrated in 2022, starting with Exchange online as well as the document libraries in SharePoint, and Teams groups in a pilot phase. The mitigating measures and migration for the other assets were implemented at end-2022.

2.7. Human Resources

2.7.1. HR Management

Staff Implementing Rules (SIR) implemented in 2022	
Title of the SIR	Reference and date of the GB decision
General implementing provisions on the conduct of administrative inquiries and disciplinary proceedings.	GB decision 04-2022 of 1 March 2022
Application by analogy of the EC rules implementing the Staff Regulations: <ul style="list-style-type: none"> - Commission Decision C (2021) 8179 of 16 November 2021 laying down general implementing provisions regarding the payment of the education allowance provided for in Article 15 of Annex X to the Staff Regulations to staff members for the duration of temporary assignments to the seat of the institution or any other place of employment in the Union. - Commission Decision C (2022) 1788 of 24 March 2022 on working time and hybrid working. - Commission Decision C (2022) 1715 of 24 March 2022 on home leave for officials, temporary staff and contract staff serving in a third country and repealing Commission Decision C(2013) 9035 final of 16 December 2013. 	GB decision 08-2022 of 24 June 2022
Rules on the secondment of national experts and national experts in professional training to the (Shift2Rail) EU-Rail Joint Undertaking.	GB decision 09-2022 of 24 June 2022

In line with the 2022 Establishment Plan, all recruitment procedures were launched and finalized within the year in order to recruit all the statutory staff. At the end of the year, EU-Rail was staffed with 28 staff members including 1 Seconded National Expert (SNE) which means an occupational rate of 100% for statutory staff / 97% for total staff. In 2022, 4 temporary agents were recruited by means of an external selection procedure, 2 were recruited making use of existing reserve lists (internal and inter-Agency).

In addition to statutory staff members and the SNEs already in place, EU-Rail made recourse to Interim Staff and made use of the European Commission's Bluebook scheme to hire trainees. For the first time the JU signed a traineeship convention to welcome a non-bluebook trainee in the framework of the decision adopted by the Governing Board in 2020 prior to the COVID-19 pandemic.

Further details on the staffing are provided in the Staff Establishment Plan in Annex B.

In addition to recruitment activities, the EU-Rail HR Officer ensured the conduct of day-to-day personnel-related administration not covered by the Commission central services and continued to ensure improvement of all HR processes and to develop its internal guidelines, policies, and legal framework, paying particular attention to how EU Staff Regulations' Implementing Rules shall apply to the JU's particularities (in accordance with Article 110 of the EU Staff Regulations).

Annual appraisal and reclassification exercises were set up by HR within the limits of the Staff Establishment Plan and the EU-Rail Financial Rules.

Further to the adoption of the new Decision on working time and hybrid working, EU-Rail ensured on a continuous basis a good working environment and team spirit. For this purpose, social events and team building activities were proposed on regular basis. In-house trainings/info sessions were also developed and proposed to staff with regard to HR-related aspects and most notably a dedicated training on Ethics and Integrity.

The JU also continued to implement its action plan resulting from its last staff survey. A fit-for-purpose organisational structure with clear roles and responsibilities was designed and the EU-Rail Governance and Process Handbook was adapted in light of the changes to the organisation structure and governance, reflecting the new Programme content and processes.

As a result, on 1 March 2022, the new organizational chart of the Programme Office was adopted by the Governing Board.

In 2022, the gender representation in the JU was as follows:

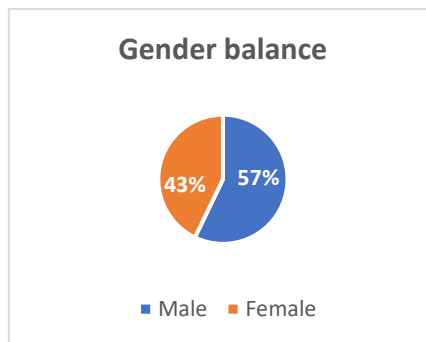

Geographical balance:

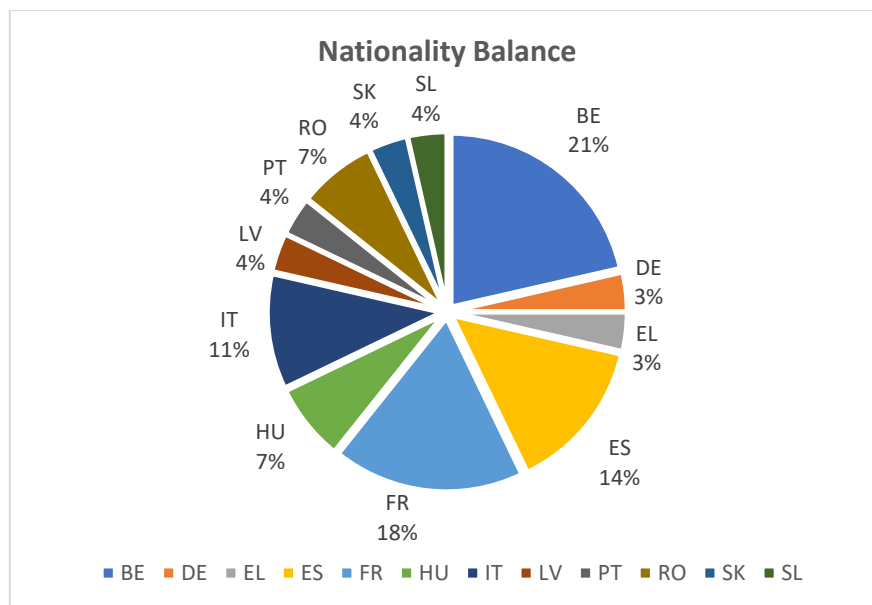

2.7.2. Efficiency gains and synergies

In 2022, the JU's major challenge was to ensure a successful and smooth transition towards the new EU-Rail Programme.

From the HR perspective, EU-Rail is committed to ensuring the well-being of staff and that every staff member reaches their full potential. Trainings were strongly encouraged, and staff events were organised on regular basis in order to reinforce the cohesion of the team, the staff engagement and motivation.

Following its last staff survey, the JU continued to review its processes with the support of a consultancy company and defined 4 main HR areas to work on:

- Develop a future-proof competency framework to guide recruitment and sourcing of expertise;
- Establish a sourcing strategy for ensuring optimal delivery of services with limited resources;
- Establish a talent development plan to provide perspective and training;
- Revamp the approach to performance management focusing on evidence-based recognition and reward.

In 2022, the JU defined priorities among these topics and developed an action plan and indicative timeline for each one of them.

In terms of operational efficiencies, EU-Rail was the first body of the Union together with the Commission to introduce since 2018 the Lump Sum form of granting. Based on the experience acquired and in line with the overall targets of Horizon Europe, the lump sum approach is the primary implementation way of the Programme. This will provide opportunities to focus the resources on added value functions, in particular on the cost effectiveness of the projects towards achieving the EU-Rail Programme results.

In this context, EU-Rail prepared tender procedures in 2022 with the objective to select a tenderer who shall provide its expertise and advice to the EU-Rail in establishing a framework for assurance process for lump sum grants to be implemented by means of reviews/audits as referred to in the Model Grant Agreement. During the year 2023, the JU will implement its first pilot ex-post technical review of a lump sum grant.

The foreseen overall objective of the framework for the conduct of ex-post technical reviews/audits is to set up a framework that would enable the EU-Rail Authorising Officer to obtain reasonable assurance primarily, but not exclusively, on:

- the qualitative (technical) implementation of the respective action, in particular on the fulfilment of the conditions identified per the respective work package (in the sense that the agreed activities were performed),
- compliance with other aspects following from the respective grant agreement such as ethics and research integrity, dissemination and exploitation of results, management of intellectual property, gender equality etc.

In terms of synergies and collaboration with the other Joint Undertakings the Single Basic Act of the Joint Undertakings⁵⁵ establishes that the JUs shall achieve synergies via the establishment of back-office arrangements, operating in some identified areas. The SBA also underlines that these synergies should be implemented where screening of resources has proved to be efficient and cost-effective, while respecting the autonomy and the responsibility of each Authorising Officer.

In order to obtain an independent view on the possible synergies among the JUs and the impact in terms of efficiencies, the JUs contracted an external consultant to perform a study on the common back-office arrangements. The study was finalised in July 2022 and its specific objectives were to:

- Identify areas, or sub-functions of areas, for being operated under Back Office Arrangements, including necessary elements of cost efficiency, risks and opportunities;
- Support the JUs to assess the viability (including the screening of resources) of these areas.

Within the study 21 potential opportunities for synergies among the JUs were identified for all services covered by Article 13 of the SBA. It concluded that the estimated efficiency gains in terms of FTE savings were modest for most synergies, but there were potential benefits in terms of harmonisation of current practices, standardisation of procedures, establishment of critical mass for effective negotiation, coordination and cost savings.

Those synergy opportunities were clustered into three main groups:

⁵⁵ Article 13, Council Regulation (EU) No 2021/2085, of 19 November 2021

- Quick wins (14) – Synergies that scale-up the existing collaboration among the JUs, as a result, these should be potentially implemented in a first wave.
- Long-term solutions (5) – These synergies require further reflection on the structuring and planning of their setup and an accurate assessment of the potential benefits, cost-efficiency and risks.
- Low priority opportunities (2) – Synergies which were identified as less feasible/desirable by the Joint Undertakings due to their limitations in terms of practical applicability and value.

The preferred model for the Back Office Arrangements among JUs is a setup with one JU taking the lead dealing in coordinating tasks with one backup JU, organising the work among staff of several JUs and having a clear scope and decision-making power, as was used in BOA for the provision of accounting services (following DG BUDG decision to terminate the contract with the JUs).

For some synergies a more flexible option was chosen, with collaboration involving only some JUs, while remaining open for the others to join at a later stage.

The preparation work led to establishment of coordinated plans, prioritising those aspects of the BOA that had the objective to bring most value in the short term. These included, as top priorities, (i) the accounting function (ii) IT deployment (iii) common synergies regarding the White Atrium occupation and other buildings that house JUs (iv) joint procurement opportunities and (v) HR support. These topics encompass 5 of the 7 synergies as per SBA Article 13. This approach was endorsed by the respective Governing Boards.

When these arrangements were presented, the respective Governing Boards stressed the need to have a balanced approach to the BOA implementation ensuring, as a priority, the execution of JUs' core businesses (ensuring budget execution and call implementation) which is very challenging in the context of a new programme with new legislation, new actors and ambitious timelines due to the delayed launch of the Horizon Europe programme.

The BOA were put in place in 2022 or submitted for proposal for implementation were:

AREA	CONTENT	LEAD JU
<i>Accounting</i>	Accounting services	EU RAIL JU
<i>ICT</i>	ICT services	Clean Hydrogen JU
<i>HR</i>	Common Recruitment, HR Legal framework and HR digitalisation	CBE JU
<i>Legal</i>	Administrative procurements	Clean Aviation JU

In detail, those BOA were put in place or submitted for proposal through the following action plans:

- **BOA for Accounting Services**

The JUs took over the Accounting services that until 30 November 2022 were provided by DG BUDG. EU-Rail is the lead JU of this BOA. Accounting services will be provided by 3 Accounting Officers coming from the following JUs: CA JU, SESAR JU and EU-Rail JU.

Organisation:

- The Executive Director of the Lead JU is responsible for the organization, oversight and coordination of the accounting services to the other JUs on the basis of an annexe of the BOA SLA.
- The Head of Corporate Services or another officer with the necessary grade, skills and competencies of the Lead JU shall act as Accounting Coordinator of the BOA Accounting Officers.
- The Accounting Officer(s) of the JU Accounting Providers delivers the service to one or more JU Accounting Beneficiary and is responsible for the accounts she/he signs off, while counting on the support and coordination with the lead JU.

In order to ensure the provision of these services, it was agreed between the EC and the JUs to make use of the support of 3 additional Contractual Agents and of an external Accounting Services provider.

The first concrete output of this BOA initiated in 2022, is that by 28 February 2023 in accordance with the Financial Rules, the 3 Accounting Officers successfully transmitted the Provisional Accounts of 8 Joint Undertakings to the ECA and the EC Accounting Officer.

- **BOA HR**

For what concerns the HR domain, the study recommended to explore synergies by coordinating the management of SYSPER, possibly obtaining a single contract for all JUs, perform joint recruitments, harmonise job profiles and procedures.

These synergies will allow to obtain a better harmonisation among the JUs, exploiting best practices, achieving efficiency gains and economy of scale. In particular the areas where this BOA will act are: recruitment, legal framework and IT landscape in the HR domain.

Following the screening of HR resources in each JU, the study also points out no more than marginal FTE gains would be achieved in this area due to the very limited HR dotation of the JUs.

These arrangements were presented to the GB by the end of 2022 and further implementation will take place in 2023, under the lead of CBE JU.

- **BOA ICT**

The ICT area covers a list of ~50 services (service catalogue) structured in 6 service groups:

1. Inter-JU IT Governance,
2. Management of shared ICT infrastructure,
3. Management of ICT tools, services and contracts,
4. Workplace services provision,
5. Security and compliance management,
6. ICT activities specific per JU.

The underlying concept is that, out of the ICT service catalogue, everything that is non-specific to a JU should be managed through the ICT BOA. Therefore, ICT developments and other activities specific to each JU will be under the responsibility of each ED and will not be part of the ICT BOA, that in any case will have to ensure the integrity of the overall ICT architecture.

These arrangements were presented to the GB by the end of 2022 and further implementation will take place in 2023, under the lead of Clean Hydrogen 2 JU.

- **BOA Procurement**

To agree on the concept of the BOA Procurement, the Clean Aviation JU (CA JU) organised on the 7 October 2022 a 'BOA co-design Workshop' addressed to all JUs which expressed their interests in the BOA Procurement, presenting the concept and the principles of the joint cooperation.

This BOA arrangement has been established with the objective of centralising administrative procurement capability and process to maximise open tenders for award of inter-JUs FWCs and middle value negotiated procedures.

The concept was supported by the bi-annual Joint Public Procurement Planning reflecting the common needs identified by the Parties. On this basis a Service Level Agreement was drafted by the BOA Procurement Coordinator (CA JU) and following the conclusion of the consultation and approval by all the JUs is currently under the signature process.

The focus is on the critical joint administrative procurement such as ICT, building management/corporate services and common support services that will be identified and agreed via joint Public Procurement Planning (PPP).

2.8. Data protection

In 2022, the JU continued to implement the EU data protection policies and legal framework. As regards the processing of personal data, the JU applied the current EU Data Protection rules (Regulation (EU) 2018/1725⁵⁶) that entered into force on 11 December 2018. In particular, the JU Data Protection Officer (DPO) followed the recommendations and guidance provided by the European Data Protection Supervisor (EDPS), attended the different data protection meetings and networks, coordinated his work with the other DPOs and provided guidance to JU staff on data protection issues.

To ensure compliance with the data protection principles and synergies with the other Joint Undertakings, EU-Rail took the following actions:

- as a “leading contracting authority” in 2022:
 - continued the monitoring of a common inter-JU central on-line register of records of activities processing personal data (article 31(5) Regulation (EU) 2018/1725) tailor-made to the needs of the JUs;
 - finalised the individual mitigating measures proposed in the inter-JU data protection impact assessment (DPIA) and action plan for the migration to Office 365.
- closely followed up on the introduction of a “joint controllership” clause and a joint controllership arrangement (Article 28(1) of Regulation 2018/1725) in the replacement of the standing SLAs with the European Commission.
- continued to update privacy policies and the central data protection register (<https://rail-research.europa.eu/dpreregister/>) in order to provide transparent information, communication and modalities for the exercise of the rights of the data subjects (Articles 14 to 16 of Regulation (EU) 2018/1725).

In 2022, the DPO finalised the drafting of the EU-Rail Data Protection Action Plan with the assistance of an external contractor. As in the previous year, the role of the DPO was exercised in 2022 by the JU's Chief Legal Officer.

In accordance with article 43(4) of Regulation 2018/1725, in 2022 EU-Rail started the process of exploring the possibility to externalise the DPO function to an external provider via a procurement contract, which is allowed for small or medium sized EU agencies and bodies (article 43(2) of the Regulation). In addition, sharing the same DPO amongst several JUs is in line with the synergies of the back office arrangements in the legal field (Article 13 of the SBA).

⁵⁶ Regulation (EU) 2018/1725 of the European Parliament and of the Council of 23 October 2018 on the protection of natural persons with regard to the processing of personal data by the Union institutions, bodies, offices and agencies and on the free movement of such data, and repealing Regulation (EC) No 45/2001 and Decision No 1247/2002/EC.

3. GOVERNANCE

3.1. Major developments

With the Europe's Rail Joint Undertaking going live after the SBA came into force, several new elements with regard to the organisation and governance of the JU were implemented, reflecting the design of the new EU-Rail Programme built around the two Pillars (the System Pillar and the Innovation Pillar) reinforced by a Deployment Group, including the integration/adaptation of the European DAC Delivery programme in the new structure. Further changes in this respect follow from the new Staff Establishment Plan (additional statutory staff members compared to the S2R JU and creation of the "Senior Programme Managers" layer within the Innovation Pillar Unit). The Governing Board adopted the new EU-Rail organisation structure in its meeting on 1 March 2022 (see annex A).

Furthermore, new JU bodies were introduced as per the SBA (the System Pillar Steering Group) or are to be still introduced (the Deployment Group). On the other hand, the activities of the Innovation Programme's Steering Committees pertaining to the S2R Programme, with more and more S2R projects being finalized, are progressively getting in their phase-out stage.

Finally, in November 2022 the Executive Director announced his decision to step down from the position. Subsequently, as of 1 March 2023, the Head of Programme, Giorgio Travaini, was appointed Executive Director ad interim, until the appointment of the new Executive Director.

Further details on EU-Rail's current governance and organisation are available by means of its [Governance and Process Handbook](#).

3.2. Governing Board

In accordance with the Single Basic Act, the EU-Rail Governing Board (GB) continued its work steering the Europe's Rail through the adoption of decisions to be implemented and executed by the Executive Director. Three ordinary and one extraordinary meetings of the JU Governing Board were convened in 2022. These GB meetings dealt with both operational and administrative aspects. Important decisions were taken, such as adoption of the Europe's Rail Joint Undertaking Master Plan, adoption of the Europe's Rail Joint Undertaking Multi-Annual Work Programme, Work Programme and Budget 2022-2024, with amendments, approval of the CAAR 2021, opinion of the Final Accounts including Budgetary Implementation Report 2021, adoption of the Code of Conduct for the JU Governing Board, and approval of the list of actions proposed by the ED selected for funding under the Europe's Rail Call for Proposals HORIZON-ER-JU-2022-01. The Governing Board also adopted a decision appointing the common Accounting Officer for the Europe's Rail Joint Undertaking. Finally, the GB decided on the application by analogy of Implementing Rules to the Staff Regulations and adopted a decision laying down general implementing provisions on the conduct of administrative inquiries and disciplinary proceedings.

The Governing Board approved the Organisational Structure of the JU Programme Office, the structure of the System Pillar 2022-2023, and the Europe's Rail Joint Undertaking Communication and Dissemination Strategy.

The Executive Director regularly reported to the Governing Board about the Programme, dissemination and communication activities under the Europe's Rail Joint Undertaking, informing the GB Members about the Programme status (i.e., status of calls for proposals HORIZON-ER-JU-2022-01 and HORIZON-ER-JU-2022-02), establishment of the new JU bodies (i.e., discussions on establishment of EU-Rail Scientific Steering Group foreseen in 2023), and the JU-supported events (e.g. launch of Europe's Rail ceremony in Paris; WCRR in Birmingham; InnoTrans 2022 in Berlin; TRA Conference in Lisbon). The Executive Director regularly updated the Board on the System Pillar, the DAC delivery programme and activities of the ED System and Innovation Programme Board.

The Governing Board discussed the expression of interest submitted by the Turkish governmental agency – Tubitak Rute – to become a Member of the Europe's Rail Joint Undertaking based on the provision of Article 87(2) of the Single Basic Act. During its meeting on 1 March 2022, the Governing Board provided the Executive Director with a mandate to investigate the terms and conditions of the possible associated membership of Tubitak Rute to Europe's Rail. At its meeting on 24 June 2022 the Governing Board decided

not to avail itself of the use of Article 87(2) of the Single Basic Act based on the recommendation provided by the Executive Director.

The Governing Board also discussed the progress in establishing the model Consortium Agreement to be used for the projects under the Europe's Rail Programme at its meetings dated 1 March 2022 and 24 June 2022.

The Governing Board, at its meeting on 24 June 2022, gave a mandate to the Executive Director to explore the type of scientific advice under the Europe's Rail Programme. The Executive Director provided the Governing Board with the proposal to launch a call for expression of interest to establish a list of experts to serve under the EU-Rail Scientific Steering Group at the Governing Board meeting on 30 November 2022. The Governing Board will decide on launching a call of expression of interest in the first half of 2023.

The Governing Board was informed about the request to sign a Memorandum of Understanding with RNE at its meeting on 1 March 2022. The Governing Board discussed the content of the Memorandum at its meeting on 24 June 2022 and adopted the text in a non-objection procedure in September 2022.

At its meeting held on 24 June 2022, the Governing Board gave a mandate to the Executive Director to explore the possibilities of new office spaces for the Europe's Rail Joint Undertaking in light of the expiration of the contract with White Atrium's owners in 2024. The Executive Director investigated the possibility of a transfer to the building at Avenue de Cortenbergh, following the departure of SESAR JU. He reported to the Governing Board at its meeting of 30 November 2022 that based on the legal, financial and operational assessment, it was not recommended to move to that building.

The Governing Board was informed at its meeting of 30 November 2022 by the Executive Director about his decision to step down from the position.

The first General Assembly of EU-Rail was also organized on 30 November 2022. According to the Single Basic Act establishing the Joint Undertakings under Horizon Europe, the Governing Board shall meet once a year in a General Assembly and all participants to the research and innovation activities of the Europe's Rail Joint Undertaking shall be invited to attend.

3.3. Executive Director

According to the SBA the Executive Director (ED) is the Chief Executive Officer responsible for the day-to-day management of the JU in accordance with the decisions of its GB and being accountable to the GB. The ED is the legal representative of the Joint Undertaking. He is supported in performing his duties by the Head of Programme, the Head of Corporate Services, the Head of the System Pillar Unit as well as by all JU staff organized in the Programme Office.

2022 saw the consolidation of the ED System and Innovation Programme Board, striving to ensure that barriers experienced in the integration of new concepts in the S2R R&I activities are duly addressed, as well as to ensure that a more encompassing future system architecture would not find obstacles in their integration in the specific R&I projects.

The ED exercising the function in the course of 2022, who was appointed initially in 2016 and whose mandate was renewed in 2021, informed the Governing Board at its meeting held on 30 November 2022 about his decision to step down from the position. Subsequently, based on the respective GB Decision, the EU-Rail Head of Programme was appointed Executive Director ad interim as of 1 March 2023 for a period which should not exceed one year, until the new ED is appointed. The process of recruitment of a new Executive Director will be launched in the course of 2023.

3.4. States Representatives Group

Under the EU-RAIL Programme, 31 countries nominated representatives to the JU's State Representatives Group (SRG).

During 2022, the SRG held four meetings. In addition, three workshops were organised for the SRG dedicated to System Pillar, Innovation Pillar, and the DAC Delivery Programme.

The first meeting of the SRG took place in January 2022. The SRG decided that Ms. Sarah Bittner-Krautsack (Austria) and Mr. Miroslav Haltuf (Czech Republic) would act respectively as Chair and Vice-Chair of the EU-Rail SRG until the formal adoption of SRG Rules of Procedure and organisation of the elections in 2023 in accordance with such Rules of Procedures. The SRG discussed and provided its opinion on the key strategic documents of the Europe's Rail Joint Undertaking: the Master Plan, the Multi-annual Work Programme, and the Consolidated Annual Work Programme. The documents were subsequently adopted by the EU-Rail Governing Board, taking into consideration the opinion of the SRG, in accordance with the provisions of the SBA. The SRG was also informed about the railway-related events organised under the Presidency of the Czech Republic in the Council in 2022.

During its meeting in February 2022, the SRG discussed the SRG Rules of Procedures, which were formally submitted for final written consultation. The SRG decided to extend the interim period of the incumbent Chair and Vice-Chair of the SRG, with elections postponed to 2023. The Chair proposed to organise a small-circle group discussions with new representatives of the Member States and Associated Countries to discuss the priorities of the countries, the expectations, and contributions to the SRG. During the meeting, the SRG also discussed the draft EU-Rail Work Programme, on which they delivered a written opinion in February 2022.

The third meeting of SRG took place in June 2022. The SRG formally adopted their Rules of Procedure. The SRG also discussed the approach to promote coordinated and consistent deployment of technologies in Europe, including the inputs from national investments. The Chair presented the outcome of discussions from the SRG small-circle meetings, discussing the role of the SRG in the EU-Rail activities. The SRG was asked to deliver written comments to the EU-Rail Consolidated Annual Activity Report 2021.

The SRG convened its fourth meeting in September 2022 during the InnoTrans event in Berlin. The SRG discussed the outcomes of the call for proposals HORIZON-ER-JU-2022-01, as well as the possibility of engagement in the System Pillar.

On 25 November 2022, the Chair of SRG, Sarah Bittner-Krautsack, informed the EU-Rail and the SRG about her resignation from the position due to changes in her professional career. Miroslav Haltuf, the SRG Vice-Chair, took up the position of SRG Chair ad interim. The elections to select the new Chair and Vice-Chair of the SRG will be organised in 2023.

During all meetings, participants were informed in detail about the ongoing and planned activities of the JU, including status of the Programme, in particular about the call for proposals HORIZON-ER-JU-2022-01 and its outcome as well as the call HORIZON-ER-JU-2022-02. They were updated on the System Pillar, the European DAC delivery programme, and the communication and dissemination activities of the Europe's Rail.

3.5. Scientific Committee

The Scientific Committee (SC) is an advisory body to the JU focusing on the long-term research and on identifying scientific and technological achievements and development priorities.

The JU GB decisions on the selection of the SC members (GB - 03/2015, GB -15/2016, GB-10/2017, and GB-06/2019) have been readopted by the EU-Rail Governing Board by means of the "Omnibus decision", allowing for continuation of the incumbent Scientific Committee under the Europe's Rail Programme until the Governing Board would take a decision on the type of scientific advice for the JU and launch procedure for establishment of a new body.

In 2022 the Scientific Committee convened four meetings.

The first meeting of the SC under the Europe's Rail programme took place in February 2022. The Committee discussed the draft Work Programme 2022-2024, which was subject to adoption by the Governing Board at its meeting in March 2022. The Members of the SC exchanged their comments and views in light of the presented draft Programme. The formal opinion of the Scientific Committee was requested in a written procedure in February 2022.

The second meeting was organised in July 2022. The Members of the SC discussed the amendment to the Europe's Rail Work Programme 2022-2024. In particular, they discussed the topics proposed for the second

call for proposals. The Committee also discussed the new type of scientific advice under the Europe's Rail and the members exchanged their ideas. In particular, they focused the discussion on the topic dedicated to building a network of the rail scientific and research community, including funding for PhD programmes.

The third meeting took place in September 2022 during the InnoTrans in Berlin. The Members of the SC discussed the outcomes of the first call for proposals, including the list of proposals to be invited to the grant preparation phase, as well as the second call for proposals, launched on 13 September 2022. The Committee continued the discussion on the proposal for new type of scientific advice under the Europe's Rail Programme, including the prospects for the JU to launch a call for expression of interest to select the members of the new body.

The Scientific Committee gathered for its fifth meeting in November 2022. The Executive Director presented the concept paper on the establishment of the Scientific Steering Group in accordance with provisions of the Single Basic Act. The Members of the SC supported the concept paper and exchanged their opinions. The Committee also discussed the amendment to the Work Programme 2022-2024 including the IKAA plans provided by the JU Private Members. The Members of the SC were requested to provide in writing their scientific opinion on the subject matter.

The Members of the Scientific Committee were informed on a regular basis of the developments in the Europe's Rail Programme, including the launch of the calls for proposals, the status of the System Pillar, the progress in DAC delivery programme, and the communication and dissemination activities of the JU.

3.6. Deployment Group

As per Article 97 of the Single Basic Act, the Deployment Group is to advise the Governing Board on the market uptake of rail innovation developed in EU-Rail and to support the deployment of innovative solutions.

The Deployment Group shall be open to all stakeholders. The composition of the Deployment Group shall ensure appropriate thematic focus and representativeness. The Commission shall take the final decision on the composition of the Group. The list of members shall be published on the website of the Europe's Rail Joint Undertaking.

The Deployment Group shall provide recommendations on issues related to the deployment of rail innovative solutions upon request of the Governing Board. The Deployment Group may also issue recommendations on its own initiative.

During 2022, the focus was on the setup System Pillar and Innovation Pillar programme and structure. Pending their initial results, the launch of the Deployment Group is foreseen in 2023.

3.7. System Pillar Steering Group

As per SBA Article 96, the System Pillar Steering Group (SPSG) is responsible for providing advice to the Executive Director and the Governing Board on:

- the approach to operational harmonisation and the development of system architecture,
- the detailed annual implementation plan for the System Pillar in line with the work programmes adopted by the Governing Board,
- monitoring the progress of the System Pillar.

Domain Teams and Core Group are preparing decisions to be validated at the System Pillar Steering Group and Governing Board levels.

The SPSG is composed of the following members:

- Chair: DG MOVE
- Members: Commission (DG MOVE and DG RTD), EU-Rail, Chairperson of the States Representative Group, ERA, ERRAC, AllRail, CER, EIM, UNIFE, UITP, UIP
- Observers (technical bodies responsible for providing advice to members): EUG, UIC, UNISIG, UNITEL
- Observers (other): ERTMS Coordinator, EPF, EUSPA, ETF, NB-Rail, RNE

In 2022 three SPSG meetings took place. On the first meeting held on 12 May the Rules of Procedures were presented and adopted. Furthermore, the Steering Group agreed on the proposed governance structure by consensus after procedural questions had been discussed and clarified. In order to allow for sector input, the SPSG agreed on the concept of guided workshops, organised in working cycles.

The second Steering Group meeting took place on 29 September 2022. The System Pillar Common Business Objectives (CBO) were presented and adopted by consensus. The CBO will serve as a guide for the decision-making process in the System Pillar and inform the development of the operational work. Members were informed about the final version of the Governance and Process Handbook and that meetings between the Flagship Projects and the System Pillar took place for alignment. Furthermore, the CCS/TMS/CMS operational vision was adopted.

The third 2022 SPSG meeting took place on 28 November. The Steering Group was joined by the representatives of ETSI in the role of observers in order to ensure alignment. The importance of openness and transparency of the System Pillar was stressed, and, in line with this requirement, the creation of a dedicated webpage was presented. After a discussion the System Engineering Management Plan (SEMP) was endorsed. In addition, it was decided that the SPSG will further consider ways to involve the research community in the work of the System Pillar.

3.8. Innovation Programme's Steering Committees (SteCos)

The JU Programme Office convened regular IPs and CCA SteCos meetings (four per each IP/CCA in 2022, in total 24 meetings) accordingly to the IPs/CCA Rules of Procedure. The aim of these meetings was to ensure the necessary coordination of activities within each IP/CCA and to provide input in assisting the JU in the monitoring of the Programme activities, notably ensuring the Demonstrations activities planning, especially in view of the closing of the S2R programme in 2023 and coordinated dissemination and communication activities. The coordinators of the CFM and OC projects were invited to participate to the SteCo meetings in order to present the progress of their works in a way to ensure coordination of actions and to maximise synergies among projects.

3.9. European Union Agency for Railways (ERA)

Both the S2R Statutes, and as of 30 November 2021 the SBA for EU-Rail, provide for a collaboration between the JU and ERA. In this respect, the rules of procedures of all relevant groups/bodies established under the JU foresee the participation of representatives from ERA (either as observers or their direct members). This ensures that the Agency is duly prepared to take into account the results of the Programme in its activities.

As a result, staff members of ERA have been participating in meetings of the JU's GB, SRG, SP-STG, Scientific Committee, and the IP/CCA SteCos. Due to participation in the work of these bodies, the representatives of ERA had access and contributed to the draft documents in preparatory work for establishment of the Europe's Rail Joint Undertaking. Additionally, ERA are members of the System Pillar Core Group.

The JU's Governance and Process Handbook⁵⁷ clarifies the way ERA can access the R&I activities performed within the S2R Programme in the areas of their competence, interoperability and safety.

It is worth mentioning that the JU provided to ERA in 2018 the ATO over ETCS GoA2 specification and in 2019 the Moving Block (MB) system specification, MB operational and engineering rules as well as the MB preliminary safety analysis, all as input of the possible game changers integration in the next release of the CCS TSI. The work on the preparation of the update of the ERTMS/ETCS specifications for the TSI 2023 update was continuing in 2022, with input from EU-RAIL as well as on the train architecture, a steppingstone to the work to be performed by the System Pillar.

Through the S2R Framework Contract to support the ERTMS Deployment action, the JU had issued service contracts formulated with ERA and the European Commission for the maintenance of the ERTMS specifications as well addressing the technical updates for integration of the game changers into the

⁵⁷ <https://rail-research.europa.eu/wp-content/uploads/2023/01/EU-Rail-Governance-and-Process-Handbook.pdf>

regulation by the ERTMS system authority. This framework contract has ended at the end of 2022. The activities related to ERTMS, and maintenance of the activities, are handled by the System Pillar.

In addition, regular coordination meetings have been organised between the two EDs, operational staff and communication staff. The overall objective is to ensure that the R&I innovative solutions that will be delivered by the S2R Programme will be considered in the pipeline of ERA activities in order to avoid any step back in the future market uptake.

The role of ERA in the context of 4th Railway Package, is another asset to facilitate the deployment of the S2R Innovative Solutions.

In addition, with the objective to avoid overlapping activities, EU-Rail assesses the requests for R&I coming from ERA and ensure their implementation to maximize the use of public funding. Building upon parallel structures would constitute a waste of resources.

The JU participates together with ERA to the Rail Standardisation Coordination Platform for Europe (RASCOP) chaired by the European Commission (DG Move). In 2022, via the ad hoc working group on the Commission Standardisation request, EU-Rail continued to provide its input in consultation with ERA and with the relevant European standardisation organisations. The JU identified the specific areas and activities which can provide input to harmonised standards to be reviewed in the next 5 years.

EU-Rail has also ensured along the year the contribution of its projects to ERA Topical Working Groups in view of the revision of the TSIs 2023 Package; such important work is paramount to accelerate the market uptake of the innovative solutions.

4. FINANCIAL MANAGEMENT AND INTERNAL CONTROL

4.1. Effectiveness of controls

4.1.1. Legality and regularity of the financial transactions

EU-Rail uses internal control processes to ensure sound management of risks relating to the legality and regularity of the underlying transactions it is responsible for, taking into account the multiannual character of programmes and the nature of the payments concerned.

The current JU Financial Rules were adopted on 20 December 2019 by its Governing Board (Decision N°11/2019) and entered into force on 1 January 2020. By means of these amended Financial Rules, the framework for the JU's financial procedures reflected the applicable version of the General EU Financial Regulation 2018/1046 which entered into force on 18 July 2018. As per this legal framework, the JU's financial procedures are designed in a manner allowing compliance with the principle of sound financial management.

As it was under the S2R JU, with EU-Rail becoming operational as of 30 November 2021, the JU continued to comply with the provisions of the applicable Model Financial Regulation. Any future departure from this Model Financial Regulation, as potentially required for the purpose of the Joint Undertaking's specific needs, shall be subject to the Commission's prior consent.

With regard to ICT tools applied to support its financial procedures, since 2016, the JU has utilized ABAC Workflow (accounting system of the European Commission). During the past years, the processes have been further reinforced with the introduction of the JU Cooperation Tool (including for in-kind contribution declarations and certifications) and the implementation of ICT tool ABAC Assets.

At the time of deployment of ABAC Workflow as mentioned above, the JU adopted its Manual of Financial Procedures including the applicable Financial Circuits. This Manual of Financial Procedures was lastly revised in February 2023. It has been designed to guarantee a segregation of duties and to apply the four eyes principle in JU's financial transactions. In this respect, the initiation of a financial transaction and its verification are performed by different actors (ABAC users). Furthermore, the document describes in detail the financial circuits the JU implements per type of transactions and the roles and responsibilities of each actor involved in the implementation of its budget. To a lesser extent, it also describes the basic principles of main procedures (grants & procurements).

As for the JU budget it comprises in principle two main types of expenditure:

- Administrative Expenditure covering both Titles 1 and 2 of the Budget, and
- Operational Expenditure covering Title 3 (for the S2R Programme) and Title 4 (for the EU-Rail Programme) of the Budget.

The Title 5 is dedicated to account for unused appropriations.

Due to their nature and the difference in ICT tools implemented at the JU to manage them, the financial circuits for these two expenditure types are different.

It should be noted that in addition to the JU-specific methodological framework for financial procedures, common rules of the R&I Family (Vademecum) established for the Horizon 2020 and for Horizon Europe are applied by EU-Rail as well.

With regard to the accounting services, a significant change took place in 2022. In particular, with the exception of the treasury function, the Accounting Officer of the Commission ceased their services for EU-Rail and these were taken over by the JU's newly appointed Accounting Officer within the framework of the common back office arrangements (BOA) established among the Joint Undertakings. Moreover, in line with the provisions of the respective Service Level Agreement, EU-Rail took the role of the lead JU for the accounting part of the BOA and started acting as one of the three accounting service providers (complemented in this role by CA JU and SESAR JU) under the SLA. For more information about synergies among JUs, please refer to the section 2.7.2 "Efficiency gains and synergies", of the present document.

Ex-ante Controls on operational Expenditure

In 2022, the JU continued to follow the procedures for ex-ante controls defined internally (JU Financial Rules) as well as the common Horizon 2020 / Horizon Europe ex-ante control framework.

EU-Rail has followed the Article 21(1) of its Financial Rules providing that “each operation shall be subject at least to an ex-ante control relating to the operational and financial aspects of the operation, on the basis of a multiannual control strategy which takes risk into account”. The ex-ante controls are considered essential to prevent errors and to avoid the need for ex-post corrective actions. They take the form of checking contracts and grant agreements, initiating, checking and verifying invoices and cost claims and carrying out desk reviews (such as mid-term reviews carried out by external experts on JU's projects and other).

The JU applied standard financial circuits in ABAC Workflow for the commitments and payments. The circuit has a three-step authorisation performed by the following financial actors:

- Initiating Agent (OIA and FIA)
- Verifying Agent (OVA and FVA) and
- Authorising Officer (AO).

Staff members designated by the AO to verify financial operations are chosen on the grounds of their knowledge, skills, and appropriate professional experience.

The JU financial circuits comply with the requirements of the four eyes principle, segregation of duties and the independence of the verifier. At the same time, they allow also for the necessary flexibility to ensure the continuity of operations, with regard to limitations in the number of staff. The fact that the Head of Programme was appointed the ED ad interim as of 1 March 2023, thus becoming the AO, was reflected in the financial circuits by means of amendment to the JU's Manual of Financial Procedures introduced in February 2023.

For the operational expenditure, the JU recognises two different types of transactions: the ones solely performed in the ABAC Workflow and the ones with the initiation and verification functions outside of the ABAC environment - in the SyGMA tool. This tool is also linked to ABAC which allows real time controls over the budget and its implementation.

The particular system where the initiation and verification are to be performed is derived from the nature of the transaction, as follows:

- ABAC for all procurement related transactions, and
- SyGMA for any transactions related to grant management.

However, in all transactions, irrespective of whether initiated in SyGMA or ABAC, the AO will always give his/her authorisation in ABAC only.

A key element of the ex-ante controls is the “*Guidance Horizon 2020 ex-ante controls on interim & final payments*” adopted by the CSC Steering Board on 15 Dec 2016 and applicable as such to the JU. As a consequence of the approach introduced in this guidance, simplified ex-ante controls are applied. In particular, the level of details asked from the beneficiaries to be provided in each periodic report is limited, allowing the JU to check a limited number of conditions regarding the eligibility of costs. Ex-ante controls in Horizon 2020 are therefore trust-based, focusing on whether:

- the work has been done (as described in the periodic reports),
- the reported effort and use of resources are reasonable and in accordance with the plan,
- sufficient explanation and justification are provided for any substantial deviations.

In practice, the assessment involves comparing the Description of the Action (DoA) and the budget earmarked with the work actually carried out, as per explanation provided in the periodic report, and with the costs being claimed by the beneficiaries in connection with it.

Certain elements (such as risk factors or deviations) are scrutinized to a lower extent when checking interim periodic reports when compared to assessing final reports. Moreover, since CFS are required only as part of the final reports, ex-ante controls in final periods are more in-depth. In addition, officers may take a more flexible approach to ex-ante controls in interim periods by asking beneficiaries for additional clarification in the ensuing reporting period. However, by the time the final payment is made, all outstanding issues should have been dealt with.

EU-Rail also applies for the actions falling under its current Programme the common guidelines for Horizon Europe, such as the "HE Ex ante controls" or "HE Ex ante anti-fraud checks" guidelines. The HE ex ante controls developed in these guidelines build upon the principles and practices adopted under H2020 with enhancements based on lessons learnt. It combines a pre-defined set of simple and straight-forward standard controls with additional risk-based checks that are triggered when specific risks are detected. The main principles of the common HE ex ante control strategy are:

- Controls must provide reasonable assurance about legality and regularity, based on the information available at the time;
- Controls must strike the right balance between reducing the administrative burden and exercising effective financial control;
- Controls must be risk-based and cost-effective;
- Beneficiaries should be treated equally.

Ex-post controls of operational expenditure and error rates identified

Ex-post controls are defined as the controls executed to verify the financial and operational aspects of finalised budgetary transactions in accordance with Article 22 of the JU Financial Rules. The main objectives of the ex-post controls are to ensure that the principles of legality, regularity, and sound financial management (economy, efficiency and effectiveness) have been respected and to provide the basis for corrective and recovery activities, if necessary.

The controls are the last stage of the JU's control strategy in the project life cycle. This stage includes the ex-post audits as well as the recovery/correction of any amounts found to have been paid in excess of the sum eligible.

Ex-post controls of operational expenditure at EU-Rail are covered by the Horizon 2020 Audit Strategy. The implementation of the Horizon 2020 Audit Strategy falls under the responsibility of the Common Audit Service (CAS) of the Commission. The role of the CAS is defined in the Commission Decision "C(2014) 2656 final" on the operating rules for the Common Support Centre for Horizon 2020, the Framework Programme for Research and Innovation (2014-2020)⁵⁸. As follows from this Decision "The Common audit service shall contribute to assessing the legality and regularity of Horizon 2020 project payments by means of ex-post financial controls carried out, either by its own auditors or by independent audit firms in accordance with the decisions of the Steering Board. It shall provide the relevant Authorising Officers by Delegation (AODs) with necessary elements of assurance on the research budget for which they are responsible."⁵⁹

The main actions identified to realise the objectives following from the Horizon 2020 Audit Strategy include:

- the gradual achievement, in a cost-effective way, of quantitative multi-annual targets in terms of audited participations⁶⁰;
- the closure and communication of audit findings and extension of audit findings to those responsible for their implementation providing the basis for corrective and recovery activities, if necessary.

For Horizon 2020, the CAS carries out all audits, including those concerning grants concluded by the Executive Agencies and the Joint Undertakings. This is a major step towards ensuring a harmonised approach, legal certainty, equality of treatment and minimising the audit burden on beneficiaries.

⁵⁸ [https://ec.europa.eu/transparency/documents-register/detail?ref=C\(2014\)2656&lang=en](https://ec.europa.eu/transparency/documents-register/detail?ref=C(2014)2656&lang=en)

⁵⁹ In principle, the same mandate of the CAS applies also for the Horizon Europe Framework Programme as defined in Article 23 of the Commission Decision C(2021) 4472 final.

⁶⁰ A participation is the combination of a beneficiary and an action. An audit can cover more than one participation.

The main indicators on legality and regularity of EU Framework Programmes for Research and Innovation are:

- **Cumulative representative detected error rate**, based on errors detected by ex-post audits on a Common Representative Sample of cost claims across the R&I Family.
- **Cumulative residual error rate**, which is the extrapolated level of error after corrective measures have been implemented by the respective services following the audits, accumulated on a multi-annual basis.

The target set for Horizon 2020 is to ensure that the cumulative residual error rate remains within a range of 2-5 % aiming to be as close as possible to 2%.

Progress against Horizon 2020 targets is assessed annually based on the results of the implementation of the ex-post Audit Strategy and taking into account the frequency and importance of the detected errors along with cost-benefit considerations regarding the effort and resources needed to detect and correct the errors.

It should be noted, however, that due to its multi-annual nature, the effectiveness of the control strategy of the R&I Family can only be measured and assessed fully in the final stages of the EU Framework Programme, once the ex-post audit strategy has been fully implemented, and errors, including those of a systematic nature, have been detected and corrected.

The Horizon Europe Audit Strategy will be based on the achievements and lessons learnt from H2020 and will be risk-based. A concept paper was drafted in December 2022 by the CAS providing key concepts in this respect and representing the starting point for further elaboration of the strategy.

The target set for Horizon Europe will be to ensure that the cumulative residual error rate does not exceed 2%⁶¹.

However, as EU-Rail will be applying lump sum form of grants under the Horizon Europe Programme, and since such grants cannot in principle be subject to financial type of ex-post audits conducted by the CAS, the JU intends to establish a framework for conducting reviews/audits focused more on the qualitative (technical) aspects of implementation of such grants.

Ex-post controls of the Horizon 2020 programme globally in 2022

In 2020, the Commission refined its methodology for calculating the Horizon 2020 error rates in line with the European Court of Auditors' observations in its 2018 and 2019 Annual Reports⁶². As of January 2020, DG R&I applied the revised methodology on a sample of 1.937 audit conclusions. This resulted in the following error rates for Horizon 2020⁶³ as of 31 December 2022:

- Cumulative representative detected error rate: 2,71%⁶⁴,
- Cumulative residual error rate for the Research and Innovation Family DGs: 1,67% (1,71 % for DG Research and Innovation⁶⁵).

These error rates are calculated on the basis of the audit results available when drafting the Consolidated Annual Activity Report. They should be treated with caution as they may change subject to the availability of additional data from audit results.

⁶¹ No representative error rate for Horizon Europe will be available in 2022 and 2023 as the ex-post audit campaign for the Programme is planned to be launched by the end of 2023, at the earliest.

⁶² When calculating the multi-annual error rate, the Commission took into account the results of the audit re-performed by the ECA as part of Module 2 of the DAS 2018-2019.

⁶³ The Horizon 2020 audit campaign started in 2016. At this stage, four Common Representative Samples with a total of 628 expected results have been selected. By the end of 2022, cost claims amounting to EUR 40.8 billion have been submitted by the beneficiaries to the services. In addition to the Common Representative Samples, Common Risk Samples and Additional Samples have also been selected. The audits of 4.060 participations were finalised by 31/12/2022 (of which 633 in 2022).

⁶⁴ Based on the 479 representative results out of the 628 expected in the four Common Representative Samples.

⁶⁵ It should be noted that in 2021 most H2020 grants managed by DG R&I were transferred to Executive Agencies. Hence, this figure is based only on the actions that remained with DG R&I at the end of 2021.

Since Horizon 2020 is a multi-annual programme, the error rates, and the residual error rate in particular, should be considered within a time perspective. Specifically, the cleaning effect of audits will tend to increase the difference between the representative detected error rate and the cumulative residual error rate, with the latter finishing at a lower value.

Given the results of the audit campaign, and the observations made by the European Court of Auditors in its Annual Reports, the Common Implementation Centre, in close cooperation with central Commission services, defined actions aimed at significantly simplifying the rules and paving the way for a significant reduction of the error rate in Horizon Europe. Actions were undertaken including further simplification, increased use of simplified forms of funding (including lump sums and unit costs), focused communication campaigns to more “error-prone” types of beneficiaries with higher-than-average error rates, such as SMEs and newcomers, and enhanced training to external audit firms performing audits on behalf of the Commission. Focusing on the most common errors, these events will be straightforward, reaching more participants and achieving higher impact.

Horizon Europe Framework Programme

2022 was the second year of implementation of the Horizon Europe framework programme. No representative error rate for Horizon Europe is available for 2022 as the ex-post audit campaign for the Programme is planned to be launched by the end of 2023 at the earliest, once a meaningful number of payments can be audited.

Ex-post controls 2022: EU-Rail specific sample

The number of ex-post audits of EU-Rail participations carried out by the CAS until year end 2022 corresponds to the relatively small share of the JU's budget (less than 1%) in relation to the overall H2020 budget. However, the JU in cooperation with the CAS continuously strive for ensuring on an ongoing basis sufficient ex-post audit coverage allowing to provide the respective reasonable assurance to the EU-Rail Executive Director to support his declaration of assurance, also in light of the discharge procedure.

2022, being the sixth year of the H2020 audit campaign, was still marked for the CAS with the effects of the Covid-19 pandemic, which adversely influenced the execution of the ex-post audits in 2020 and 2021, and created a backlog reflected in the reduced number of new sample selections for the 2022 target (9 participations in the case of EU-Rail). Nevertheless, the CAS managed to close 12 ex-post audits of EU-Rail participations in 2022, as was anticipated in the most probable scenario.

For the same reasons, when setting the sampling parameters for the 2022 selection of new audits to become part of the 2023 target, a reduction was foreseen by the number of participations selected in the past that were at that time not expected to be closed by the end of 2022 according to the most probable scenario. In particular, it was set for EU-Rail that five new participations should be selected to complement the eight to be carried over from 2022 due to the backlog. Indeed, after the sampling exercise, the CAS confirmed in September 2022 the selection of the EU-Rail participations counting towards its 2023 local representative audit target, covering 5 participations/7 reporting periods.

As of 31 December 2022, total cumulative cost claims related to projects managed by EU-Rail, hence representing its auditable population, reached the amount of EUR 224.304.553,24 for 87 projects. As for the amount of cost claims actually audited by the end of 2022, it was EUR 14.449.166,57 representing the direct EU-Rail audit coverage of 6,44%. The indirect coverage, i.e. the total directly non-audited cost claims of all audited EU-Rail beneficiaries amounted to EUR 151.474.404,41 (67,53%).

The overall status for H2020 ex-post audits related to the JU projects as of yearend 2022 is shown below⁶⁶.

Number of participations for which audits were launched during individual years (risk-based audits not included):

⁶⁶ As per the data files provided by the CAS.

GROUP	Total Launch 2017	Total Launch 2018	Total Launch 2019	Total Launch 2020	Total Launch 2021	Total Launch 2022	Launch Total	Sched Total	Open Total	Sched + Open + Closed Total
EU-RAIL	16	17	12	39	13	5	102	0	12	102

H2020 - CAS - PARTICIPATIONS CLOSED PER CLIENT - OVERALL VIEW - TOP-UPS and ECA JOINT AUDITS INCLUDED

Framework	Domain	Client	Closed 2016	Closed 2017	Closed 2018	Closed 2019	Closed 2020	Closed 2021	Closed 2022	Closed Total
H2020	CAS	EU-RAIL	0	0	4	22	22	30	12	90

Number of participations subject to top-ups/risk-based audits:

Entity	CRS4				CORP RISK				Counts Towards LOCAL RISK TARGET	LOCAL RISK 2022 SCHED	LOCAL RISK 2022 OPEN	LOCAL RISK 2022 CLOSED
	SCHED	OPEN	CLOSED		2022-03 SCHED	2022-03 OPEN	2022-03 CLOSED					
EU-RAIL									1		1	

Overview of cost claim figures related to the JU projects as of 31/12/2022:

Total number of validated cost claims	2177
Total cost accepted by JU (cumulative) (A)	224.304.553,24
Total cost audited by the end of 2022 (B)	14.449.166,57
Total not directly audited cost claimed by audited JU's beneficiaries (C)	151.474.404,41
Direct audit coverage ratio (B / A)	6,44%
In-direct audit coverage ratio (C / A)	67,53%

As of 31 December 2022, 76 final audit reports from ended ex-post audits covering the JU's projects were available.

Overall detected error rate based on 92 participations: by applying simple average is 2,54% and by applying weighted average is 2,21%.

Representative Error Rate based on 88 participations: by applying simple average is 2,58% and by applying weighted average 2,22%.

EU-Rail Residual Error Rate: by applying simple average is 1,25% and by applying weighted average is 1,27%.

As at the cut-off date 31.12.2022, **the JU's H2020 cumulative residual error rate is below the targeted threshold of 2%**⁶⁷ under both methodologies - the simple and the weighted average.

4.1.2. Fraud prevention, detection, and correction

Early July 2022, EU-Rail adopted its new Anti-Fraud Strategy for 2022-2025⁶⁸ which replaced the previous one initially introduced in 2017. The adoption was preceded by a thorough specific fraud risk assessment. Part of this assessment, in particular the one pertaining to the fraud risks in grant management, was conducted commonly at the level of the entire Family of the EU Research & Innovation Services, Agencies

⁶⁷ See Annex I for materiality criteria regarding the error rate.

⁶⁸ https://rail-research.europa.eu/wp-content/uploads/2022/07/ED-DECISION_ED-22-02_Anti-Fraud-Strategy-2022-2025_Annex_AFS.pdf

and Joint Undertakings (Research Family) and steered by DG RTD. This was complemented at EU-Rail level with the assessment of other risks of fraud, such as those related to procurement, recruitment, misuse of internal information, misuse of JU's reimbursement schemes, etc.

By means of its current Anti-Fraud Strategy, similarly to the previous one, EU-Rail will continue to cover, to the applicable extent, all four elements of the anti-fraud cycle, namely: prevention, detection, support to investigation and correction.

The main anti-fraud objectives of the JU for the period of 2022-2025 are the following:

- 1) keeping the JU's internal legal framework related to anti-fraud policy up to date,
- 2) fostering an anti-fraud culture throughout the organisation,
- 3) maintaining a high level of awareness and knowledge among the staff members on the subject matter,
- 4) ensuring high level of reactivity towards OLAF/EPPO,
- 5) preventing the misuse of internal information/data.

These objectives are pursued by means of particular measures and actions, as listed in the below action plan. The actions are subject to follow-up and to assessments regarding potential updates conducted, as a minimum, once a year. For 2022, the follow-up of anti-fraud actions brought the following outcomes:

	Action	Follow-up on the action plan for 2022
1	The EU-Rail management strives for ensuring the appropriate overall anti-fraud culture throughout the organisation and sets the tone at the top by conveying messages to staff on the subject matter stressing the importance of acting according to the highest professional and ethical standards.	3 communications dedicated to fraud prevention and ethics were provided to EU-Rail staff from the Executive Director.
2	The EU-Rail bodies are informed about the JU's anti-fraud policy and its practical application and their members are reminded of their duties related to the subject matter, most importantly on the obligation of reporting any conflicts of interests.	A dedicated presentation of the new EU-Rail Anti-Fraud Strategy was made in the EU-Rail GB meeting held on 30/11/2022. Several other written communications were provided to the EU-Rail GB members and observers, including reminders on submitting declarations of interests.
3	The EU-Rail internal legal framework related to the anti-fraud matters is regularly reviewed in order to keep it up to date and complete.	A review was performed.
4	The EU-Rail staff members are regularly provided with information and updates with regard to anti-fraud matters by means of a dedicated section on the JU's intranet.	A separate intranet page dedicated to the topic of anti-fraud and ethics was created. A comprehensive repository of files related to anti-fraud was maintained and made available to staff on the intranet (SharePoint)
5	Regular information sessions and trainings are organised for EU-Rail staff on the subjects of anti-fraud and ethics.	An anti-fraud training was held. A dedicated training on ethics was held. A workshop was organised by DG RTD for JUs' staff on the Horizon Europe guidance on ex-ante checks to detect potential fraud.
6	Ensure comprehensive and timely cooperation with the respective EU bodies (OLAF, EPPO) and swift provision of requested information and documents in cases of investigations or other activities with regard to potential fraud.	No case occurred at EU-Rail requiring reporting to OLAF/EPPO. Cooperation with the OLAF correspondent was used when drafting the new EU-Rail Anti-Fraud Strategy and with regard to the

	Action	Follow-up on the action plan for 2022
		revision of the EU-Rail internal legal framework.
7	Ensure appropriate follow-up and the necessary action based on the results of OLAF's/EPPO's investigations and other activities by means of recovery of the concerned amount of funds, application of administrative sanctions and other measures.	No case investigated by OLAF/EPPO occurred requiring follow-up actions by EU-Rail.
8	Participate in the Research Family anti-fraud activities by contributing to common discussions, outputs and documents. Utilising of the knowledge shared within the Research Family in JU's internal anti-fraud documents, activities and trainings.	<p>EU-Rail participated in the FAIR Committee meetings held in 2022 and actively contributed to the common R&I Family activities, such as the fraud risk assessment for grants or drafting of the HE Guidance on ex-ante anti-fraud checks.</p> <p>The relevant R&I Family inputs and documents were reflected in drafting of the new EU-Rail Anti-Fraud Strategy as well as in the trainings provided to EU-Rail staff.</p>
9	Ensure an appropriate level of cooperation with the parent Commission Service – DG MOVE.	<p>DG MOVE was consulted when drafting the new EU-Rail Anti-Fraud Strategy.</p> <p>EU-Rail representative participated in the webinar on fraud prevention organised by DG MOVE.</p> <p>Exchanges with DG MOVE took place with regard to risk assessment.</p>

In accordance with the current EU-Rail Anti-Fraud Strategy, and in line with agreement on usage of common indicators within the Research Family, the below indicators with regard to the results of fraud prevention/detection/correction activities are reported as at year end 2022:

	Indicator	Result for 2022
1	Number of messages/communications on anti-fraud matters addressed to the staff by the Executive Director.	3 communications dedicated to fraud prevention and ethics were provided to EU-Rail staff from the Executive Director.
2	Number of information on anti-fraud matters communicated to the EU-Rail Governing Board and other JU bodies, as applicable.	1 dedicated presentation in the EU-Rail GB meeting. 3 written communications to the EU-Rail GB members and observers.
3	Number and value of contracts subject to close monitoring or additional controls due to an assessment of a high risk of fraud.	0
4	New cases sent to OLAF and opened in the respective year, and cases handled by OLAF relevant to EU-Rail in that year.	0
5	Timeliness and completeness of JU's implementation of financial recommendations received from OLAF.	No recommendations were received from OLAF.
6	Time elapsed between OLAF requests for information and date when the information is provided to OLAF.	No requests for information were received from OLAF.

	Indicator	Result for 2022
7	Number and content of performed trainings and other activities aimed at awareness-raising of the EU-Rail staff.	<p>An anti-fraud training was held.</p> <p>A dedicated training on ethics was held.</p> <p>A workshop was organised by DG RTD for JUs' staff on the Horizon Europe guidance on ex-ante checks to detect potential fraud.</p>
8	Number of cooperative activities in the field of anti-fraud policy with relevant stakeholders (e.g. FAIR Committee, other JUs) to which representatives of EU-Rail participated and contributed to.	<p>EU-Rail participated in the 2 FAIR Committee meetings held in 2022.</p> <p>EU-Rail actively contributed to the common R&I Family fraud risk assessment for grants.</p> <p>EU-Rail actively contributed to the drafting of the HE Guidance on ex-ante checks to detect potential fraud.</p> <p>The JU consulted DG MOVE when drafting the new EU-Rail Anti-Fraud Strategy.</p> <p>EU-Rail representative participated in the webinar on fraud prevention organised by DG MOVE.</p>

4.1.3. Assets and information, reliability of reporting

EU-Rail continued in 2022 to apply various measures and control activities in order to safeguard its assets and information.

In that respect and to protect EU public funds from potential irregular or illegal application, EU-Rail thoroughly applies within the grant and procurement management all the requirements regarding controls and checks following from the applicable legal framework as well as from the common methodological guidance provided by the Commission. These are complemented, where deemed necessary, by additional internal guidelines and manuals application of which is then reflected in the day-to-day conduct of control activities at the JU. Apart from various ex-ante and ex-post controls, continuous monitoring is ensured with regard to the implementation of the JU's budget, to operational and administrative payments and to the JU Members' reporting of their in-kind contributions/total project costs. Follow-up is conducted with particular beneficiaries to JU's grants, if the financial ex-post audits performed by the CAS reveal systemic or recurrent errors indicating deficiencies in beneficiaries' control systems.

In addition to the safeguards aimed at financial aspects, EU-Rail pays attention also to non-financial elements of its assets and information. Due care is taken with regard to personal data protection (see Section 2.8). For example, a comprehensive Data Protection Impact Assessment was carried out in connection with the Microsoft Office Online services implementation, results of which were properly documented. Measures are applied for the deployed IT tools and IT infrastructure so that information processed electronically is adequately protected from theft or loss. Similarly, measures for physical protection of assets, documents and data contained therein are in place at the EU-Rail premises. Awareness-raising activities are held regularly for the benefit of the JU's staff to draw their attention to the importance of protection of assets and information, especially with regard to phishing, being still the most common way how intruders from the external environment seek their way to gain unauthorised access to non-public data. A comprehensive Document Management Policy is applied at the JU which is formalised by means of the respective ED Decision.

As is described in more details in other parts of Chapter 4 of this CAAR, no material issues were detected in 2022 at EU-Rail in terms of inadequate safeguarding of assets or information neither in the audits conducted by the ECA/IAS, nor by the comprehensive self-assessment of the EU-Rail internal control system. No case of exception or non-compliance event of this kind occurred in 2022.

As for reliability of reporting, EU-Rail continuously strives for utilising precise and up-to-date information for reporting purposes, most notably for the production of its consolidated annual activity reports. In this respect, for many sets of data, especially in the field of grant management, the IT tools and systems owned by the Commission and deployed also by EU-Rail (Compass, SyGMA, Corda) are used as the primary source. These are further complemented by internal tools, databases and repositories maintained by the respective staff members. Possibilities for improvements in internal data processing and record-keeping are considered on an ongoing basis. Attention is paid to maintaining audit trail so that the reported data can be traced back to its initial source, as necessary, mostly by means of registering files in Ares.

4.2. Efficiency of controls

Similarly to other EU services and bodies, EU-Rail, as follows from its Financial Rules, is subject to requirements pertaining to the efficiency of controls and checks applied in the grant agreement management and, as applicable, in management of other types of contracts and agreements. This means that the JU should on one hand ensure due diligence in performing the necessary checks ensuring the sound financial management, but at the same time, meet the set time limits for certain milestones in the preparation of, or during the lifetime of the grant/contract. Such time limits are referred to as:

- “time to inform” – i.e. the time elapsed from the submission of complete proposal to the moment of informing the applicant on the evaluation outcome (should not be longer than 6 months),
- “time to sign/grant” – i.e. the time elapsed from informing the successful applicant on the results of the call evaluation to the moment of signing of the grant agreement (should not be longer than 3 months),
- “time to pay” – representing different time limits for making the respective payment to the counterparty, being 90 calendar days maximum in case grants-related payments.

EU-Rail uses various monitoring tools in order to comply with the above-mentioned time limits.

The average values of the “time to” indicators applicable to all JU’s grants are included in Annex E, Table I of this CAAR.

It can be concluded that despite the ad hoc accumulation of workload in certain periods of the year and the fact that in the course of 2022 there were still some posts not filled, the JU managed on average to meet the deadlines represented by the “time to” indicators. However, due to having exceptionally two calls for proposals in 2022, some reporting and payment workflows which would have been normally dealt with still in 2022 were shifted in a planned manner to 2023, as preference needed to be given to evaluation of proposals and preparation of new grant agreements in Q4 2022. This might reflect in the “time to pay” indicator to be reported in the 2023 CAAR.

4.3. Economy of controls

This section provides information about the JU’s cost of the controls applied in connection with grant management and procurements⁶⁹.

JU’s resources dedicated to ex-ante controls in connection to grants:

Stage of the control	Description	Year			
		2021		2022	
		EUR	FTE	EUR	FTE
Stage 1 – Programming, evaluation and selection	Cost of programming + evaluating + selecting / value contracted	84.600	1	107.200	1,1
Stage 2 – Contracting including financial commitments,	Cost of controls related to the contracting / amount paid	38.700	0,5	45.300	0,5

⁶⁹ The information presented in this CAAR Section corresponds with data reported to DG MOVE with respect to cost of control.

guarantees,...) and legal checks					
Stage 3 – Monitoring the execution and ex-ante financial management	Cost of controls related to the monitoring of the execution / amount paid	269.500	3,6	338.900	3,6
Total ex-ante		392.800	5,1	491.400	5,2

JU's resources dedicated to ex-post controls in connection to grants:

Stage of the control	Description	Year			
		2021		2022	
		EUR	FTE	EUR	FTE
Stage 4 – Ex-post controls and recoveries	Total cost related to ex-post audits / grants audited	33.200	0,4	38.000	0,4
Total ex-post		33.200	0,4	38.000	0,4

JU's resources dedicated to ex-ante controls in connection to procurements:

Stage of the control	Description	Year			
		2021		2022	
		EUR	FTE	EUR	FTE
Stage 1 – Planning the procurement procedures, including legal checks		53.700	0,6	68.900	0,7
Stage 2 – Contracting, including financial (commitments, guarantees,...) and legal checks		48.900	0,6	61.200	0,7
Stage 3 – Monitoring the execution and Financial operations (ex-ante), controls on the acceptance of goods and services		66.600	0,8	80.300	0,9
Total ex-ante		169.200	2,0	210.400	2,3

JU's resources dedicated to ex-post controls in connection to procurements:

Stage of the control	Description	Year			
		2021		2022	
		EUR	FTE	EUR	FTE
Stage 4 – Supervisory checks (ex-post), audit, ex-post technical controls if relevant		8.300	0,1	9.100	0,1
Total ex-post		8.300	0,1	9.100	0,1

The internal JU's overall cost of controls (both ex-ante and ex-post) related to grants then represented approximately 0,4% of the EU-Rail operational expenditure/total expenditure in 2022.

The internal JU's overall cost of controls (both ex-ante and ex-post) related to procurements represented approximately 0,16% of the EU-Rail operational/total expenditure in 2022.

The ratios of combined internal cost related to both grants and procurements to the overall 2022 JU's costs are included in the following table:

JU expenditure in 2022 in EUR millions		Estimated overall costs of ex-ante controls in 2022 in EUR	Overall costs of ex-ante controls in relation to expenditures in %
Operational	135,6		
Total	139,8	701.800	0,52%
JU expenditure in 2022 in EUR millions		Estimated overall costs of ex-post controls in 2022 in EUR	Overall costs of ex-post controls in relation to expenditures in %
Operational	135,6		
Total	139,8	47.100	0,035%
			0,034%

In terms of own human resources allocated in 2022 to controls related to grants and procurements, both ex-ante and ex-post, approximately 7,9 FTEs were involved. This represents about 28,2% of the total FTEs employed by the JU as at year end 2022.

4.4. Cost-effectiveness of controls

The total estimated cost of controls (ex-ante + ex-post) related to grant management and procurement in 2022 represent approximately the amount of EUR 749.000. The increase in the amount compared to 2021 (EUR 603.500) is mainly attributable to the increase of activities following the entry into force of the EU-Rail Programme and launching of the new operational activities in 2022, with the consequence that the estimated FTEs dedicated to control activities increased slightly in 2022 compared to the previous year. This was possible with the revised Establishment Plan of EU-Rail following the new SBA.

Given the fact that many internal controls related to grants and procurements are standardised under the established workflows and procedures, and given the available personnel resources following from the EU-Rail staff establishment plan, it is expected that the number of FTEs dedicated to internal controls will probably not change dramatically in the future. Nevertheless, there might be qualitative changes in the deployment of controls, especially in the field of ex-post controls related to grants. With the application of lump sum form of grants, the focus of ex-post controls will no longer be on verifying the costs actually incurred by the beneficiaries, but rather on technical aspects of the grant implementation. In addition, slight shift of EU-Rail control capacities towards the procurement and contract management could be foreseen, as the amount of JU's funds deployed through procurements, and thus the inherent risk involved, will increase compared to the previous years.

With regard to cost-effectiveness of controls, the following table presents figures on overall cost spent at EU-Rail in 2022 on controls related to grants and procurements, compared to total cost⁷⁰:

Cost of controls / Total expenditure 2022 (administrative + operational)	0,54%
Cost of controls / Operational expenditure 2022	0,55%

The decrease in the ratio compared to 2021 (0,9%) is driven by the increase of the total JU's expenditure in 2022 compared to 2021, while the number of resources dedicated to ex-ante and ex-post controls remained roughly the same as last year.

As for the benefits and particular financial effects of the controls carried out, in most of the cases, these are not possible to be effectively calculated in a precise manner. In general, the main benefit of controls resides in the continuous reasonable assurance on the fact that the principle of sound financial management is being pursued which includes preventing and detecting potential irregularities. To a limited extent⁷¹, the recoveries following from the financial ex-post audits carried out by the CAS could be considered as a form of particular positive financial impact (benefit) resulting from controls. In this respect, Annex E, Table I of this CAAR provides the respective KPI on implementation of audit results.

In conclusion, from the JU's perspective, controls applied in grant management and procurement are considered cost-effective. Emphasis is given to adequate balance between low error rates and timely payments on one hand, and the costs dedicated to carrying out controls on the other hand. By deploying lump sum form of funding for the grants under its Programme, EU-Rail also strives for simplification for its beneficiaries by decreasing their administrative burden regarding reporting of costs during the lifetime of projects funded by the JU. In this connection, the fact that EU-Rail will need to a larger extent steer the ex-post control activities related to lump sum grants by means of its internal capacities and will not be able to count on the CAS in that respect, could increase the JU's cost of controls in the future, having potentially implications on the overall cost-effectiveness of controls. Anyway, achieving reasonable assurance with

⁷⁰ It should be noted that the quantification of JU's cost of controls is based to a certain extent on qualified estimates and simplified assumptions, as a more precise cost calculation would require continuous detailed time recording throughout the year of all particular control activities conducted at the level of all concerned staff members. Such recording would create excessive administrative burden and would not be considered feasible in terms of the cost-benefit ratio.

⁷¹ The primary aim of the control system should be on prevention, that is to minimise as such the occurrence of errors in grants and the necessity of subsequent recoveries.

regard to the sound financial management of the grant implementation will continue to be in focus of the Joint Undertaking.

4.5. Audit observations and recommendations

4.5.1. Internal Audit

In accordance with Article 28 of the JU Financial Rules, the internal audit function shall be performed by the Commission's Internal Audit Service (IAS). IAS reports on its findings and recommendations to the Joint Undertaking's GB and ED.

The internal auditor shall advise the JU on dealing with risks, by issuing independent opinions on the quality of management and control systems, and by issuing recommendations for improving the implementation of operations and promoting sound financial management.

In line with the International Standards for the Professional Practice of Internal Auditing IAS confirmed in March 2023 to the Chairperson of the EU-Rail GB and to the ED its organisational independence of their internal audit activity conducted in 2022, as well the fact that their work in 2022 was free from interference in determining the scope of internal auditing, performing work and communicating results. IAS also confirmed that in 2022, there was no impairment to individual objectivity, in particular through conflict of interest, scope limitations, restrictions on access to records, personnel, and properties, or resource limitations.

Following its risk assessment performed at the JU during 2020, IAS drew up their Strategic Internal Audit Plan for 2021-2023. In Q4 2022 the JU provided IAS with an update on the internal and external developments having influence on its business, as well as with its updated version of the risk register. EU-Rail was later notified by IAS that their engagement planned to be carried out in the JU in 2023 will take form of a new in-depth risk assessment.

Already in 2021, IAS launched their "Audit on H2020 grant implementation and closing". The objective of this audit was to assess the adequacy of the design and the efficiency and effectiveness of the internal controls in place in the JU for the implementation and closing of grant agreements under H2020.

The audit was finalized in September 2022 by issuing the final audit report. IAS concluded that the management and internal control system in EU-Rail with regard to the H2020 grant implementation and closing process is adequately designed and effectively and efficiently implemented. While the audit work did not result in the identification of any critical or very important issues, IAS identified room for further improvement in relation to:

- Formalization of the JU's risk-based monitoring approach at the projects/beneficiaries' level,
- Dissemination and exploitation aspects of the grant management,
- JU's anti-fraud policy and annual exercise for collecting declarations of interests from its staff,
- Implementation of workflows in the respective IT tools within the grant management process.

In response to the above-mentioned final audit report, EU-Rail provided to IAS the action plan for addressing the identified issues. These actions will be implemented and followed up in the course of 2023. At the time of drafting of this CAAR, EU-Rail considered having already covered the recommendation under the third bullet point here above (in this respect, see also Section 4.1.1.2.). However, formal follow-up procedure with IAS still needs to be carried out. The implementation of the other three recommendations will follow in the course of 2023.

4.5.2. Audit of the European Court of Auditors

The European Court of Auditors (ECA) with its mission of March 2022 completed its work which resulted in the JU's Annual Audit Report for the year 2021, in accordance with the ECA mandate as defined in the TFEU.

During 2022, for the 2021 Financial Year, the European Court of Auditors released the following opinions:

Opinion on the reliability of the accounts

“In our opinion, the accounts of the JU for the year ended 31 December 2021 present fairly, in all material respects, the financial position of the JU at 31 December 2021, the results of its operations, its cash flows, and the changes in net assets for the year then ended, in accordance with its Financial Regulation and with accounting rules adopted by the Commission’s accounting officer. These are based on internationally accepted accounting standards for the public sector.”

Opinion on the legality and regularity of revenue underlying the accounts

“In our opinion, revenue underlying the accounts for the year ended 31 December 2021 is legal and regular in all material respects.”

Opinion on the legality and regularity of payments underlying the accounts

“In our opinion, payments underlying the accounts for the year ended 31 December 2021 are legal and regular in all material respects.”

First, the ECA confirmed in its Annual report on EU Joint Undertakings for the financial year 2021, that all observations under follow-up for EU-Rail prior to 2021 have all been completed.

For the year 2021, the ECA reported no major or critical findings for the JU in its Annual report on EU Joint Undertakings for the financial year 2021. However, two observations were raised:

- *The JU implemented 100% of its 2021 commitment budget available for Horizon 2020 projects. The implementation rate for the JU’s 2021 operational payment budget available, including operational unused and reallocated appropriations, fell to 61% (2020: 76%). This situation was mainly caused by the poor quality of the beneficiaries’ technical reports and the need to request from the beneficiaries, additional evidence confirming the achievement of the project results. Most of the JU’s payments are lump-sums paid for project work packages that have been properly implemented by multiple beneficiaries. Consequently, the delay of a single beneficiary affects the payment of the whole lump-sum amount related to the work package.*
- *The second one is applicable for all the Joint Undertakings and mentions that in line with the Commission’s guidance to the JUs, the Commission’s Office for Administration and Payment of Individual Entitlements should calculate the employer contribution for each JU as a percentage of the non-EU revenue related to the total revenue of the JU, including non-EU revenue for operational expenditure. For EU-Rail this percentage share is 3,8% or around EUR 10.445 per year (based on 2021 figures). This guidance only takes account of the respective provisions of the Staff Regulations in determining the calculation method for the JUs’ payments of employer contributions to the EU budget based on revenue. However, the Single Basic Act specifies that administrative costs should be covered equally, on an annual basis between the EU and the other members, suggesting an employer contribution of around EUR 137.435 per year for the JU (based on 2021 figures). The concurrence of these different legal provisions risks the elaboration of diverse interpretations regarding the calculation of the JU’s employer contribution, with varying financial impact.*

On the first observation, the JU replies that in 2021, EU-Rail successfully made more than 70 payments related to operational tenders and grant agreements for a total amount of EUR 39,3 million. The JU highlighted to the Governing Board the importance of the quality of the beneficiaries’ reporting and the need for beneficiaries and/or contractors to comply with deadlines. It informed the GB in November 2021 that, due to the beneficiaries’ delays in the submission of payment requests and underlying documents, payment appropriations of around EUR 17,5 million would remain unused at the year-end. Finally, the JU had to transfer this amount to the unused appropriations in order to be re-inscribed into the payment appropriations for 2022. It is the JU’s view that with this reallocation it achieved an implementation rate for operational payments (Title 3) of 84%.

On the second observation, EU-Rail confirmed together with the other Joint Undertakings that it agrees to pay its employer’s pension contributions in line with the calculation to be provided by the Commission’s services, once de-jure aspects are ascertained, and invoices are issued by the PMO. Although the JU has no mandate to accept that a contradiction exists between the estimation approach provided by

Commission's services and the referenced provisions of the Single Basic Act, EU-Rail is open and willing to resolve the matter in cooperation with the Commission's services. Furthermore, Article 28 of the SBA defines that the operational costs of a JU should be covered by means of the financial contributions by the EU and private members. In the view of the JU, this contradicts article 83(2) of the Staff regulations that bases the calculation of the EU bodies' (agencies') employer contribution to the EU pension scheme on revenues. Finally, it is to be noted that following the invoicing of employer contribution made by PMO to the JU, EU-Rail paid its share in 2023, and will continue doing so in future.

In addition, following the draft preliminary ECA observations on fiscal year 2022, three findings were raised and still under discussion, regarding:

- The ECA considers that the selection committee members of one recruitment procedure did not assess the two evaluation criteria on professional experience as required by the exclusively quantitative terms of the vacancy notice (and scoring guide).
- In 2022, the KDT JU concluded a service level agreement (SLA) with EU-Rail. By means of this SLA, the KDT JU granted power of attorney to the EU-Rail JU to sign a specific contract on its behalf, under the framework contract. The framework contract was exclusively procured and signed by the EU-Rail JU.
- In its 2022 provisional annual accounts, the JU has not disclosed important information relevant for the correct and complete communication of the JUs' financial and budgetary position at year end. Nor has the JU disclosed its achievements regarding the legal contribution targets set for the programmes under which it operates.

Considering that EU-Rail has sent its formal replies before the finalisation of this 2022 CAAR, the discussion on the topics should be considered still ongoing and the results subject to further confirmation. However, it is important to mention that EU-Rail has provided to the ECA all the necessary legal basis confirming that the JU runs its recruitment procedures and procurement procedures in full respect of existing legal framework.

Finally, for the last finding, the JU has understood that the Court's comments on the above topics represent recommendations for improvement as they are related either to the visual presentation of the JUs' financial information or the inclusion of additional financial information unrelated to the financial statements of the entities. As such it is important to underline and recognise that the proposed improvements do not impact the financial and budgetary position of the entities at the end of the year.

4.5.3. Overall Conclusions

In 2022, no critical findings/observations were issued for EU-Rail neither by IAS, nor by ECA, which would indicate any serious issues or deficiencies with regard to the JU's risk management or to the design and implementation of its internal control system.

4.6. Assessment of the effectiveness of internal control systems

4.6.1. Continuous monitoring

In 2019, the JU started the process of implementing its new Internal Control Framework (ICF) based on the EC Internal Control Standards, also with the objective of introducing a more pro-active approach in the design and implementation of internal controls, rather than focusing mostly on the compliance aspects. This process resulted in 2020 in the adoption of a revised ICF by means of the Executive Director's Decision ED-20-08.

The JU's ICF is designed to provide reasonable assurance regarding the achievement of the following objectives:

- Effectiveness, efficiency and economy of operations;
- Reliability of reporting;
- Safeguarding of assets and information;
- Prevention, detection, correction and follow-up of fraud and irregularities;

- Adequate management of the risks relating to the legality and regularity of the underlying transactions, taking into account the multiannual character of the JU Programme as well as the nature of the payments concerned.

Ever since the revised ICF was adopted, it has been implemented by the Executive Director in the organisation's day-to-day activities, with the support of the Internal Control Coordinator, involving all staff across all JU functions as well. This process included also further fine-tuning of the internal controls and maintaining awareness among the staff of the ICF and its importance for achieving the JU's objectives.

The design of internal controls and their effective implementation is subject to continuous considerations and the ICF is amended, as deemed necessary. Such continuous monitoring is supplemented by annual in-depth self-assessment exercises aimed at comprehensive evaluation of the presence and functioning of all 17 internal control Principles, forming the five Components of the EU-Rail internal control system⁷²:

1. Control environment
2. Risk assessment
3. Control activities
4. Information and communication
5. Monitoring activities

The latest annual ICF self-assessment evaluating the situation in 2022 was conducted in Q1 2023. The assessment was carried out on the basis of 53 indicators and taking into account all relevant information available at that time, including the results from previous internal/external audits and the records in the JU's register of exceptions and non-compliance events.

After due assessment, no major or critical deficiencies in internal controls were identified. All individual ICF Principles as well as Components were found to be present and functioning, however some improvements are needed for the Component no. 3 where minor shortcomings were identified. Thus, on this basis, it can be concluded that the JU's control system as a whole is present and functioning well.

4.6.2. Risk assessment and management

EU-Rail's risk assessment and risk management activities follow the principles of the recognised international standards and are aligned to the requirements of the Commission as indicated in its Communication SEC(2005)1327 "*Towards an effective and coherent risk management in the Commission services*"⁷³. It is a continuous process involving clear communication to governance bodies, staff, and stakeholders on how EU-Rail positions itself in the management of risks and opportunities that can affect the achievement of its objectives, taking into consideration the assessment of the level of uncertainty that the JU is willing to accept (risk appetite). The Executive Director approves the policy and sets the tone, staff at the different levels implement the policy in the day-to-day operations. The Governing Board takes account of the most relevant risks and of the related action plan depicted in the JU's risk register, brought to its attention by means of the Consolidated Annual Activity Report and the Work Programmes.

Risk is defined as "*any event that could occur and adversely impact the achievement of the Joint Undertaking's strategic and operational objectives. Lost opportunities are also considered a risk*".

The Risk Management system aims at enabling informed decision making with the objective of optimising the ratio between the level of risk acceptable to the JU on one hand, and, on the other hand, the use of the relevant resources related to identifying, analysing, treating, and monitoring of risks and opportunities.

In the months of October and November 2022, in accordance with the JU's Policy for Risk Management as defined in its Governance and Process Handbook, the JU performed a risk assessment exercise with the aim of updating the elements related to risks and opportunities already included in its risk register, as well as identifying potential new ones. Within this exercise, due account was taken of topical internal and external factors and developments having influence on JU's business. Attention was given also to the fraud risks, where a separate dedicated risk assessment was carried out in connection with the adoption of the JU's new Anti-Fraud Strategy. The updated EU-Rail risk register was shared with IAS for the purposes of

⁷² The EU-Rail ICF is based on the COSO Internal Control Integrated Framework, also applied by the Commission services.

⁷³ https://commission.europa.eu/publications/risk-management_en

their 2023 audit plan preparation. The JU also consulted its risks with its parent Commission service – DG MOVE, as well as EU-Rail actively participated within the respective cluster of JUs and Agencies in the peer review of the most important risks for 2023 steered by EUAN Performance Development Network.

The risks identified in the above-mentioned risk assessment activities which require, due to their criticality, continuous attention and treatment of the Executive Director and, where relevant, of the Governing Board, are presented in the JU Work Programme 2023-2024 and the follow-up outcomes on these risks will be presented in the 2023 CAAR. Follow-up considerations applicable to the most relevant risks identified for 2022 are presented in Section 1.1 of this CAAR.

In March 2023, IAS confirmed to EU-Rail that their engagement planned to be carried out in the JU in 2023 will take form of a new in-depth risk assessment. EU-Rail will grant to IAS full cooperation in exercising this assessment and will take advantage of its results so that duplication of efforts with similar internal JU activities are avoided.

EU-Rail also intends in 2023 to better formalize within the grant management its risk-based monitoring approach at the level of individual projects and beneficiaries in line with the respective IAS recommendation following from their “Audit on Horizon 2020 grant implementation and closing”.

4.6.3. Prevention of Conflict of Interest

As for the treatment of potential conflicts of interests, and to implement the requirements following from its constituent act with regard to this matter, the JU has adopted the respective rules by means of its internal legal framework applicable to its managers, staff, as well as the members of its Governing Board. The annual declarations of interests of the latter are publicly available in the JU official website.

Thus, as it was the case in the past, EU-Rail will continue also in the future to apply various measures, such as:

- requiring annual declarations of interests from the staff members;
- utilization of independent experts who will be obliged to declare any potentially conflicting interests;
- assessing potential conflicts of interests of persons (including those coming from outside of EU-Rail) involved in recruitment procedures, calls for proposals/tenders evaluations, etc.;
- requiring annual declaration of interests from the Governing Board members, as well as declaration of confidentiality and conflict of interest from all attendees to each EU-Rail's Governing Board meeting.

Furthermore, the JU Executive Director will continue in the practice of stressing to the staff and to the GB members the importance of compliance to the highest standards in ethical matters, including the situations potentially involving conflicts of interests. The JU's Internal Control Coordinator and HR Officer will support the ED in this respect, especially by engaging in awareness-raising activities addressing the EU-Rail staff.

4.7. Conclusion on the assurance

The EU-Rail Executive Director ad interim is not aware of any element that would bring him to introduce a reservation in this 2022 CAAR.

In addition to the specific supervisory activities carried out by the ED himself, the main elements supporting further the reasonable assurance related to the principle of sound financial management are:

- the Certificate of the Accounting Officer;
- the information received from the Head of Programme, the Head of Corporate Services, Head of the System Pillar Unit, the Chief Stakeholder Relations and Dissemination, and from the Chief Legal Officer/Data Protection Officer;
- the assessment of the Internal Control Framework carried out by the JU's Internal Control Coordinator;
- the results of the audit of the ECA;
- audits performed by the Internal Audit Service of the Commission;
- the overall risk management performed in 2022 and supervised by the ED;

- the assessment of the key performance indicators;
- the dedicated ex-ante controls of the JU's operational and administrative expenditure;
- the results from ex-post audits carried out by the Common Audit Service of DG RTD;
- the JU Members' reporting of their in-kind contributions/total project costs, as applicable;
- the monitoring and follow-up of the processes related to the calls for proposals/tenders;
- the deployment of independent external experts and observers in grant management;
- information reported in the JU's register of exceptions and non-compliance events and the related remedial measures put in place.

4.8. Statement of Assurance

4.8.1. Assessment of the Consolidated Annual Activity Report by the Governing Board

The ED submits the draft CAAR to the Joint Undertaking's Governing Board for assessment and approval. Once approved by the GB, the CAAR is made publicly available. No later than 1 July of each year the CAAR together with its assessment shall be sent by the Executive Director to the European Court of Auditors, to the Commission, to the European Parliament and to the Council.

The EU-Rail GB takes note of the results achieved and recommends the JU to continue improving its effectiveness and efficiency with the Members' stronger support.

4.8.2. Declaration of assurance

I, the undersigned, Giorgio Travaini, Executive Director ad interim of the Europe's Rail Joint Undertaking

In my capacity as authorising officer by delegation

Declare that the information contained in this report gives a true and fair view⁷⁴.

State that I have reasonable assurance that the resources assigned to the activities described in this report have been used for their intended purpose and in accordance with the principles of sound financial management, and that the control procedures put in place give the necessary guarantees concerning the legality and regularity of the underlying transactions.

This reasonable assurance is based on my own judgement and on the information at my disposal, such as the results of the self-assessment, ex-post controls, the work of the Internal Control Coordinator, the observations of the Internal Audit Service and the lessons learnt from the reports of the Court of Auditors for years prior to the year of this declaration.

Confirm that I am not aware of anything not reported here which could harm the interests of the Joint Undertaking.

Brussels, 23 June 2023

Giorgio Travaini
Executive Director ad interim

⁷⁴ True and fair in this context means a reliable, complete, and correct view on the state of affairs in the Joint Undertaking.



5. ANNEXES



ANNEX A: Organisational structure of EU-Rail

New organisational structure adopted on 01/03/2022



ANNEX B: Establishment plan and additional information on HR management

Function group and grade	YEAR 2021				YEAR 2022			
	Authorised		Actually filled as of 31/12		Authorised		Actually filled as of 31/12	
	Perm. posts	Temp. posts	Perm. posts	Temp. posts	Perm. posts	Temp. posts	Perm. posts	Temp. posts
AD 16								
AD 15		1				1		
AD 14				1				1
AD 13								
AD 12								
AD 11								
AD 10		2		2		2		2
AD 9		1				1		1
AD 8		1		1		1		1
AD 7				1				
AD 6		4				4		4
AD 5		1				1		1
TOTAL AD	10		5		10		10	
AST 11								
AST10								
AST 9								
AST 8								
AST 7								
AST 6								
AST 5								
AST 4								
AST 3								
AST 2								
AST 1								
TOTAL AST								
AST/SC 6								
AST/SC 5								
AST/SC 4								
AST/SC 3								
AST/SC 2								
AST/SC 1								
TOTAL AST/SC								
GRAND TOTAL	10		5		10		10	

Contract Agents	Authorized	Actually filled as of 31/12/2022
Function Group IV	13	13
Function Group III	3	3
Function Group II	1	1
Function Group I		
TOTAL	17	17

Seconded National Experts	Authorized	Actually filled as of 31/12/2022
	2	1
TOTAL	2	1

The full staffing as per the JU's Staff Establishment Plan comprises 29 posts. One SNE position was not yet filled as at yearend 2022. In addition, until the new Executive Director is appointed, as of 1 March 2023, the Head of Programme executes the function of the ED ad interim.

ANNEX C: Publications and external events participated to by the joint undertaking in 2022

Overview of publications and events

JU 2022 PUBLICATIONS

Title	Publication Date	Link to publication
Catalogue of Solutions, 2022 Edition	20 September 2022	https://rail-research.europa.eu/wp-content/uploads/2022/09/Europes-Rail-Catalogue-of-Solutions-v4.pdf
Europe's Rail Factsheet	16 September 2022	https://rail-research.europa.eu/wp-content/uploads/2022/09/Europes-Rail-Factsheet-v5.pdf
Annual Activity Report 2021: Executive View	16 September 2022	https://rail-research.europa.eu/wp-content/uploads/2022/09/Europes-Rail-Annual-Activity-Report-v7.pdf

JU 2022 PRESS RELEASES

Title	Publication Date	Link to publication
Europe's Rail officially launched during the European Railway Summit in the context of the French Presidency of the European Union	21 February 2022	https://rail-research.europa.eu/press-releases/europes-rail-officially-launched-during-the-european-railway-summit-in-the-context-of-the-french-presidency-of-the-european-union/
Europe's Rail publishes its Call for Proposals 2022-1	10 March 2022	https://rail-research.europa.eu/press-releases/europes-rail-publishes-its-call-for-proposals-2022-1/
Memorandum of Understanding on the study 'Smart and Affordable High-Speed Services in the European Union' signed on 29 June 2022	29 June 2022	https://rail-research.europa.eu/press-releases/memorandum-of-understanding-on-the-study-smart-and-affordable-high-speed-services-in-the-european-union-signed-on-29-june-2022/
Europe's Rail Joint Undertaking System Pillar Tender Awarded	13 July 2022	https://rail-research.europa.eu/press-releases/europes-rail-joint-undertaking-system-pillar-tender-awarded/
Europe's Rail awards six grants for its very first Call for Proposals 2022-1	9 September 2022	https://rail-research.europa.eu/press-releases/europes-rail-awards-six-grants-for-its-very-first-call-for-proposals-2022-1/
Europe's Rail brings innovative rail solutions to InnoTrans 2022	13 September 2022	https://rail-research.europa.eu/press-releases/europes-rail-brings-innovative-rail-solutions-to-innotrans-2022/

Europe's Rail announces its Call for Proposals 2022-2 at InnoTrans	20 September 2022	https://rail-research.europa.eu/press-releases/europes-rail-announces-its-call-for-proposals-2022-2-at-innotrans/
--	-------------------	---

JU 2022 NEWSLETTERS

Title	Publication Date	Link to Publication
Join us for the launch ceremony of Europe's Rail Joint Undertaking: January 2022 Newsletter	28 January 2022	https://mailchi.mp/rail-research.europa.eu/january2022newsletter
Europe's Rail officially launched during the European Railway Summit: February 2022 Newsletter	24 February 2022	https://mailchi.mp/rail-research.europa.eu/february2022newsletter
Europe's Rail publishes its Call for Proposals 2022-1: March 2022 Newsletter	29 March 2022	https://mailchi.mp/rail-research.europa.eu/march2022newsletter
Register now for Europe's Rail 2022 Info Day on System Pillar: April 2022 Newsletter	29 April 2022	https://mailchi.mp/rail-research.europa.eu/april2022newsletter
Visit Europe's Rail at the World Congress on Rail Research: May Newsletter	30 May 2022	https://mailchi.mp/rail-research.europa.eu/may2022newsletter
Europe's Rail Memorandum of Understanding on a high-speed study: June 2022 Newsletter	30 June 2022	https://mailchi.mp/rail-research.europa.eu/june2022newsletter
Europe's Rail brings innovative rail solutions to InnoTrans 2022: September 2022 Newsletter	16 September 2022	https://mailchi.mp/rail-research.europa.eu/september2022newsletter
Visit Europe's Rail at TRA 2022: October 2022 Newsletter	27 October 2022	https://mailchi.mp/rail-research.europa.eu/october2022newsletter
Join Europe's Rail Innovation Days on 7-9 December: November 2022 Newsletter	29 November 2022	https://mailchi.mp/rail-research.europa.eu/november2022newsletter
Europe's Rail First Flagship Projects: December 2022 Newsletter	21 December 2022	https://mailchi.mp/rail-research.europa.eu/december2022newsletter

PRESS ARTICLES ABOUT THE JU PUBLISHED IN 2022

Press outlet	Title	Link to the Publication
1. International Railway Journal	AŽD Praha demonstrates first autonomous train in Czech Republic	1. https://www.railjournal.com/signalling/azd-praha-demonstrates-first-autonomous-train-in-czech-republic/
	France sets out transport priorities for EU Presidency	2. https://www.railjournal.com/policy/france-sets-out-transport-priorities-for-eu-presidency/
	Network Rail's vision for the post-pandemic railway	3. https://www.railjournal.com/in_depth/network-rails-vision-for-the-post-pandemic-railway
	Europe's Rail launched in ceremony in Paris	4. Europe's Rail launched in ceremony in Paris - International Railway Journal (railjournal.com)
	Is the single European Rail Area achievable or an impossible dream	5. Is the Single European Rail Area achievable or an impossible dream? - International Railway Journal (railjournal.com)
	Europe's Rail issues first call for proposals	6. Europe's Rail issues first call for proposals - International Railway Journal (railjournal.com)
	Research still valuable for rail freight	7. Research still valuable for rail freight - International Railway Journal (railjournal.com)
	Time to turn words into deeds	8. Time to turn words into deeds - International Railway Journal (railjournal.com)
	Mainline ATO a huge opportunity if railways can get it right	9. Mainline ATO a huge opportunity if railways can get it right - International Railway Journal (railjournal.com)
	Out with the old, in with the new	10. Out with the old, in with the new - International Railway Journal (railjournal.com)
	Europe's Rail System Pillar implementation plan confirmed	11. Europe's Rail System Pillar implementation plan confirmed
	Railway researchers urged to make an impact	12. Railway researchers urged to make an impact
	Cross-industry collaboration can deliver improved performance	13. Cross-industry collaboration can deliver improved performance
	European partners to study smart and affordable high-speed rail	14. European partners to study smart and affordable high-speed rail
	Rethinking the European railway	15. Rethinking the European railway
	Europe's Rail launches second call for proposals	16. Europe's Rail launches second call for proposals
	IRJ InnoTrans 2022 preview; A-E	17. IRJ InnoTrans 2022 preview; A-E
	Germany funds project to develop driverless regional trains using AI	18. Germany funds project to develop driverless regional trains using AI
	Young leaders in rail awards 2022	19. Young leaders in rail awards 2022
	DAC technology ready but challenges remain for European rollout	20. DAC technology ready but challenges remain for European rollout
	InnoTrans 2022 review; Part 2	21. InnoTrans 2022 review; Part 2
2. Global Railway Review	Interview: 'We have the tools – it is in our hands to deliver'	22. https://www.railwaygazette.com/in-depth/interview-we-have-the-tools-it-is-in-our-hands-to-deliver/60687.article
	Article: Silverstar Project: Soil vibration and auralisation software tools for application in railways.	23. SILVARSTAR project: Soil vibration and auralisation software tools for application in railways (globalrailwayreview.com)
	Europe's Rail Joint Undertaking officially launched	24. Europe's Rail Joint Undertaking officially launched (globalrailwayreview.com)

	Europe's Rail Joint Undertaking publishes Call for Proposals 2022-1	25. Europe's Rail Joint Undertaking publishes Call for Proposals 2022-1 (globalrailwayreview.com)
	DAC: Ensuring rail freight can play the role it deserves in Europe	26. DAC: Ensuring rail freight can play the role it deserves in Europe (globalrailwayreview.com)
	MoU on Affordable High-Speed Services in the European Union signed	27. MoU on Affordable High-Speed Services in the European Union signed
	Six grants awarded under EU-Rail's first Call for Proposals 2022-1	28. Six grants awarded under EU-Rail's first Call for Proposals 2022-1
	What is needed to accelerate the overall deployment of ERTMS?	29. What is needed to accelerate the overall deployment of ERTMS?
	Europe's Rail to showcase innovative rail solutions at InnoTrans 2022	30. Europe's Rail to showcase innovative rail solutions at InnoTrans 2022
	Global Railway Review Article: Looking ahead to InnoTrans 2022	31. Global Railway Review Article: Looking ahead to InnoTrans 2022
	The EU's plans for attractive, efficient, and competitive rail	32. The EU's plans for attractive, efficient, and competitive rail
	Global Railway Review Roundtable: Passenger Experience	33. Global Railway Review Roundtable: Passenger Experience
	The role of alternative fuels in the decarbonisation of Europe's rail sector	34. The role of alternative fuels in the decarbonisation of Europe's rail sector (globalrailwayreview.com)
	UNIFE explore ERTMS at InnoTrans 2022	35. UNIFE explore ERTMS at InnoTrans 2022
	Europe's Rail announce Call for Proposals 2022-2 at InnoTrans	36. Europe's Rail announce Call for Proposals 2022-2 at InnoTrans
	CER present DAC Sector Statement at InnoTrans 2022	37. CER present DAC Sector Statement at InnoTrans 2022
	Global Railway Review at InnoTrans – Day three recap	38. Global Railway Review at InnoTrans – Day three recap
	AI project to facilitate the advancement of driverless regional trains launched	39. AI project to facilitate the advancement of driverless regional trains launched
	The case for a federated digital model of the rail system	40. The case for a federated digital model of the rail system
	Towards 'Roadmaps for AI Integration in the Rail Sector'	41. Towards 'Roadmaps for AI Integration in the Rail Sector'
	How to take forward ERTMS for a modern Italian railway system	42. How to take forward ERTMS for a modern Italian railway system
3. Railway Gazette	Europe's Rail research initiative launched	43. Europe's Rail research initiative launched News Railway Gazette International
	Research: Shifting to Europe's Rail	44. Research: Shifting to Europe's Rail In depth Railway Gazette International
	Europe's Rail research programme issues first call for proposals	45. Europe's Rail research programme issues first call for proposals News Railway Gazette International
	Carbon fibre reinforced polymer high speed train running gear frame on test	46. Carbon fibre reinforced polymer high speed train running gear frame on test News Railway Gazette International
	Hyperloop hype at InnoTrans	47. Hyperloop hype at InnoTrans

	'Get into the Flow' with Knorr-Bremse	48. 'Get into the Flow' with Knorr-Bremse
	Signalling: OCORA aims at onboard simplification	49. Signalling: OCORA aims at onboard simplification
	Competitive Freight Wagon aims to boost rail freight	50. Competitive Freight Wagon aims to boost rail freight
	Europe: Overcoming the language barrier	51. Europe: Overcoming the language barrier
	Call for flexibility on train driver language requirements	52. Call for flexibility on train driver language requirements
	Interview: Rail can address Europe's societal challenges	53. Interview: Rail can address Europe's societal challenges
4. RailTech.com	Europe's Rail Joint Undertaking launches officially	54. Europe's Rail Joint Undertaking launches officially (railway-technology.com)
	Europe's Rail issues this year's first call for proposals to advance railway technology	55. Europe's Rail issues this year's first call for proposals to advance railway technology RailTech.com
	Join the discussion about infrastructure monitoring and maintenance at the Intelligent Rail Summit	56. Join the discussion about infrastructure monitoring and maintenance at the Intelligent Rail Summit
5. Horizon Magazine	How future trains could be less noisy	57. https://ec.europa.eu/research-and-innovation/en/horizon-magazine/how-future-trains-could-be-less-noisy
6. ERTMS Newsletter	In the spotlight: Interview with Mr. Borghini, Executive Director of Europe's Rail Joint Undertaking	58. https://transport.ec.europa.eu/transport-modes/rail/ertms/ertms-newsletter_en
7. Rieles Multimedia	COMSA Corporation participates in 4 European railway innovation projects	59. COMSA Corporation participates in 4 European railway innovation projects
8. MAGYAR ÉPÍTŐK	Research and innovation help to double the capacity of the European railway system (in Hungarian)	60. Research and innovation help to double the capacity of the European railway system
9. Navarra Capital	The technological center of the University of Navarra will invest 40 million in four years	61. The technological center of the University of Navarra will invest 40 million in four years
10. EL ESPAÑOL	Laura Saralegui: "Indra's innovation is a mission shared by all its professionals" (in Spanish)	62. Laura Saralegui: "Indra's innovation is a mission shared by all its professionals"
11. B2B magazine	InnoTrans 2022 Report	63. InnoTrans 2022 Report
12. CleanTechnica	Wabtec's 100% Electric Locomotive Trickle Suddenly Becomes International Flood	64. https://cleantechnica.com/2022/01/17/wabtecs-100-electric-locomotive-trickle-suddenly-becomes-international-flood/
13. RailTarget	Live: Seminar on Digital Automatic Coupling (DAC) in Bratislava Has Started	65. Live: Seminar on Digital Automatic Coupling (DAC) in Bratislava Has Started
14. Urban Transport News	Siemens begins digitalization and automation for driverless regional trains	66. Siemens begins digitalization and automation for driverless regional trains
15. MarketScreener	Indra Sistemas SA: reinforces its position as one of the most innovative European companies in its sector by MarketScreener	67. https://m.marketscreener.com/quote/stock/INDRA-SISTEMAS-S-A-413470/news/Indra-Sistemas-S-A-reinforces-its-position-as-one-

		of-the-most-innovative-European-companies-in-its-37516243/
16.SpoorPro	ProRail and NS become core members of EU research program EU-Rail (in Dutch)	68. https://www.spoorpro.nl/management/2021/12/24/prorail-en-ns-worden-kernlid-van-eu-onderzoeksprogramma-eu-rail/
	TÜV Rheinland Develops Certification Roadmap for Hyperloop Development (in Dutch)	69. https://www.spoorpro.nl/innovatie/2021/12/31/tuv-rheinland-ontwikkelt-certification-roadmap-voor-hyperloop-ontwikkeling/
17.Bundesministerium für Digitales und Verkehr	Digital revolution in freight transport: test train starts to travel through Europe (in German)	70. https://www.bmvi.de/SharedDocs/DE/Pressemitteilungen/2022/005-digitale-revolution-im-gueterverkehr.html
18.Diario de Sevilla	The CE industrial ranking recognizes Indra's effort in innovation (in Spanish)	71. https://www.diariodesevilla.es/empresas-al-dia/industrial-CE-reconoce-Indra-innovacion_0_1646536742.html
19.Wirtualny Nowy Przemysł	Railway without borders. Closer to the elimination of a serious barrier (in Polish)	72. https://www.wnp.pl/logistyka/kolej-bez-granic-coraz-blizej-likwidacji-powaznej-bariery.524039.html
20.AB4Rail	The mid term dissemination event has been scheduled within the AB4Rail project	73. "The Mid-term dissemination event has been scheduled within the AB4Rail project! - AB4RAIL Project
21.Railway Pro	Europe's Rail Joint Undertaking begins its innovation journey	74. Europe's Rail Joint Undertaking begins its innovation journey (railwaypro.com)
	Rail can become the future of transport	75. Fit-for-55 can be the rail momentum (railwaypro.com)
22.BtoB Rail	Europe's Rail officially launched during the European Railway Summit in the context of the French Presidency of the European Union	76. BtoB Rail - Press release - Europe's Rail officially launched during the European Railway Summit in the context of the French Presidency of the European Union
	Europe's Rail Joint Undertaking brings innovative rail solutions to InnoTrans 2022	77. Europe's Rail Joint Undertaking brings innovative rail solutions to InnoTrans 2022
	Shifting to Europe's Rail	78. BtoB Rail - Shifting to Europe's Rail
23.European Commission	Commission and EU Agencies agree on a joint action plan with Cyprus to improve migration management	79. Daily News 21 / 02 / 2022 (europa.eu)
	End of the European Year of Rail – beginning of a new journey	80. End of the European Year of Rail – beginning of a new journey (europa.eu)
24. Seeking Alpha	Westinghouse Air Brake Technologies Corporation	81. Westinghouse Air Brake Technologies Corporation (WAB) CEO Rafael Santana on Q4 2021 Results - Earnings Call Transcript Seeking Alpha
25.Energia Oltre	Transporti, Arriva Europe's Rail Joint Undertaking, nuovo partenariato UE per ricerca e innovazione nel ferroviario (in Italian)	82. Trasporti, arriva Europe's Rail Joint Undertaking, nuovo partenariato UE per ricerca e innovazione nel ferroviario - Energia Oltre

26. Metaforespress	Shift2Rail ends and Europe's Rail is coming. What is it and what is its purpose (in Greek)	83. Τέλος το Shift2Rail, έρχεται το Europe's Rail. Τι είναι και ποιος ο στόχος του - Metaforespress
27. La Repubblica	Trains the European railway pact for Environmental sustainability signed by 33 operators and 24 countries (in Italian)	84. Treni, sottoscritto da 33 operatori e 24 Paesi il Patto ferroviario europeo per la sostenibilità – ambientale - la Repubblica
28. Affaritaliani	FS Italiane, sings membership of Europe's Rail (in Italian)	85. FS Italiane, Ferraris firma l'adesione all'Europe's Rail - Affaritaliani.it
29. Ferrovie dello Stato Italiane	Innovation and sustainability in the future of rail transport (in Italian)	86. Innovazione e sostenibilità nel futuro del trasporto ferroviario (fsitaliane.it)
30. TuttoTreno	Blog: FS Italiane among the 33 signatory companies of the European Railway Pact (in Italian)	87. FS Italiane tra le 33 aziende firmatarie del Patto Ferroviario Europeo (tuttotreno.it)
31. Nakolei	PKP S.A. co-creates the European R&D action plan for railways (in Polish)	88. PKP S.A. współtworzą europejski plan działań badawczo-rozwojowych dla kolei - Portal Kolejowy NaKolei.pl
32. Via Libre	Official presentation of Europe's Rail (in Spanish)	89. Presentación oficial de Europe's Rail (vialibre-ffe.com)
	Spanish participation in Europe's Rail	90. Spanish participation in Europe's Rail (spanishrailwaysnews.com)
	The Spanish Railway Technology Platform analyses the new innovation opportunities (in Spanish)	91. La Plataforma Tecnológica Ferroviaria Española analiza las nuevas oportunidades de innovación (vialibre-ffe.com)
	Euskotren reduces energy consumption in its commuter trains by 7 percent (in Spanish)	92. Euskotren reduces energy consumption in its commuter trains by 7 percent
33. European Energy Innovation magazine	How rail is key to decarbonise transport and contributes to the EU's green recovery	93. European Energy Innovation magazine - spring 2022 edition
34. Flickread	Research still valuable for rail freight	94. March 2022 (flickread.com)
35. Fincons Group	How prototyping will innovate the rail environment	95. How prototyping will innovate the rail environment (finconsgroup.com)
36. Wabtec Corporation	Breaking a technology lock to make rail transport systems more efficient	96. Breaking a technology lock to make rail transport systems more efficient Wabtec Corporation
37. Luc Levert Rail Passion	The digital freight wagon wins ground in Europe (in French)	97. ARTICLE-LUC-LEVERT-LE-WAGON-DE-FRET-DIGITAL-RAIL-PASSION-MARS-2022.pdf (shift2rail.org)
38. Technische Universität Dresden	Europe's Rail Call for Proposals 2022-1 is open for submissions	98. Europe's Rail Call for Proposals 2022-1 is open for submissions! — Faculty of

		Mechanical Science and Engineering — TU Dresden (tu-dresden.de)
39.Eltis	European Commission announces winners of woman in Rail Award	99. European Commission announces winners of Women in Rail Award Eltis
40.GATX Rail Europe	Steps to introduce DAC in Europe	100. Steps to Introduce DAC in Europe - gatx.eu - EN
41.Nature Portfolio	Technical feasibility analysis and introduction strategy of the virtually coupled train set concept	101. Technical feasibility analysis and introduction strategy of the virtually coupled train set concept Scientific Reports (nature.com)
42.BusinessGreen	How technology is making travel more sustainable	102. How technology is making travel more sustainable BusinessGreen Opinion
43.IoT For All	How the Railroad Industry is Leveraging IoT Edge Computing	103. How the Railroad Industry is Leveraging IoT Edge Computing (iotforall.com)
44.Lexology	Sustainability series: Part 2 – Rail Freight Transport	104. Sustainability series: Part 2 - Rail freight transport - Lexology
45.Trasporti Italia –	Europe's Rail: the first call for proposals of the European program for railways has been published (in Italian)	105. Europe's Rail: pubblicato il primo bando del programma europeo per le ferrovie - Trasporti-Italia.com
	European Railway Joint Undertaking: off to the first projects for over 568 million euros	106. European Railway Joint Undertaking: off to the first projects for over 568 million euros
46.Expreso, diario de viajes y turismo	Europe's Rail officially launched (in Spanish)	107. Lanzada oficialmente Europe's Rail Expreso
47.Expok	Drive sustainable travel technology (in Spanish)	108. Impulsa tecnología viajes sostenibles (expoknews.com)
48.ABC.es	The railway becomes the locomotive of sustainable mobility (in Spanish)	109. El ferrocarril se convierte en la locomotora de la movilidad sostenible (abc.es)
49.Interempresas	The president of Adif claims the key role of the railway to achieve the SDGs and as the axis of the new mobility (in Spanish)	110. La presidenta de Adif reivindica el papel clave del ferrocarril para lograr los ODS y como eje de la nueva movilidad - Ferrocarril (interempresas.net)
50.Koran Jakarta	Electric Locomotive for Mining Sector (in Indonesian)	111. https://koran-jakarta.com/lokomotif-listrik-untuk-sektor-pertambangan
51.Railway News	Talgo and Indra Partner to Become Founding Member of Europe's Rail Programme	112. Talgo and Indra Partner to Become Founding Member of Europe's Rail Programme Railway-News
	Talgo Unveils new Lightweight running Gear Frame	113. Talgo Unveils New Lightweight Running Gear Frame Railway-News

	European DAC Day Conference Brings Migration a Step Closer	114. European DAC Day Conference Brings Migration a Step Closer
52.UIC	First meeting of the new European Management Committee College held on 1 April 2022	115. First meeting of the new European Management Committee College held on 1 April 2022 UIC Communications
53.EPICOS	Europe's Rail System Pillar	116. Europe's Rail System Pillar EPICOS
54.Talgo	Indra and Talgo join forces in Europe's Rail, the largest rail innovation program in Europe, which drives the digitalization and sustainability of the sector – corporate	117. Indra and Talgo join forces in Europe's Rail, the largest rail innovation program in europe, which drives the digitalization and sustainability of the sector - corporate - talgo.com
55.European Energy Innovation	Rail Use blue and yellow, if you want to make it green	118. Rail Use blue and yellow, if you want to make it green (europeanenergyinnovation.eu)
56.Railway Business Magazine	Europe's Rail Mission and Objectives	119. Europe's Rail Mission and Objectives - Railway Business Magazine (railbus.com.ng)
57.EurekAlert	Ultrasonic tech to develop safer railway trac	120. Ultrasonic tech to develop safer railway trac EurekAlert!
58.The Engineer	Rail sensor goes ultrasonic to grease the wheels	121. Rail sensor goes ultrasonic to grease the wheels (theengineer.co.uk)
59.MarketScreener	Talgo S A: Develops New Rolling Assemblies For Very High-Speed Trains, reduces weight by 50%	122. Talgo S A : Develops New Rolling Assemblies For Very High-Speed Trains, Reduces Weight By 50% MarketScreener
60.Elpais	Ready to run train is exported (in Spanish)	123. Se exporta tren listo para funcionar Compañías Cinco Días (elpais.com)
61.Larazon	Indra and Talgo promote a more digital and green train in Europe (in Spanish)	124. Indra y Talgo impulsan un tren más digital y verde en Europa (larazon.es)
62.Bolsamania	Indra and Talgo join a European railway innovation program of 1,200 million (in Spanish)	125. Indra y Talgo se unen a un programa europeo de innovación ferroviaria de 1.200 millones - Bolsamania.com
63.Elplural	Indra and Talgo join Europe's Rail, the largest European railway innovation program (in Spanish)	126. Indra y Talgo se incorporan a Europe's Rail, el mayor programa de innovación ferroviaria europea (elplural.com)
64.Diario De Sevilla	Indra and Talgo are involved in the new European Innovation Framework Program (in Spanish)	127. Indra y Talgo se implican en el nuevo Programa Marco de Innovación Europeo (diariodesevilla.es)
65.El Confidencial Digital	Indra and Talgo will be founding members of Europe's Rail a 1,200 million European Innovation program (in Spanish)	128. Indra y Talgo serán miembros fundadores de Europe's Rail, un programa europeo de innovación de 1.200 millones (elconfidencialdigital.com)

66.Reynek	What will be the future of the rolling stock sector in our region? (in Polish)	129. Rynek Kolejowy (rynek-kolejowy.pl)
67.CNN	Europe wants a high-speed rail network to replace airplanes	130. Europe wants a high-speed rail network to replace airplanes
	Europe wants a high-speed rail network to replace airplanes	131. Europe wants a high-speed rail network to replace airplanes
68.Knorr-Bremse	Knorr-Bremse as one of the key innovation driver of „Europe’s Rail” Innovation Program	132. Knorr-Bremse as one of the key innovation driver of „Europe’s Rail” Innovation Program
	Leading the field in rail freight automation: Knorr-Bremse tests new function and builds DAC prototypes	133. Leading the field in rail freight automation: Knorr-Bremse tests new function and builds DAC prototypes
69.ADIF Alta Velocidad Newsletter	ADIF and Adif-Alta Velocidad participate as Founding Members in the Europe’s Rail Joint Undertaking, which has replaced the previous European Union rail R&D&I program “Shift2Rail”	134. ADIF and Adif-Alta Velocidad participate as Founding Members in the Europe’s Rail Joint Undertaking, which has replaced the previous European Union rail R&D&I program “Shift2Rail”
70.Sustainable Bus	InnoTrans 2022. 95 per cent of the area booked, at least 12 buses on the Bus Display track	135. InnoTrans 2022. 95 per cent of the area booked, at least 12 buses on the Bus Display track
71.The BRAKE Report	Knorr-Bremse tests new function, builds DAC prototypes	136. Knorr-Bremse tests new function, builds DAC prototypes
72.Lok Report	Knorr-Bremse: InnoTrans 2022 under the motto "Get into the Flow" (in German)	137. Knorr-Bremse: InnoTrans 2022 under the motto "Get into the Flow"
	Knorr-Bremse: Innovative electrical contact clutch for the Digital Automatic Clutch (DAC)	138. Knorr-Bremse: Innovative electrical contact clutch for the Digital Automatic Clutch (DAC)
	GATX: Optimization developments with new operational tests for the digital automatic coupling	139. GATX: Optimization developments with new operational tests for the digital automatic coupling
73.ProRail	ProRail and NS are working on transforming Europe's spoorweg system (in Dutch)	140. ProRail and NS are working on transforming Europe's spoorweg system
74.UNN - United News Network GmbH	Selectron Systems AG is with Knorr-Bremse at InnoTrans 2022: Innovation drivers with convincing solutions at the world's largest rail transport trade fair (in German)	141. Selectron Systems AG is with Knorr-Bremse at InnoTrans 2022: Innovation drivers with convincing solutions at the world's largest rail transport trade fair
75.Construction Cayola	InnoTrans 2022: an expected 13th edition (in French)	142. InnoTrans 2022: an expected 13th edition

76.FerPress	Europe's Rail announces its Call for Proposals 2022-2 at InnoTrans (in Italian)	143. Europe's Rail announces its Call for Proposals 2022-2 at InnoTrans
	Europe's Rail brings innovative railway solutions to Berlin (in Italian)	144. Europe's Rail brings innovative railway solutions to Berlin
	Europe's Rail awards six grants for its first Call for Proposals 2022-1 (in Italian)	145. Europe's Rail awards six grants for its first Call for Proposals 2022-1
77.Repubblica Economia	FS Group, six 568 million research and innovation projects funded by Europe's Rail (in Italian)	146. FS Group, six 568 million research and innovation projects funded by Europe's Rail
78.Agenzia stampa Mobilità	Europe Rail will finance six projects in the first call for tenders Investment of 568.4 million Euros, RFI among the winners (in Italian)	147. Europe Rail will finance six projects in the first call for tenders Investment of 568.4 million Euros, RFI among the winners
79.'SNCF	Europe's Rail: 6 Innovation Programmes Selected for the First Call for Projects (in French)	148. Europe's Rail: 6 Innovation Programmes Selected for the First Call for Projects
80.Teleborsa	FS Group, six 568 million research and innovation projects funded by Europe's Rail	149. FS Group, six 568 million research and innovation projects funded by Europe's Rail
81.Bolsamania	Indra and Talgo join a European railway innovation program of 1,200 million (in Spanish)	150. Indra and Talgo join a European railway innovation program of 1,200 million
82.Rail Passion	Autonomous trains being tested on the Hamburg S-Bahn network (in French)	151. Autonomous trains being tested on the Hamburg S-Bahn network
83.elEconomista.es	Thales leads a European project to improve train safety (in Spanish)	152. Thales leads a European project to improve train safety
84.FS News	FS Group, six research and innovation projects funded by Europe's Rail (in Italian)	153. FS Group, six research and innovation projects funded by Europe's Rail
85.Trafikverket	Europe's Rail grants funding for railway research in its first round of applications (in Swedish)	154. Europe's Rail grants funding for railway research in its first round of applications
86.InnoTrans Daily	Europe's Rail presents new "Catalogue of Solutions"	155. Europe's Rail presents new "Catalogue of Solutions"
87.Business Wire	The Worldwide Railway System Industry is Expected to Reach \$30.9 Billion by 2027 - ResearchAndMarkets	156. The Worldwide Railway System Industry is Expected to Reach \$30.9 Billion by 2027 - ResearchAndMarkets.com
88.Urban Transport	Siemens begins digitalization and automation for driverless regional trains	157. Siemens begins digitalization and automation for driverless regional trains
89.Notified	Railway System Market by System Type, Transit Type, Application and Region - Global Forecast to 2027	158. Railway System Market by System Type, Transit Type, Application and Region - Global Forecast to 2027

90. Yahoo Finance	Global Railway System Market (2022 to 2027) - Government Support for Alternative Fuel-Powered Railway Operations Presents Opportunities	159. Global Railway System Market (2022 to 2027) - Government Support for Alternative Fuel-Powered Railway Operations Presents Opportunities
	The global railway system market is estimated to grow at a CAGR of 4.2%, from USD 25.1 billion in 2022 to USD 30.9 billion by 2027	160. The global railway system market is estimated to grow at a CAGR of 4.2%, from USD 25.1 billion in 2022 to USD 30.9 billion by 2027

External events participated to by the Joint Undertaking in 2022

In 2022, the JU participated to major events across Europe and beyond, presenting concrete results achieved by JU Members together with other key stakeholders.

Institutional events

Connecting Europe Days – 28-30 June – Lyon, France

Together with SESAR 3 JU, we organised a dedicated panel discussion on multimodal transport systems for the benefit of European citizens.

Furthermore, our Executive Director took part in a panel discussion on 'Enhancing Sustainable, Multimodal Freight Transport'.

Our Head of Programme took part in a panel discussion on 'Research and Innovation for a modern and resilient infrastructure'.

Within the frame of the European Year of Youth, visitors had the opportunity to listen to a pitch delivered by our Executive Director and Programme Trainee who discussed how to achieve climate neutrality with rail.

JU events

Europe's Rail Info Day Call 2021-1 – 16 March, online

The event gave participants an overview of the aims of the Europe's Rail Research & Innovation Programme and introduced them to the possibilities to get involved in ensuring rail is the preferred mobility choice in Europe. During the day, participants were able to find out about Europe's Rail upcoming funding opportunity 'Europe's Rail Call for Proposals 2022-1'.

This event was aimed at interested companies and research organisations that wish to carry out collaborative research and innovation projects in the area of railway mobility.

Europe's Rail Info Day System Pillar – 3 May, online

The event gave an overview of the aims of the System Pillar within Europe's Rail, and its respective Call for Tender worth up to €45 million. Additionally, it was an occasion to learn about the set-up of the Tender, including its three lots. During the event, there was an opportunity to ask questions and find out about the evaluation criteria of the Call.

Europe's Rail Info Day Call 2022-2 – 19 October, online

Europe's Rail 2nd Info Day took place on 19 October 2022, online. The event gave an overview of the aims of the Europe's Rail Research & Innovation Programme and introduced the possibilities to get involved in ensuring rail is the preferred mobility choice in Europe. During the day, participants were able to find out

about Europe's Rail upcoming funding opportunity 'Europe's Rail Call for Proposals 2022-2', worth €35.8 million. Organisations working in the field of research and science were invited to attend the Info Day.

Europe's Rail Innovation Days – 7-9 December, online

For the first time organised under the new Europe's Rail name, the event was an opportunity for the European railway and transport community to get first-hand access to the latest results coming from the projects of our predecessor programme Shift2Rail. The work performed in the Shift2Rail Programme contributes in different aspects to deliver solutions answering to the energy crises, as well as how rail is positioning itself as the key element of the future mobility, with a horizon up to 2050.

The projects working to deliver the future of railway in Europe presented concrete results that are paving the work of Europe's Rail, during dedicated webinar sessions. Participants learned more about traction systems, running gear, KPI models, smart metering, switches and crossings, booking and ticketing solutions, multimodal travel, artificial intelligence, blockchain, condition-based maintenance, intelligent video gate and much more.

External events

In 2022, the JU participated to major rail, transport and research events, presenting concrete results achieved by JU Members together with other key stakeholders. A selection of the most high-profile and relevant events is listed below.

2022 ITF Annual Consultation Day with International Organisations – 20 January, Leipzig

EU-Rail ED along with other key ITF partner international organisations from the transport sector and beyond, engaged in a dialogue on the most pertinent issues that should be addressed in the programme of the 2022 Summit on "Transport for Inclusive Societies".

European Railway Award – 8 February, online

EU-Rail received a 'Certificate of Outstanding Achievement' during the European Railway Award 2022.

Modus multimodality workshop – 14 February, online

Executive Director delivered a keynote speech at the Modus project workshop: "What could future air-rail multimodal mobility look like?". Discussions focused on the technological and operational solutions that answer the needs of passengers and supply chain.

Europe's Rail Launch Ceremony during the French Railway Summit – 21 February, Paris, France

The official launch of Europe's Rail Joint Undertaking took place during the European Railway Summit, organised by SNCF in the context of the French Presidency of the European Union, on 21 February 2022 in Paris.

During the ceremony, representatives from the European Commission and the rail sector, including Europe's Rail 25 Founding Members, expressed their expectations for Europe's largest rail research and innovation programme. The launch ceremony was attended by several Ministers of Transport of the Member States, including Jean-Baptiste Djebbari, French Minister Delegate for Transport and President of the Transport Council, and watched by hundreds of online viewers.

The event was kicked-off by speeches from the European Commissioner for Transport, Adina Vălean and European Commission's Director-General for Mobility and Transport, Henrik Hololei.

HYPERNEX final conference – 23 February, online

Executive Director took part in a panel discussion that focused on the "Next steps beyond HYPERNEX".

International Seminar for the commemoration of 26th anniversary of KRRI – 24 February online

Executive Director participated at the International Seminar for the commemoration of 26th anniversary of KRRI. In his video message, he talked about Europe's digital transformation strategy and its progress in the railway market, as well as EU-Rail's important role.

French Presidency of the Council of the European Union event – 24 February, Paris

Executive Director took part in the French Presidency of the Council of the European Union event, where best practices in supporting rail freight in Europe were discussed, on 24 February 2022. During the innovation panel, exchanges, focusing on future solutions that could boost the development of rail freight and identify priorities at European level took place.

Fifth GCC – EC Joint Workshop for Railways – 7 March, Online

Executive Director presented the objectives and work plan of the new Europe's Rail Programme during the 5th FCC-EC Joint Workshop for Railways on 7 March 2022.

Together with the Head of Rail Safety and Interoperability Unit at Directorate General for Mobility and Transport, he talked about the structure of Europe's Rail, with an emphasis on the System Pillar, the Innovation Pillar, and the Deployment Group. Exploratory research, such as hyperloop and other possibilities for cooperation with GCC were also discussed.

Women in Rail Awards - 8 March, Brussels

The ceremony of the 1st Women in Rail Awards took place on 8 March 2022, on the International Women's Day. Executive Director highlighted the importance of gender balance and diversity in the rail sector, including research and innovation. He announced that the winners of the four categories, will join the Europe's Rail team at InnoTrans 2022.

STARS advisory group meeting – 11 March, online

Head of Programme took part in the STARS advisory group meeting held on 11 March 2022. The Advisory Group meeting was dedicated to discussing the results of the 'Technological Innovation Analysis' listing the innovation roadmaps and technological challenges of the railway and multimodality meta-ecosystem and identify the specific advanced technologies they can be utilised.

Rail4Future Knowledge Transfer Event – 15 March, online

Executive Director participated to the Knowledge Transfer event, dedicated to 'Rail4Future: Resilient Digital Railway Systems to enhance performance' on 15 March 2022.

He addressed the importance of digitalisation, simulation, virtualisation, data-exchange, and digital twins in the railway sector. He also highlighted the importance of the digital interoperability across the sector and domains.

UNIFE Technical Platform meeting – 17 March, Brussels

Executive Director took part in the UNIFE Technical Platform meeting on 17 March 2022. He presented the new EU-Rail programme as well as our recently launched Call for Proposals. He underlined that EU-Rail will deliver new technologies, solutions and services to transform rail in Europe.

IN-MOVE Kick Off Meeting 2022 – 17 March, online

Executive Director took part in the IN-MOVE Kick Off Meeting on 17 March 2022. He spoke about Europe's Rail Joint Undertaking as a real example of a public and private collaboration initiative to boost innovation in the railway sector.

Europe's Rail National Info Day in Finland – 22 March, Helsinki, Finland

Head of Programme took part in Europe's Rail National Info Day in Finland on 22 March 2022. He talked about Europe's Rail partnership and its first Call for Proposals. He highlighted the EU objectives to improve the railway sector, as well as the key flagship areas and destinations of the EU-Rail partnership.

STARS meeting at CETIC – 23 March, online

Head of Programme took part in the STARS meeting at CETIC on 23 March 2022.

During the meeting, he gave an overview of the new EU-Rail programme, with focus on expectations and vision for the future. It was also an opportunity for Small and Medium Size Enterprises to learn how they can leverage from the partnership.

Railway Days 2022 – Club Feroviar Investment Summit – 24 March, Bucharest

Europe's Rail took part in the Railway Days 2022 – Club Feroviar Investment Summit in Bucharest on 22-24 March 2022.

Executive Director gave an opening speech highlighting the importance of an efficient European railway system.

Seconded National Expert & Programme Manager also participated by taking part in a panel discussion focused on the contribution of the rail sector to the current climate challenges, and the Union strategies addressing them.

Automation in the supply chain at the service of competitiveness – 29 March, Brussels

Executive Director took part in the Logistics for Wallonia event 'Automation in the supply chain at the service of competitiveness' on 29 March 2022. He discussed the innovation priorities of the railway industry at European level.

The event was an opportunity for organisations to review the contributions of automation in the supply chain and to share examples of implementation.

Tauro Midterm Conference – 1 April, online

Head of Programme attended the mid-term conference of our Innovation Programme X project TAURO on 1 April 2022. The TAURO project is shaping the future of European rail transport by developing the technologies required to make autonomous rail transport a reality.

Modern Rolling Stock Conference – 4 April, Graz

Executive Director gave a keynote speech at the Modern Rolling Stock Conference on 4 April 2022 in Graz. The objective of the Conference was to discuss the latest state-of-the-art developments and constructions of rail vehicles of passenger transport, local passenger transport, freight transport as well as of trams, regional trains, and subways.

Decarbonisation Day – 5 April, Saintes

Executive Director presented Europe's Rail vision in the context of decarbonising Europe's transport sector during Decarbonisation Day in Saintes, France on 5 April 2022. He discussed how rail transport can go even further in lowering carbon usage.

European Railway Clusters Initiative webinar – 6 April, online

Programme Manager gave an overview of our research and innovation activities during the European Railway Clusters Initiative (ERCI) webinar on 6 April 2022.

Participants had the opportunity to learn more about the current Call for Proposals open until 9 June 2022.

She was joined by Cluster coordinator of DITECFER who presented the possibilities that the ERCI can provide to SMEs.

Horizon Europe & Europe's Rail Webinar – 21 April, online

Executive Director participated in the Spanish Railways Technological Platform's webinar "Railway Sector in Horizon Europe & Europe's Rail" on 21 April 2022.

During the event he introduced the Europe's Rail partnership and provided information about the Calls for Proposals.

3rd RFC Network – 28 April, online

Head of Programme, took part in the 3rd RFC Network-RNE session on 28 April 2022. During the session he presented the ambitious objectives of the Europe's Rail partnership.

French National Safety Authority, EPSF – 29 April, Paris

Executive Director and Programme Manager and Seconded National Expert gave a presentation to the staff of the French National Safety Authority, EPSF on 29 April. During the workshop the staff had the opportunity to learn about our activities in rail research and innovation, focusing on the development of railway technical rules and standards

ERTMS Conference – 26-28 April, Valenciennes

Europe's Rail was present at the ERTMS 2022 Conference, in Valenciennes, France on 26-28 April 2022.

Representatives from Europe's Rail moderated workshops on implementing ATO over ETCS, as well as workshops on the new EU-Rail Programme and the System Pillar and Innovation Pillar.

Future and Performance of Cross-Border Freight and Passenger Rail Transport Conference – 3 May, Strasbourg

Executive Director took part in the CCI Alsace Eurométropole Conference on the future and performance of cross-border rail transport on 3 May in Strasbourg.

He joined a discussion on the performance and competitiveness of passenger and freight rail services for companies in Europe.

Talgo Innovation Awards Conference: I Jornada – 5 May, online

Programme Manager and Seconded National Expert gave a presentation on the technological opportunities in mobility at the joint conference organised by our Founding Member Talgo and IN-MOVE Railgroup, on 5 May. This event focussed on the needs in mobility and open innovation to drive citizen-centric improvements.

International Conference on Disaster Resilient Infrastructure 2022 – 5 May, online

Head of Programme participated in the CDRI 2022 Transport session on May 5. During this session, he gave his perspective on transitions within the transport sector and talked about the steps we have taken through our funded projects to improve disaster and climate resilience of rail infrastructure.

The State of the Union – 5-7 May, Florence

Executive Director participated in the 12th edition of The State of the Union on 5-7 May 2022 in Florence. He joined a discussion on how the stimulus package, a key tool in aiding the recovery from the COVID-19 pandemic, can accelerate the decarbonisation of transport with railways playing a central role.

Portugal Railway Summit 2022 – 16 May, Lisbon

Head of Programme took part in the Portugal Railway Summit on 16 May 2022. He gave a speech on research and innovation with an emphasis on technological challenges Europe's rail sector faces.

The event focused on investment plans and the ecological challenges we have to face, providing the discussion of priorities and new perspectives of railway innovation.

International Transport Forum – 18 May, Leipzig

Executive Director gave a keynote speech at the International Transport Forum session on 'Making the Links: Promoting supply chain access' on 18 May in Leipzig.

During his panel he explained how well-connected and well-maintained infrastructure, inter-modality and vehicle technology can improve efficiency, reduce emissions and promote supply chain access.

EU Light Rail Congress – 18 May, Zaragoza

Programme Manager and Seconded National Expert gave a presentation at the European Light Rail Congress on 18 May in Zaragoza. He discussed the work of Europe's Rail Joint Undertaking and gave insights in new technologies that are being used in light and urban rail.

The event brought together many key rail experts from across Europe for discussions around light rail being a key driver to sustainable mobility.

IX European Rolling Stock Forum – 19 May, online

Executive Director gave a keynote speech at the IX European Rolling Stock Forum on 19 May. He discussed innovations that will help us decarbonise and digitalise railways in Europe.

The European Rolling Stock Forum is one of the largest events in Central and Eastern Europe devoted to modern rolling stock.

European Startup Prize for Mobility Prize Ceremony – 19 May, Paris

As a proud supporter of the European Startup Prize for Mobility, Europe's Rail participated to the Final Prize Ceremony on 19 May in Paris.

In presence of Vice-Presidents Maroš Šefčovič and Lilyana Pavlova, Commissioner Helena Dalli, and Chair of the Transport Committee Karima Delli, our Executive Director awarded a special prize entitled 'Rail Mobility', highlighting the rail sector's most innovative technologies.

Together with the European Commissioner for Equality, Helena Dalli, he also took part in a roundtable session discussing how can we ensure ethical human-centric innovation according to European values.

ERRAC Plenary session – 24 May, online

Head of Programme gave a speech about the status and upcoming priorities of the Europe's Rail Joint Undertaking, at the ERRAC Plenary on 24 May.

ERRAC communicates the railway sector's common research and innovation vision to the European institutions and other relevant stakeholders. It aims to shape a favourable funding landscape for railway research initiatives.

Delivering Digital Automatic Coupling in Europe – transformation of rail freight – 25 May, Vienna

Executive Director joined the Digital Automatic Coupling (DAC) forum titled 'Delivering Digital Automatic Coupling in Europe – transformation of rail freight' on 25 May in Vienna. The event was organised jointly by SEESARI and our Founding Member OEBB, in close collaboration with the European DAC Delivery Programme, enabled by Europe's Rail.

He discussed the opportunities, and challenges for that need to be addressed to ensure a full transformation of European rail freight.

The forum addressed the importance of introducing the DAC in Europe by 2030.

DAC Data & Energy Workshop – 30 May, online

The Digital Automatic Coupling (DAC) Data and Energy workshop took place on 30 May 2022.

Jointly organised by the European DAC Delivery Programme (EDDP) and our Innovation Programme 5 DACcelerate project, the workshop addressed the overall benefits of DAC deployment and its use cases directing towards a planned roadmap, with a particular focus on the data and energy needs of DAC.

Attendees were able to ask questions and interact with the experts.

Smart Rail Innovation Program 2022 – 2025 – 30 May, online

Executive Director gave a keynote speech during the Smart Rail Innovation Program 2022 – 2025 on 30 May. During the event, the Canadian Urban Transit Research & Innovation Consortium (CUTRIC) held consultation sessions in several technology areas to advocate, get support and further contribute to innovative projects in the Smart Rail Innovation Program 2022 – 2025.

International Railway Summit – 31 May and 1 June, Berlin

Executive Director moderated a panel discussion during the 11th International Railway Summit on 31 May in Berlin, Germany. He discussed how rail transport can lead to a greener future.

Additionally, Head of Programme took part in a panel discussion on June 1st exploring how we can transform rail by 2030 and how to get on track for climate targets. He also moderated a session on what rail should be doing to attract public and private investments.

World Congress on Rail Research – 6-10 June, Birmingham

Europe's Rail joined the World Congress on Rail Research, taking place on 6 – 10 June 2022 in Birmingham, United Kingdom as a major supporter with a 64 sqm stand showcasing several demonstrations.

During the event we hosted a high-level ceremony and discussions on our stand with representatives from the European Commission, Delegation of the European Union to the United Kingdom, representatives from the Birmingham local authorities and our Members and partners.

Programme included:

- Participation in plenary sessions
- Masterclasses on Digital Automatic Coupling and System Pillar led by Europe's Rail experts
- Professional Growth Sessions led by the Chair of our Scientific Committee Professor Angela Di Febraro
- Pitch sessions on Europe's Rail stand. We congratulate Jason Zheng from Bristol University whose pitch was valued the highest by the audience
- High-level wrap up session in the presence of João Vale de Almeida EU Ambassador to the United Kingdom

Digital Automatic Coupling event – 7 June, Strasbourg

Executive Director participated in an event dedicated to Digital Automatic Coupling on 7 June, in Strasbourg.

Representing the views of the European Union he gave a speech about the importance of this game-changing rail freight solution and its crucial role in improving safety, efficiency, and sustainability of rail freight.

Digital Automatic Coupling – DAC Conference – 16 June, Paris

Executive Director took part in a conference dedicated to digital automatic coupling, organised by AFWP, UIP and UIC on 16 June, in Paris. The conference, focused on the DAC, its benefits and its future deployment in Europe.

UNIFE General Assembly – 16 June, Paris

Executive Director and Head of Programme participated in the UNIFE General Assembly on 16 June, in Paris. He discussed the competitiveness of the European rail supply industry.

UNIFE's General Assembly covered topics such as digitalisation and innovation, interoperability, and sustainable mobility.

Cross-Cutting Activities projects final event – 14 June, Brussels

Our Cross-Cutting Activities projects, Ben@Rail and IMPACT-2, organised their final event on 14 June.

During the event, attendees discovered the expected benefits of the Europe's Rail programme, and how rail will move into the future through research.

It was also an opportunity to learn about the mid-term achievements of our FINE-2 project.

Programme Manager spoke about the objectives of the Europe's Rail programme and summarised some of the key results coming from all three projects.

ETCR conference – 11 July, Bruges

Head of Programme participated to the ETCR conference at the Colleges de Bruges at the event co-organised with ERA, delivered a presentation on innovation and cybersecurity

Gender Equality and the Role of Women in Decarbonising Transport webinar – 12 September, online

Our Chief Stakeholder Relations and Dissemination took part in the "Gender Equality and the Role of Women in Decarbonising Transport" webinar organised by the International Transport Forum (ITF) and the FIA Foundation on 12 September.

The webinar discussed the links between gender equality, transport and climate change.

It was also an opportunity to explore how mainstreaming gender considerations into all decarbonising transport policy-making decisions can help us to deliver on climate action goals.

AI4RAILS 2022: 3rd International workshop on Artificial Intelligence for Railways – 12 September, Zaragoza

The 3rd International workshop on Artificial Intelligence for Railways took place on 12 September in Zaragoza, Spain.

The workshop gathered the best ideas, comments and experiences related to the adoption of artificial intelligence in railways.

The event was supported by our Innovation Programme X project, RAILS.

TRA VISIONS 2022 Event – 13 September, Brussels

Our Programme Manager took part in the shortlisting panel for the TRA VISIONS 2022 research competitions for senior and young researchers on 13 September in Brussels.

TRA VISIONS 2022 is an initiative of the European Commission and part of the bi-annual Transport Research Arena (TRA) conference, which will take place on 14-17 November in Lisbon.

InnoTrans – 20-23 September, Berlin

Together with its Members and partners, Europe's Rail showcased innovative rail solutions of the Shift2Rail Programme and presented the new Joint Undertaking on rail research and innovation launched formally in Paris on 21 February. InnoTrans is the most important global event for the rail sector and the world's leading trade fair for transport technology, with a focus on rail transport and infrastructure, as well as public transport.

During the event, we showcased more than 20 live and permanent demonstrations on results that are expected to shape the future of rail, including automated train operation, translation tool for cross border travel, DAC, Travel Companion on booking and ticketing, virtual reality set on noise abatement, innovative doors and panels, lightweight seats, among others.

To put all these innovations in the spotlight, we also launched the Catalogue of Solutions, 2022 Edition. The Catalogue brings together the innovative solutions and approaches which Shift2Rail Members and projects' participants are delivering to transform the rail systems. While the first edition was launched during the World Congress on Railway Research back in 2019 in Japan and in presence of EU Ambassador Patricia Flor, the updated publication provides a much more in-depth timeline for market deployment.

We also had a number of activities throughout the event, one of them being hosting a high-level session titled Digital Automatic Coupling – Transforming Europe's Rail Freight, organised in collaboration with our Founding Member Deutsche Bahn and the European DAC Delivery Programme. It was an opportunity to discuss the benefits of the DAC solution and how to best prepare for its roll-out, including the societal impact and investment scenarios.

Shift2Rail have always supported initiatives that seek to improve gender balance in the railway sector. Shift2Rail was one of the very first supporters of the Women in Transport initiative led by the European Commission. Back in 2018 Shift2Rail announced the first edition of the 'Women in Rail Research & Innovation Award'. With this initiative, S2R recognised the work of a woman, or a group of people led by a prominent woman, having demonstrated her professional capacity to move the railway industry forward and breaking obstacles for other women to access. The award was presented during InnoTrans 2018 in presence of the Transport Commissioner at the time. This time we took the Women in Rail Award winners with us to InnoTrans at the Women in Mobility Luncheon. The event was an opportunity to connect female role models to enhance visibility, and consequently foster innovation through diversity. It brought together women leaders who influence the transport and mobility sector through their specialist knowledge and leadership skills.

Furthermore, Europe's Rail took part in various UNIFE events and participated to the Hyperloop Conference together with the representatives from the European Commission.

Seminar "Enjeux des technologies radio" by Université Gustave Eiffel – 29 September, Lille

Head of Programme presented the EU-Rail programme and results in participating to a roundtable on the future communication system.

European DAC Day – October, Prague

Against the backdrop of the Czech Presidency of the Council of the European Union, the European Digital Automatic Coupling (DAC) Day organised by Lindholmen Science Park in collaboration with our Founding Member Trafikverket, brought together key rail stakeholders from Central and Eastern Europe. The event, organised in the frame of our DACcelerate project, was supported by Europe's Rail and the European DAC Delivery Programme (EDDP).

Attendees experienced a demonstrator train in VR and learned about the benefits and challenges of the implementation and the status of the demonstrations. The event took place in conjunction with the International Rail Forum & Conference

The European DAC Day gathered parties crucial for the future of a successful and efficient DAC migration and financing scenarios. Click below to read our recently published article on the DAC Day and discover the main takeaways from the event

IRFC 2022 – 6 October, Prague

Against the backdrop of the Czech Presidency of the Council of the European Union, our Executive Director, moderated a panel discussion during the IRFC 2022 on 6 October in Prague, Czech Republic. The discussion titled “EU’s Research and Innovations in a Globalised World” focused on EU-Rail and the importance of research and innovation in the sector. We are also proud to have supported a dedicated coffee corner at the event.

CER Conference & Exhibition ‘The Track to a Successful TEN-T’ – 11 October, Brussels

Europe’s Rail joined the conference and exhibition opening of the Community of European Railway and Infrastructure Companies (CER) event on “Track to a successful TEN-T for a sustainably connected Europe” on Tuesday 11 October in Brussels, Belgium.

The event discussed the Trans-European Transport Network (TEN-T) and why it is essential for the coordination of major rail projects, physical and digital across Europe and how it will shift more passengers and freight to sustainable modes like rail.

STAFFER mid-term conference – 13 October, Brussels

Executive Director took part in the STAFFER mid-term conference, contributing to a panel discussion on “How to make the railway sector attractive for young people?” on 13 October in Brussels, Belgium.

University students had the opportunity to ask questions focused on the STAFFER project, its results, as well as future plans.

Attendees were also able to hear the results of initial benchmarking activities and skills needs assessments.

Railways Days Summit – 17 October, Bucharest

Head of Programme presented the EU-Rail programme and results in the Railways Days Summit as well as key opening the conference at the Polytechnic University. Panel discussions also held with transport ministry representative, CER, UIRR, OTIF.

The 17th edition of the Railway Days brought together 350 representatives of the railway sector.

TRANS4M-R 1st plenary – 18 October, Munich

Executive Director and Senior Programme Manager took part in the first plenary meeting of the new EU-Rail project, TRANS4M-R, on 18 October in Munich.

The event marked the inception of TRANS4M-R, a project which intends to stimulate and support innovations like the Digital Automatic Coupler for the digital freight train, Digital Shunting Operations, and Automatic Train Operations – that will increase the sector’s flexibility, efficiency and competitiveness.

Our Founding Members, KNORR-BREMSE, Deutsche Bahn, and ÖBB, hosted the event and gathered around 100 people from the rail industry to further strengthen the cooperation on game-changing rail freight technologies.

4th SmartRaCon Workshop – 20 October, online

Programme Manager presented new approaches for train control, command and signalling systems at the 4th SmartRaCon Workshop on 20 October.

CEIT, RAILENIUM, NSL, and DLR have founded the Smart Rail Control (SmartRaCon) consortium to develop new concepts, approaches and technologies. During the workshop, participants received a scientific view of the progress and results regarding SmartRaCon involvement in Shift2Rail.

APRE 2022 Annual Conference – 27 October, online

Executive Director participated in the APRE 2022 Annual Conference titled “Towards a new future, Innovating in complexity” on 27 October.

He joined a round table discussion on “European partnership - where we are?” and talked about the Horizon Europe programme and our Call for Proposals 2022-2.

SITCE 2022 – 3 November, Singapore

Executive Director took part in SITCE 2022, the leading public transport event in the Asia Pacific region, on 3 November in Singapore.

He joined a session on "Rail Success Stories: Rail as the Backbone of Mobility" with the objective to provide positive examples of how the rail sector's disruptive potential can be exploited, generating added value not only for customers, but also for regions and cities and the society.

Hyperloop Technology for Europe – 7 November, Brussels

Executive Director participated in the Hyperloop Technology for Europe Conference on 7 November in Brussels.

He gave a keynote presentation on Hyperloop as an innovative transport technology during a session titled “Development of Large-Scale Research Infrastructure in Europe”.

Next Stops for European Rail – 9 November, Brussels

Head of Programme took part in the Next Stops for European Rail conference, held on 9 November at the European Parliament. He explained the activities of the Europe's Rail R&I programme.

Scandinavian Rail Optimisation Conference – 9 November, Stockholm

Executive Director spoke at the Scandinavian Rail Optimisation on 9 November in Stockholm, Sweden.

He discussed the Europe's Rail programme and its impact and opportunities for the Scandinavian railway network.

The conference addressed the concepts and lessons learned for digital success, as well as the importance of how data is optimised to develop an intelligent infrastructure and enhance the availability of rolling stock assets in the Scandinavian region.

Transport Research Arena (TRA) – 14-17 November, Lisbon

Europe's Rail took part in TRA 2022, the largest European research and technology conference on transport and mobility on 14-17 November in Lisbon, Portugal.

Visitors had the opportunity to test our demonstrations coming from the Shift2Rail Programme including the Travel Companion application, auralisation and visualisation tool, a language tool on cross-border travel, a lightweight single axle running gear frame and more.

During the conference, we had the pleasure of welcoming Mr Pedro Nuno Santos, Portugal's Minister for Infrastructure and Housing on our stand and introduce him to the objectives of the Europe's Rail programme for a green and digital future. We were also honoured with the presence of Mr Walter Goetz, the Head of Cabinet of European Transport Commissioner Adina Vălean. Mr Goetz had a tour of our stand and exchanged ideas with our Head of Programme, our Founding Members and representatives from our States Representative Group.

In addition, Executive Director took part in a strategic session on Artificial Intelligence for Smart and Sustainable Mobility and Head of Programme took part in an invited session on motivating companies, academia and research organisations to participate in EU research.

Europe's Rail is also supporting the TRA VISIONS 2022 competition for young researchers. Executive Director handed out the young researchers prizes in the rail category during the Opening Ceremony.

European Partnership Stakeholder Forum – 15-16 November, Brussels

Head of Programme together with Communication Trainee, attended the first European Partnership Stakeholder Forum co-organised by ERA-LEARN and the European Commission on 15-16 November in Brussels.

He presented the Europe's Rail R&I programme during the poster sessions. Our presence was an opportunity for networking, broadening engagement, sharing experiences, and discussing policy and practical dimensions related to the EU-Rail partnership.

The forum focused on the review of the first year of partnerships, like Europe's Rail, and how they can contribute to the green and digital transitions, as well as increasing Europe's resilience.

World Passenger Festival – 16-18 November, Amsterdam

Head of Programme joined the World Passenger Festival on 16 – 18 November in Amsterdam, The Netherlands. He joined a panel on “Creating the conditions for widespread modal shift to public transport: A hopeless pipedream or realistic vision?”

The conference brought transport leaders together to discuss the technologies, strategies and opportunities which can encourage a return to public and shared transport usage.

Working Party on Rail Transport – 17 November, Geneva

Executive Director took part in the Working Party on Rail Transport workshop organised by UNECE on 17 November in Geneva, Switzerland.

He discussed the impact of climate change on railways and shared good practices on minimising disruptions and reducing safety risks resulting from extreme weather.

Workshop participants were also invited to identify technological developments and procedural innovations to mitigate the harmful effects that the climate change has on the railways.

DAC Seminar – 23 November, Bratislava

Executive Director attended the DAC Seminar organised by Železničná spoločnosť Cargo Slovakia on 23 November in Bratislava, Slovakia.

He presented the Europe's Rail partnership, and the work our R&I programme is doing regarding rail freight transport.

The seminar was dedicated to the Digital Automatic Coupling (DAC) and attendees had the opportunity to learn exactly what the DAC is and what the plans for it are in the Slovak railway. The European DAC Delivery Programme, enabled by Europe's Rail, was also presented.

Danube Region Transport Days 2022 – 28-29 November, Ljubljana

Programme Manager attended the Danube Region Transport Days 2022 titled “Towards energy efficient, sustainable transport” on 28 and 29 November 2022 in Ljubljana, Slovenia.

He presented the Europe's Rail vision for a flexible, sustainable, and integrated European railway network.

The conference, co-organised by UNECE, the Transport Community and the OJP4Danube Consortium, addressed the incentives available for the transport sector to reduce energy consumption.

Rail Live – 29 November – 1 December, Malaga

Over three days – from 29 November to 1 December – Europe's Rail took part in Rail Live, the industry event on innovation, investment, and digital transformation.

Executive Director gave a keynote speech on the future of sustainable transport networks.

Programme Manager gave a presentation on how we are creating the conditions for Rail Freight to double by 2030 with the focus on condition-based maintenance and digital automatic coupling.

Senior Programme Manager moderated a Rail Live panel discussing the roadmap for the future of FRMCS, 5G technology and how operators and infrastructure managers can best prepare for the challenges and opportunities of the Future Railway Mobile Communication System.

Communication statistics in 2022

Website User statistics

JU's website was visited by 134,123 unique visitors in 2022, which is a significant increase compared to 129,197 unique visits in 2021. Most visitors (78,762) were based in Europe, followed by Asia (12,296) and North America (7,264). The largest number of visitors by country were based in Belgium, followed by Germany, the United States, Spain and China. JU's website was mostly visited by people using a personal computer (117,078 visitors), second most popular device being smartphone (10,132 visitors). A low bounce rate (28%) on the JU website indicates that visitors find the website content interesting and informative. Average time spent on the JU website in 2022 was 2,4 minutes.

Newsletter

The 2022 editions continued to include more project results and news regarding final events and conferences deriving from information fed to the Communication Team by the Programme Unit and the S2R projects themselves. Organisation of events was a key priority of the Communication Team in 2022 due to the number of activities resuming post Covid-19. This resulted in newsletter content saturated with promotional material about Europe's Rail participation to various events and conferences. For instance, a new section titled 'Photo gallery' was included in the June newsletter. Furthermore, a dedicated section on InnoTrans was created for the September newsletter. The average number of articles per newsletter has remained at high number of 26 in 2022, clearly showcasing the increasing involvement of Europe's Rail in various activities in Europe and beyond.

The readership of the JU newsletter has steadily increased throughout the year from 1,767 in January 2022 to 1,857 at the end of 2022, reaching a 6% increase. Various factors have fed into the growth of the audience including JU's participation to numerous events, more promotion of the newsletter by staff through their meetings and networks, and increased promotion of the newsletter and its individual articles on JU's corporate social media channels and mentions in the press and media.

Social media

In 2022 the JU continued building its presence on social media, now under a new name – Europe's Rail. Generally, the JU's social channels are used to engage with the rail community and other stakeholders, including the end users. Furthermore, it is important to mention that the visual identity of all channels – Twitter, LinkedIn, Facebook, YouTube – was updated, incorporating the new graphic guidelines developed for the new JU. In 2021, EU-Rail Communication Team introduced more in-depth content on its LinkedIn account due to the many deliverables and results coming from the projects. Such content was well-received by the audience as it consists of mostly technical stakeholders and engineers. During 2022 EU-Rail has been aiming to constantly inform the already converted, while also reaching out to new interested stakeholders, in order to ensure a growing audience for JU activities. In 2022, the average number of tweets per month was 33.

The audiences JU targets on social media depend on the channels. While on Twitter the JU is followed by a wide audience with different backgrounds, LinkedIn attracts a more specialised community interested rather in technical details and longer in-depth articles. JU's Communication Team creates different content in order to tailor the message to these different audiences. On Twitter the JU shares daily events, short articles and posts illustrated with images and videos. On LinkedIn, however, the audience expects longer, more thought-provoking material including technical details about our innovations. 2022 saw a major growth in terms of LinkedIn popularity, proving it to be the most viewed social media channel of EU-Rail.

JU has also increased its presence on its YouTube channel. Efforts have been made to publish videos showing our innovations as well as recordings of our online events to ensure that even those who were unable to join, have access to the content. All video content developed by S2R projects specifically for InnoTrans was uploaded on the EU-Rail YouTube channel to ensure all stakeholders can access them to learn about the progress and achievements of the projects.

JU has increased the number of followers on all its social media channels during 2022. The largest increase in the number of followers was on LinkedIn where the JU got an impressive increase represented by 2.431 new followers. The total number of followers on LinkedIn is now 8.996. LinkedIn therefore has the biggest audience out of all JU's social media channels. On the other hand, JU's Twitter account has 4.701 followers out of whom 52 started following the JU account in 2022.

Throughout 2022, the JU has continued putting more effort into long-term social media planning to make sure that all relevant news is promoted through EU-Rail's social media platforms in a timely and effective manner. The JU also focused in 2022 on engaging more intensively with other relevant stakeholders on social media (DG MOVE, DG RTD, CINEA and other EU-institutions; Members and key associations) that helped to support the dissemination of JU messages and vice-versa. EU-Rail has had an especially successful collaboration with DG MOVE who have posted and re-shared the JU content on their Twitter account, which has more than 50.000 followers. This collaboration has intensified with the launch of Europe's Rail. Additionally, in 2022 more and more Founding Members have started promoting Europe's Rail on their social media accounts. This has resulted in a multiplier effect due to their high number of followers and reach. Such information sharing is made possible thanks to the close contact developed between the Communication team and Founding Members Communication Officers via the Communication Networks Meetings.

Just like in previous years, in 2022, JU also had at the heart of its strategy the promotion of the JU project results through its social media channels (see also Section 1.9). Thanks to the collection tool developed by the JU, projects are able to directly propose content for organic or re-shared posts. The projects are encouraged to send content directly to the Communication Team to ensure it is promoted across the social media channels in a timely manner. In 2022 the Communication Team also began testing dedicated Microsoft 365 Teams environments which could be used for collecting content from the projects for publication via social media. The initial pilot phase is foreseen in 2023.

Press

The JU published seven press releases in 2022, covering the launch of the Europe's Rail Joint Undertaking, Call for Proposals 2022-1, Call for Proposals 2022-2, the signing of a Memorandum of Understanding on the study 'Smart and Affordable High-Speed Services in the European Union', the award of the System Pillar Tender and Europe's Rail participation to InnoTrans (details of all press releases are available in Annex C).

In 2022, the JU was featured in more than 160 articles in a range of magazines, industry press and online media. JU's Communication Team has continued to build relations with journalists and editors from different media outlets to find ways for cooperation and to offer ideas for stories. In 2022, the JU saw an increased interest from the journalists who contacted Europe's Rail requesting content on various rail R&I priorities. JU's Communication Team has created a directory of over 100 journalists who often publish JU-related content. Additionally, the JU has developed an especially fruitful collaboration with journalists from the Railway Gazette, International Railway Journal, RailTech, Global Railway Review and Railway Pro.

In 2022, Europe's Rail continued paid partnership with Railway Gazette and BtoB Rail, covering Europe's Rail participation to InnoTrans. The magazines published three articles about Europe's Rail, as well as sent

out mailshots and promoted the JU on their social media channels, therefore, reaching even larger audiences.

In addition to JU's news about the launch ceremony of Europe's Rail Joint Undertaking, some of the most widely covered stories about the JU include the launch of the Call for Proposals 2022-1 and Call for Proposals 2022-2, the signature of the MoU and JU's participation to InnoTrans, Transport Research Arena and the World Congress on railway research. Various articles about the JU featured in the media in 2022 were popular and these have been monitored and archived as well as featured in the monthly JU newsletter and on social media. More in-depth articles and features have also been featured on the website's homepage slider.

ANNEX D: Patents from projects

Project Number	Project Acronym	Project Call Id	Number Of CR Patents
777576	ETALON	H2020-S2RJU-OC-2017	4

ANNEX E: Scoreboard of Horizon 2020 (H2020) legacy KPIs

TABLE I - Horizon 2020 Key Performance Indicators⁷⁵ common to all JUs

	Correspondence to general Annex 1	Key Performance Indicator	Definition/Responding to question	Type of data required	Data to be provided by	Baseline at the start of H2020 (latest available)	Target at the end of H2020	Automated	Result 2022
INDUSTRIAL LEADERSHIP	12*	SME - Share of participating SMEs introducing innovations new to the company or the market (covering the period of the project plus three years);	Based on Community Innovation Survey (?). Number and % of participating SMEs that have introduced innovations to the company or to the market	Number of SMEs that have introduced innovations;	H2020 beneficiaries through project reporting	N/A [new approach under H2020]	50%	Yes	192 (74%)
	13	SME - Growth and job creation in participating SMEs	Turnover of company, number of employees	Turnover of company, number of employees;	H2020 beneficiaries through project reporting	N/A [new approach under H2020]	To be developed based on FP7 ex-post evaluation and /or first H2020 project results	Yes	N/A
SOCIETAL CHALLENGES	14*	Publications in peer-reviewed high impact journals in the area of the JU	The percentage of papers published in the top 10% impact ranked journals by subject category	Publications from relevant funded projects (DOI: Digital Object Identifiers); Journal impact benchmark (ranking) data to be collected by commercially available bibliometric databases.	H2020 beneficiaries through project reporting; Responsible Directorate/Service (via access to appropriate bibliometric databases)	N/A [new approach under H2020]	[On average, 20 publications per €10 million funding (for all societal challenges)]	Yes	519

⁷⁵ Based on Annex II to Council Decision 2013/743/EU

Correspondence to general Annex 1	Key Performance Indicator	Definition/Responding to question	Type of data required	Data to be provided by	Baseline at the start of H2020 (latest available)	Target at the end of H2020	Automated	Result 2022
15*	Patent applications and patents awarded in the area of the JU	Number of patent applications by theme; Number of awarded patents by theme	Patent application number	H2020 beneficiaries through project reporting; Responsible Directorate/Service (via worldwide search engines such as ESPACENET, WOPI)	N/A [new approach under H2020]	On average, 2 per €10 million funding (2014 - 2020) RTD A6	Yes	4
16*	Number of prototypes testing activities and clinical trials	Number of prototypes, testing (feasibility/demo) activities, clinical trials	Reports on prototypes, and testing activities, clinical trials	H2020 beneficiaries through project reporting	N/A [new approach under H2020]	[To be developed on the basis of first Horizon 2020 results]	Yes	602
17*	Number of joint public-private publications in projects	Number and share of joint public-private publications out of all relevant publications	Properly flagged publications data (DOI) from relevant funded projects	H2020 beneficiaries through project reporting; Responsible Directorate/Service (via DOI and manual data input-flags)	N/A [new approach under H2020]	[To be developed on the basis of first Horizon 2020 results]	Yes	49
18*	New products, processes, and methods launched into the market	Number of projects with new innovative products, processes, instruments, methods, technologies	Project count and drop-down list allowing to choose the type processes, products, instruments, methods, technologies	H2020 beneficiaries through project reporting	N/A [new approach under H2020]	[To be developed on the basis of first Horizon 2020 results]	Yes	62

	Correspondence to general Annex 1	Key Performance Indicator	Definition/Responding to question	Type of data required	Data to be provided by	Baseline at the start of H2020 (latest available)	Target at the end of H2020	Automated	Result 2022
EVALUATION	N/A	Time to inform (average time in days) <u>all applicants</u> of the outcome of the evaluation of their application from the final date for submission of completed proposals	To provide applicants with high quality and timely evaluation results and feedback after each evaluation step by implementing and monitoring a high scientific level peer-reviewed process	Number of days (average)	Joint Undertaking	H2020		Yes	all calls (TTI): average 94 / Maximum 176 2022 calls: N/A**
	N/A	Time to inform (average time in days) <u>successful applicants</u> of the outcome of the evaluation of their application from the final date for submission of completed proposals		Number of days (average)	Joint Undertaking	H2020		Yes	all calls (TTI): average 94 / Maximum 176 2022 calls: N/A**
	N/A	Redress after evaluations	To provide applicants with high quality and timely evaluation results and feedback after each evaluation step by implementing and monitoring a high scientific level peer-reviewed process	Number of redresses requested	Joint Undertaking	H2020			N/A**
GRANTS	N/A	Time to grant (average) measured from call deadline to signature of grants	To minimise the duration of the granting process aiming at ensuring a prompt implementation of the Grant Agreements through a simple and transparent grant preparation process	Average in days under H2020 TTG < 270 days (as % of GAs signed)	Joint Undertaking	H2020		Yes	all calls (TTG): average 191 2022 calls: N/A**
	N/A	Time for signing grant agreements from the date of informing successful applicants (average values)		Average in days under H2020	Joint Undertaking	H2020		Yes	all calls (TTS): average 94 2022 calls: N/A**

	Correspondence to general Annex 1	Key Performance Indicator	Definition/Responding to question	Type of data required	Data to be provided by	Baseline at the start of H2020 (latest available)	Target at the end of H2020	Automated	Result 2022
AUDITS	N/A	Error rate		Representative error in %; residual error in %	CAS	H2020	The residual error rate should be within the threshold of 2%	No	representative error of 2,22% for the JU (weighted average); residual error of 1,27% for the JU (weighted average)
	N/A	Implementation of ex-post audit results		Number of cases implemented; in total €million; Number of cases implemented/total cases	Joint Undertaking	H2020		No	69 implemented cases, EUR 0,24 million 87% of total cases

	Correspondence to general Annex 1	Key Performance Indicator	Definition/Responding to question	Type of data required	Data to be provided by	Baseline at the start of H2020 (latest available)	Target at the end of H2020	Automated	Result 2022
PAYMENTS	N/A	Time to pay (% made on time) -pre-financing - interim payment -final payment	To optimize the payments circuits, both operational and administrative, including payments to experts	Average number of days for Grants pre-financing, interim payments and final payments; Average number of days for administrative payments; Number of experts appointed	Joint Undertaking	H2020	-pre-financing (30 days) - interim payment (90 days) -final payment (90days)	Yes	<u>Operational:</u> Pre-financing: 10 (100%) Average number of days: 10 Interim/final: 153 (88,3%) Average number of days: 36 <u>Administrative:</u> Pre-financing: 3 (100%) Average number of days: 8 Interim/final: 527 (95,1%) Average number of days: 16
HR	N/A	Vacancy rate (%)		post filled in %, composition of the JU staff ⁷⁶	Joint Undertaking	H2020			97%

⁷⁶ Additional indicators can be proposed/discussed with R.1 and/or DG HR

	Correspondence to general Annex 1	Key Performance Indicator	Definition/Responding to question	Type of data required	Data to be provided by	Baseline at the start of H2020 (latest available)	Target at the end of H2020	Automated	Result 2022
JU EFFICIENCY	N/A	Budget implementation/execution: 1. % CA to total budget 2. % PA to total budget	Realistic yearly budget proposal, possibility to monitor and report on its execution, both in commitment (CA) and payments (PA), in line with sound financial management principle	% of CA and PA	Joint Undertaking	H2020	100% in CA and 90% in PA	Yes	CA: 100% PA: 79,1%
	N/A	Administrative Budget: Number and % of total of late payments	Realistic yearly budget proposal, possibility to monitor and report on its execution in line with sound financial management principle	Number of delayed payments % of delayed payments (of the total)	Joint Undertaking		H2020	Yes	38 late payments 5%

NOTES:

12,14,15,16,17,18*: The upcoming Control Gates (April) and project Reviews could generate improved data for this KPI which is cumulative on the S2R running projects in 2022.

18*: This indicator is not a legally compulsory one, but it covers several additional specific indicators requested for more societal challenges by the services in charge.

** : In 2022, there were no new EU-Rail calls for proposals under H2020. Statistics related to the two 2022 EU-Rail calls pertaining to the Horizon Europe Programme are provided in Section 1.5 of this CAAR.

TABLE II - Indicators for monitoring H2020 Cross-Cutting Issues⁷⁷ common to all JTI JUs

Correspondence to the general Annex 2	Cross-cutting issue	Definition/Responding to question	Type of data required	Data to be provided by	Data to be provided in/to	Direct contribution to ERA	Automated	Result 2022
2	Widening the participation	2.1 Total number of participations by EU-28 Member State	Nationality of H2020 applicants & beneficiaries (number of countries)	H2020 applicants & beneficiaries at the submission and grant agreement signature stage	JU AAR RTD Monitoring Report	Yes	Yes	N/A**
		2.2 Total amount of EU financial contribution by EU-28 Member State (EUR millions)	Nationality of H2020 beneficiaries and corresponding EU financial contribution	H2020 beneficiaries at grant agreement signature stage	JU AAR RTD Monitoring Report	Yes	Yes	N/A**
N/A		Total number of participations by Associated Countries	Nationality of H2020 applicants & beneficiaries (number of countries)	H2020 applicants & beneficiaries at the submission and grant agreement signature stage	JU AAR RTD Monitoring Report	Yes	Yes	N/A**
N/A		Total amount of EU financial contribution by Associated Country (EUR millions)	Nationality of H2020 beneficiaries and corresponding EU financial contribution	H2020 beneficiaries at grant agreement signature stage	JU AAR RTD Monitoring Report	Yes	Yes	N/A**
3	SMEs participation	3.1 Share of EU financial contribution going to SMEs (Enabling & industrial tech and Part III of Horizon 2020)	Number of H2020 beneficiaries flagged as SME; % of EU contribution going to beneficiaries flagged as SME	H2020 beneficiaries at grant agreement signature stage	JU AAR RTD Monitoring Report		Yes	116 SME beneficiaries in total receiving 13,43% of the total contribution

⁷⁷ Based on Annex III to Council Decision 2013/743/EU

Correspondence to the general Annex 2	Cross-cutting issue	Definition/Responding to question	Type of data required	Data to be provided by	Data to be provided in/to	Direct contribution to ERA	Automated	Result 2022
6	Gender	6.1 Percentage of women participants in H2020 projects	Gender composition of participants in H2020 projects	H2020 Beneficiaries throughout project reporting		Yes	Yes	N/A**
		6.2 Percentage of women project coordinators in H2020	Gender of MSC fellows, ERC principle investigators and scientific coordinators in other H2020 activities	H2020 beneficiaries at the grant agreement signature stage		Yes	Yes	N/A**
		6.3 Percentage of women in EC advisory groups, expert groups, evaluation panels, individual experts, etc.	Gender composition of memberships in advisory groups, panels, etc.	Compiled by Responsible Directorate/ Service /Joint Undertaking based on existing administrative data made available by the CSC		Yes	No	EU-Rail Governing Board: 14,2% of representatives are female among the GB members, 9% among all members including alternates - JU States Representatives Group: 35% of representatives are female - JU Scientific Committee: 33% of members are female
7	International cooperation	7.1 Share of third-country participants in Horizon 2020	Nationality of H2020 beneficiaries	H2020 beneficiaries at the grant agreement signature stage	JU AAR RTD Monitoring Report	No	Yes	N/A**
		7.2 Percentage of EU financial contribution	Nationality of H2020 beneficiaries and	H2020 beneficiaries at the grant agreement signature stage	JU AAR RTD Monitoring Report	No	Yes	N/A**

Correspondence to the general Annex 2	Cross-cutting issue	Definition/Responding to question	Type of data required	Data to be provided by	Data to be provided in/to	Direct contribution to ERA	Automated	Result 2022
		attributed to third country participants	corresponding EU financial contribution					
9	Bridging from discovery to market ⁷⁸	9.1 Share of projects and EU financial contribution allocated to Innovation Actions (IAs)	Number of IA projects	Project Office – at GA signature stage he/she will be required to flag in SyGMa. Responsible Directorate/Service (WP coordinator)/Joint Undertaking - via tool CCM2	JU AAR RTD Monitoring Report		Yes	N/A**
		9.2 Within the innovation actions, share of EU financial contribution focused on demonstration and first-of-a-kind activities	Topics properly flagged in the WP; follow-up at grant level	Responsible Directorate/Service (WP coordinator)/Joint Undertaking - via tool CCM2	JU AAR RTD Monitoring Report		Yes	N/A%
N/A		10 Scale of impact of projects (High Technology Readiness Level)	Number of projects addressing TRL ⁷⁹ between 4-6 and 5-7	Joint Undertaking	JU AAR RTD Monitoring Report		No	TRL 4-6 (incl. projects up to TRL 4): 2 TRL 5-7: 0 Total: 2
11	Private sector	11.1 Percentage of H2020 beneficiaries from the private for-profit sector	Number of and % of the total H2020 beneficiaries classified by type of activity and legal status	H2020 beneficiaries at grant agreement signature stage	JU AAR RTD Monitoring Report		Yes	308 for-profit beneficiaries in total representing 66,52% of the total number beneficiaries

⁷⁸ The indicator 9.2 initially intended to monitor the Digital Agenda (its applicability could be limited)

⁷⁹ TRL: Technology Readiness Level

Correspondence to the general Annex 2	Cross-cutting issue	Definition/Responding to question	Type of data required	Data to be provided by	Data to be provided in/to	Direct contribution to ERA	Automated	Result 2022
		11.2 Share of EU financial contribution going to private for-profit entities (Enabling & industrial tech and Part III of Horizon 2020)	H2020 beneficiaries classified by type of activity; corresponding EU contribution	H2020 beneficiaries at grant agreement signature stage	JU AAR RTD Monitoring Report		Yes	70,73% of the total contribution
12	Funding for PPPs	12.1 EU financial contribution for PPP (Art 187)	EU contribution to PPP (Art 187)	Responsible Directorate/Service	JU AAR RTD Monitoring Report		Yes	S2R: EUR 44 ,6M EU-Rail: EUR 112,7M
		12.2 PPPs leverage: total amount of funds leveraged through Art. 187 initiatives, including additional activities, divided by the EU contribution	Total funding made by private actors involved in PPPs - in-kind contribution already committed by private members in project selected for funding - additional activities (i.e. research expenditures/investment of industry in the sector, compared to previous year)	Joint Undertaking Services	JU AAR RTD Monitoring Report			128% 147%
13	Communication and dissemination	13.3 Dissemination and outreach activities other than peer-reviewed publications - [Conferences, workshops, press releases, publications, flyers, exhibitions, trainings, social media, websites, communication campaigns (e.g. radio, TV)]	A drop-down list allows to choose the type of dissemination activity. Number of events, funding amount and number of persons reached thanks to the dissemination activities	H2020 Beneficiaries throughout project reporting	JU AAR RTD Monitoring Report	Yes	Yes	4.968 Dissemination and outreach activities other than peer-reviewed publications People reached: 1.236.597

Correspondence to the general Annex 2	Cross-cutting issue	Definition/Responding to question	Type of data required	Data to be provided by	Data to be provided in/to	Direct contribution to ERA	Automated	Result 2022
14	Participation patterns of independent experts	14.2 Proposal evaluators by country	Nationality of proposal evaluators	Responsible Directorate /Service/Joint Undertaking in charge with the management of proposal evaluation			Yes	N/A**
		14.3 Proposal evaluators by organisations' type of activity	Type of activity o' evaluators' organisations	Responsible Directorate /Service/Joint Undertaking in charge with the management of proposal evaluation			Yes	N/A**
N/A	Participation of RTOs and Universities	Participation of RTOs ⁸⁰ and Universities in PPPs (Art 187 initiatives)	Number of participations of RTOs to funded projects and % of the total Number of participations of Universities to funded projects and % of the total % of budget allocated to RTOs and to Universities	H2020 beneficiaries at the grant agreement signature stage	JU AAR RTD Monitoring Report	Yes	Yes	N/A**

⁸⁰ RTO: Research and Technology Organisation

Correspondence to the general Annex 2	Cross-cutting issue	Definition/Responding to question	Type of data required	Data to be provided by	Data to be provided in/to	Direct contribution to ERA	Automated	Result 2022
N/A	Ethics	The objective is ensuring that research projects funded are compliant with provisions on ethics	% of proposals not granted because non-compliance with ethical rules/proposals invited do grant (target 0%); time to ethics clearance (target 45 days) ⁸¹	Responsible Directorate /Service/Joint Undertaking	JU AAR RTD Monitoring Report			N/A**

NOTES:

*H2020–applicants - all those who submitted H2020 proposals

*H2020 beneficiaries - all those who have signed a H2020 Grant Agreement

** : In 2022, there were no new EU-Rail calls for proposals under H2020. Statistics related to the two 2022 EU-Rail calls pertaining to the Horizon Europe Programme are provided in Section 1.5 of this CAAR.

⁸¹ Data relates to pre-granting ethics review. This time span runs in parallel to granting process.

TABLE III - Key Performance Indicators specific for EU-Rail

#	Key Performance Indicator	Objective	Data to be provided by	Baseline at the start of H2020	Target at the end of H2020	Automated	Result 2022
EU-Rail							
1	% reduction in the costs of developing, maintaining, operating and renewing infrastructure and rolling stock and increase in energy efficiency compared to "Stat"-of-the-art	Reduce the life-cycle cost of the railway transport system	JU	"State-of-the-art" 2014	> 50 %	No	See Table IV
2	% increase the capacity of railway segments to meet increased demand for passenger and freight railway services compared to "Stat"-of-the-art 2014	Enhance the capacity of the railway transport system	JU	"State-of-the-art" 2014	100%	No	See Table IV
3	% decrease in unreliability and late arrivals compared to "State-of-the-art" 2014	Increase in the quality of rail services	JU	"State-of-the-art" 2014	> 50%	No	See Table IV
4	Reduce noise emissions and vibrations linked to rolling stock and respectively infrastructure compared to "State-of-the-art" 2014	Reduce the negative externalities linked to railway transport	JU	"State-of-the-art" 2014	> 3 - 10 dBA	No	TD1.5 Brake system activities concluded that a reduction of brake noise and dust emissions between 5 and 15% can be expected. The first preliminary investigation showed that, in some conditions, the noise level could be reduced up to 5 dB.
5	Addressing open points in TSIs, compared to "State-of-the-art" 2014	Enhance interoperability of the railway system	JU	"State-of-the-art" 2014		No	- One open point of the TSI Infra (tender and IN2TRACK-2) and open point TSI ENE (tender pantograph overhead contact line) - ATO over ETCS up to GoA3/4 (X2RAIL-4 TD2.2 D.3.1

#	Key Performance Indicator	Objective	Data to be provided by	Baseline at the start of H2020	Target at the end of H2020	Automated	Result 2022
							https://projects.shift2rail.org/s2r_ip2_n.aspx?p=X2RAIL-4 - Contribution to FRMCS Readiness (no direct TD reference, Activity financed via operational procurement "Support to the ERTMS Deployment action as baseline for Shift2Rail (IP2) innovative solutions") - ITD in IP2 (a) Integrated Technology Demonstrator gathering S2R TD2.1 (Adaptable Communication System), S2R TD2.3 (Moving Block), S2R TD2.5 (Train Integrity); b) Related projects: X2RAIL-5; c) Deliverable: D12.1 (to be released in May 2023) – deliverable will be public)
6	Number of Integrated Technology Demonstrators (ITDs) and System Platform Demonstrations (SPD)	Improve market uptake of innovative railway solutions through large-scale demonstration activities	JU	Multi-Annual Action Plan	4 SPD	No	- X2R5 D12.1 - IP2 ITD (TD2.1, TD2.3, TD2.5) - IP4 ITD4.7 Cohesive final release - IP3 - IN2STEMPO – D10.2 (TD3.9/3.10)
7	Share of the fund allocated to the different Innovation Programmes and to cross-cutting themes	Ensure that funding covers the railway system as a whole	JU	N/A	> 80%	No	100% of the operational funding
8	Percentage of topics resulting in signature of GA	Ensure a sufficiently high call topics success rate	JU	N/A	> 90%	Yes	N/A*
9	% of resources consumption versus plan (members only)	WP execution–by members - resources	JU	N/A	> 80%	Yes	-

#	Key Performance Indicator	Objective	Data to be provided by	Baseline at the start of H2020	Target at the end of H2020	Automated	Result 2022
10	% of deliverables available versus plan (members only)	WP execution—by members - deliverables	JU	N/A	> 80%	No	91,8% - 2015-2020 71,3% - 2020 72,7% - 2021 57% - 2022**

NOTES:

*: In 2022, there were no new EU-Rail calls for proposals under H2020. Statistics related to the two 2022 EU-Rail calls pertaining to the Horizon Europe Programme are provided in Section 1.5 of this CAAR.

** : The KPI value is affected by the fact that several amendments to the Grant Agreements proposed by the members were in the process of approval by the cut-off date, and consequently, until the amendments are approved, the concerned deliverables are formally considered delayed.

TABLE IV – Initial Estimation – Release 5 - of the Key Performance Indicators of the Shift2Rail Programme

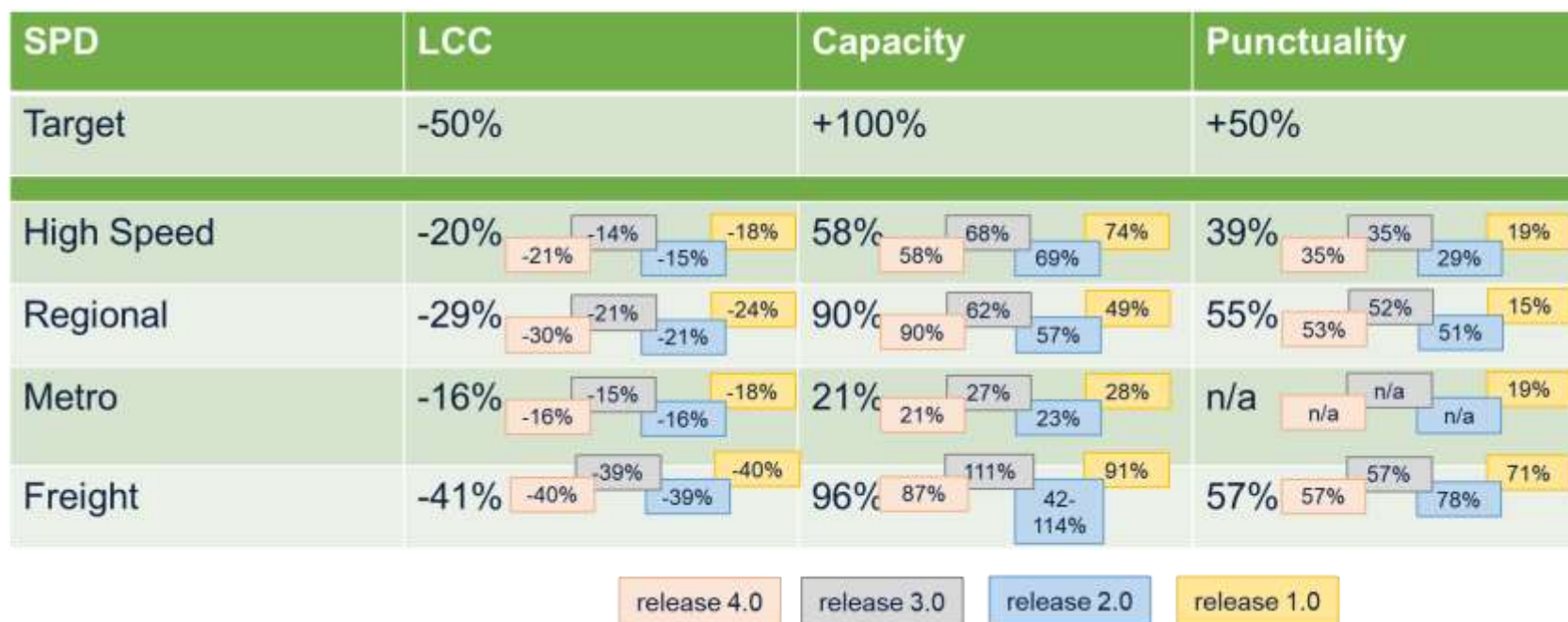

One of the objectives of the Shift2Rail Joint Undertaking defined in its regulation is to seek developing, integrating, demonstrating and validating innovative technologies and solutions that uphold the strictest safety standards and the value of which can be measured against, inter alia, 3 quantitative Key Performance Indicators (KPIs). The targets defined are the following: reduction of LCC by 50%, improving the reliability & punctuality by 50% and doubling the capacity.

As the railway is a very interlinked and complex system, it is required to have specific tools and methods to evaluate the effect of technological developments. This question is highly relevant for Shift2Rail as the technologies, which are developed, are to be evaluated with respect to four scenarios called System Platform Demonstrators (SPDs). Hence an approach of estimating the above mentioned KPIs applied on the four generic SPDs based on the market segments high-speed rail, regional rail, metro and freight rail⁸² has been applied which were defined in the S2R Master Plan⁸³.

⁸² IMPACT-1 – D4.1 “Reference Scenario” – 2018, Issue 1

⁸³ Shift2Rail - Shift2Rail Master Plan (MP) – 2015

As some of the Shift2Rail technologies (e.g. Innovation Programme on IT Solutions for Attractive Railway Services) are targeting to increase modal share of rail within the transport sectors by satisfying the customer's travel experience, those innovations cannot be taken directly into account in the three quantitative KPIs, only via an increased load factor. Therefore, a dedicated model on the improvement of the attractiveness of the rail system is developed independent from the model discussed here (see also explanations to "demand effect").

In 2022, the Release 5 of the KPI model was published. After Release 4, the model was frozen and in 2022, the collection of updated improvement values and accuracy levels was carried out.

The Accuracy of the improvement data was developed for Release 3 to increase the robustness of the model. In Release 4 and 5, the reported numbers of data set linked to the accuracy level and the values of the accuracy level increased.

Key Performance Indicators – KPI

The KPI Life-Cycle-Cost (LCC) is defined as the cost for the railway undertaking over the lifespan of the systems. Hence, they are the investment cost, operative cost like maintenance, labour or energy cost and, where applicable, the dismantling cost.

The KPI Capacity is defined as the maximum possible capacity, which is the maximum number of transportable passengers in one peak hour for the passenger transport scenarios and the maximum of tonne-kilometres in 24 hours for freight.

The KPI Reliability and Punctuality is measured as a 50% decrease of late arrivals mainly caused by unreliability of technologies.

System Platform Demonstrators – SPDs

The reference scenarios (state of the art technologies in 2013) described in the deliverable D4.1 "Reference Scenarios" of IMPACT-1 and were further developed in IMPACT-2. The data for these scenarios were collected from various sources whereas usually there could only one source for each certain parameter be found. The coherence check is scheduled for the next iteration of the model.

Further there are aspects for the four different market segments of the SPDs, which need to be kept in mind, when reviewing the result table. Those aspects are due to the inherent structure and specificities of the different market segments:

For the High-Speed passenger transport (SPD1), relatively new or constantly upgraded vehicles and lines are taken into account, which are more or less best of class in Europe. Therefore, it is on the one hand a much-elaborated basis to start from and on the other hand it can be assumed that effects at less developed railways will show much higher results.

The main relevant KPIs for typically Regional Rail (SPD2) lines are LCC and punctuality. Hence the challenge is here to provide a punctual service at lower cost.

Concerning Metro Rail (SPD3), there are few activities dedicated directly on Metro in direct relation to the specific S2R JU objectives in the short term. Therefore, the results for Metro are mainly based on positive effects of the innovations developed for High Speed or Regional trains as e.g. reduction of energy consumption or improved maintenance. They are not optimised for this special form of rail transport but can help to reduce LCC and improve capacity.

Because SPD4, Freight rail, is not focussing on passenger transport, but freight transport, it differs in some definitions and focus points from the other three SPDs. Further the modelling has not only to consider technological improvements, but also operational optimisation for rail freight transport. Moreover, as generally the introduction of innovations in freight rail operation takes more time than in passenger transport, the technology level in execution is quite moderate. Taking both into account, the more legacy basis to start from and the technological and operational effects, the achievable benefits are much higher than for the other three SPDs.

Furthermore, some innovations cannot show their full potential, because there is only one scenario per market segment. Those scenarios are optimised to show the majority of positive effects but cannot be set to show every effect of every Shift2Rail innovation.

Demand effect

As already explained in the background, large parts of positive effects especially for the passenger transport (SPD1-3) are not adequately measurable through LCC, capacity and punctuality, e.g. new IT solutions (IP4), effects of other innovations such as noise mitigation, customer-oriented services and better quality, increased comfort for the customers, better governance etc. Those will be included in the attractiveness model. Therefore, the increase of demand is not considered in the results for the passenger SPDs, yet, meaning that for the first results there is no change in the load factor and therefore in the demand included. For the freight SPD, a demand increase could already be considered and therefore also its positive effect on the contribution margin.

ANNEX F: HORIZON EUROPE KPIs

Scoreboard of Horizon Europe common Key Impact Pathway Indicators (KIPs)*

Key Impact Pathway**	Short-term	Medium-term	Longer-term	Detail per action or globally for 2022
Towards scientific impact				
1-Creating high-quality new knowledge	Publications - Number of peer-reviewed scientific publications resulting from the Programme	Citations - Field-Weighted Citation Index of peer-reviewed Publications resulting from the Programme	World-class science - Number and share of peer-reviewed publications resulting from the projects funded by the Programme that are core contribution to scientific fields	No data available for 2022
2-Strengthening human capital in R&I	Skills - Number of researchers involved in upskilling (training, mentoring/coaching, mobility and access to R&I infrastructures) activities in projects funded by the Programme	Careers - Number and share of upskilled researchers involved in the Programme with increased individual impact in their R&I field	Working conditions - Number and share of upskilled researchers involved in the Programme with improved working conditions, including researchers' salaries	No data available for 2022
3-Fostering diffusion of knowledge and open science	Shared knowledge Share of research outputs (open data/publication/software etc.) resulting from the Programme shared through open knowledge infrastructures	Knowledge diffusion - Share of open access research outputs resulting from the Programme actively used/cited	New collaborations - Share of Programme beneficiaries which have developed new transdisciplinary/trans sectoral collaborations with users of their open access research outputs resulting from the Programme	No data available for 2022
Towards societal impact				
4-Addressing Union policy priorities and global challenges through R&I	Results - Number and share of results aimed at addressing identified Union policy priorities and global challenges (including SDGs) (multidimensional: for each identified priority) Including: Number and share of climate-relevant results aimed at delivering on the Union's commitment under the Paris Agreement	Solutions - Number and share of innovations and research outcomes addressing identified Union policy priorities and global challenges (including SDGs) (multidimensional: for each identified priority) Including: Number and share of climate-relevant innovations and research outcomes delivering on	Benefits - Aggregated estimated effects from use/exploitation of results funded by the Programme on tackling identified Union policy priorities and global challenges (including SDGs), including contribution to the policy and law-making cycle (such as norms and standards) (multidimensional: for each identified priority) Including: Aggregated estimated effects from use/exploitation of climate-relevant results funded by the Programme on delivering on the Union's commitment under the Paris Agreement including	No data available for 2022

		Union's commitment under the Paris Agreement	contribution to the policy and law-making cycle (such as norms and standards)	
5-Delivering benefits and impact through R&I missions	R&I mission results - Results in specific R&I missions (multidimensional: for each identified mission)	R&I mission outcomes - Outcomes in specific R&I missions (multidimensional: for each identified mission)	R&I mission targets met -Targets achieved in specific R&I missions (multidimensional: for each identified mission)	No data available for 2022
6-Strengthening the uptake of R&I in society	Co-creation - Number and share of projects funded by the Programme where Union citizens and end-users contribute to the co-creation of R&I content	Engagement - Number and share of participating legal entities which have citizen and end-users engagement mechanisms in place after the end of projects funded by the Programme	Societal R&I uptake - Uptake and outreach of co-created scientific results and innovative solutions generated under the Programme	No data available for 2022
Towards technological / economic impact				
7-Generating innovation-based growth	Innovative results - Number of innovative products, processes or methods resulting from the Programme (by type of innovation) & Intellectual Property Rights (IPR) applications	Innovations - Number of innovations resulting from the projects funded by the Programme (by type of innovation) including from awarded IPRs	Economic growth - Creation, growth & market shares of companies having developed innovations in the Programme	No data available for 2022
8-Creating more and better jobs	Supported employment - Number of full time equivalent (FTE) jobs created, and jobs maintained in participating legal entities for the project funded by the Programme (by type of job)	Sustained employment - Increase of FTE jobs in participating legal entities following the project funded by the Programme (by type of job)	Total employment - Number of direct & indirect jobs created or maintained due to diffusion of results from the Programme (by type of job)	No data available for 2022
9-Leveraging investments in R&I	Co-investment - Amount of public & private investment mobilised with the initial investment from the Programme	Scaling-up - Amount of public & private investment mobilised to exploit or scale-up results from the Programme (including foreign direct investments)	Contribution to '3 % target' - Union progress towards 3 % GDP target due to the Programme	No data available for 2022

* (based on Annex V to Regulation 2021/695/EU)

** NB: For some of those KIPs the data will not be available in the short or even medium term.

Horizon Europe Partnership common Indicators

Criterion addressed	Name of the Indicator	Baseline at the start of HE	Results for 2022	Target 2027
Additionality	Progress towards (financial and in-kind) contributions from partners other than the Union – i.e. committed vs. actual	N/A	No data available for 2022	Total In kind contribution: EUR 576 million Total financial contribution to the JU running costs: EUR 24 million
Additionality / Synergies	Additional investments triggered by the EU contribution, including qualitative impacts related to additional activities	N/A	Over the course of the programme, EU-Rail members contribute with additional activities, including mobilisation of private investment and national/regional programmes. Expected according to IKAA Plan 2022- 2024: 2022 = EUR 28,1 million Estimated 2022 value of IKAA linked to JU objectives/KPIs - EUR 4,8 million Estimated 2022 value of IKAA link to JU project/topics - EUR 23,8 million	Target 2022-2024: EUR 150,5 million

Directionality	Overall (public and private, in-kind and cash) investments mobilised towards EU priorities	0	<p>EUR 232,5 million linked both to:</p> <ul style="list-style-type: none"> - European Green Deal - Europe fit for digital age 	EUR 600 million
International visibility and positioning	International actors involved	0	<p>12 entities from Associated countries and Third countries are participating in projects as associated partners (8 from Norway and 4 from Switzerland)</p> <p>By type: 1 public organizations (8%), 2 higher or secondary education establishment (17%), 4 research organizations (33%) and 5 private for profit organizations (42%)</p>	N/A
Transparency and openness	Share & type of stakeholders and countries invited/engaged	0	<p>In general the entire rail value chain.</p> <p>In projects:</p> <p>203 beneficiaries (6 public organizations (3%), 17 higher or secondary education establishment (8%), 26 research organizations (13%), 147 private for profit organizations (73%) and 7 others(3%))</p> <p>from:</p> <p>14 countries (12 from EU and 2 associated countries)</p> <p>In the EU-Rail State Representatives Group:</p> <p>25 member states demonstrating interest (21 from EU and 4 associated countries)</p>	N/A

Transparency and openness	No and types of newcomer members in partnerships and their countries of origin (geographical coverage)	0	Organisation Name	Category	Country
			Administrador de Infraest	[PRV Other Industrial and/or profit Private organisation]	ES
Alstom Transport SA	[PRV Other Industrial and/or profit Private organisation]	FR			
ANGELRAIL consortium le	[PRV Other Industrial and/or profit Private organisation]	IT			
AŽD Praha s.r.o	[PRV Other Industrial and/or profit Private organisation]	CZ			
Construcciones y Auxiliari	[PRV Other Industrial and/or profit Private organisation]	ES			
Asociación Centro Tecnol	[RES Public research organisation (including international research organisation as well as private research organisation controlled by a public authority)]	ES			
České dráhy, a.s.	[PRV Other Industrial and/or profit Private organisation]	CZ			
Deutsche Bahn AG	[PRV Other Industrial and/or profit Private organisation]	DE			
Deutsches Zentrum für Lu	[RES Public research organisation (including international research organisation as well as private research organisation controlled by a public authority)]	DE			
European Smart Green Ra	[PRV Other Industrial and/or profit Private organisation] + [RES Public research organisation (including international research organisation as well as private research organisation controlled by a public authority)]	ES N/A			
Faiveley Transport SAS	[PRV Other Industrial and/or profit Private organisation]	FR			
Ferrovie dello Stato Italian	[PRV Other Industrial and/or profit Private organisation]	IT			
Hitachi Rail STS S.p.A.	[PRV Other Industrial and/or profit Private organisation]	IT			
INDRA SISTEMAS S.A & PATE	[PRV Other Industrial and/or profit Private organisation]	ES			
Jernbanedirektorate (Norv	[PRV Other Industrial and/or profit Private organisation]	NO			
Knorr-Bremse Systems für	[PRV Other Industrial and/or profit Private organisation]	DE			
Österreichische Bundesba	[PRV Other Industrial and/or profit Private organisation]	AT			
Polskie Koleje Państwowe	[PRV Other Industrial and/or profit Private organisation]	PL			
ProRail B.V. & NS Groep N.V.	[PRV Other Industrial and/or profit Private organisation]	NL			
Siemens Mobility GmbH	[PRV Other Industrial and/or profit Private organisation]	DE			
Société nationale SNCF, sc	[PRV Other Industrial and/or profit Private organisation]	FR			
Strukton Rail Nederland B	[PRV Other Industrial and/or profit Private organisation]	NL			
THALES SIX GTS France SA	[PRV Other Industrial and/or profit Private organisation]	FR			
Trafikverket	[PRV Other Industrial and/or profit Private organisation]	SE			
voestalpine Railway Syste	[PRV Other Industrial and/or profit Private organisation]	AT			

<p>Transparency and openness</p>	<p>No and types of newcomer beneficiaries in funded projects (in terms of types and countries of origin)</p>	<p>N/A</p>	<p>99 newcomers (90 EU & 9 Non-EU) of which 22 are SMEs.</p> <p>PRC: 74 PUB: 2 REC: 12 OTH: 3 HES: 8</p>	
<p>Coherence and synergies</p>	<p>Number and type of coordinated and joint activities with other European Partnerships</p>	<p>0</p>	<p>4 back office arrangements (2 of them as leading and lead backup contracting authorising)</p>	<p>7 arrangements among JUs in accordance with Art. 13 of the SBA</p>
<p>Coherence and synergies</p>	<p>Number and type of coordinated and joint activities with other R&I Initiatives at EU /national/regional/sectorial level</p>	<p>0</p>	<p>Coordinated activities at EU level with national / sectorial R&I actions on the Digital Automated Couplers with the European DAC delivery Programme, enabled by EU-Rail.</p> <p>Rail system architecture coordinated in the System Pillar with national and sectorial input notably around signalling activities.</p> <p>Coordination also with Rail Net Europe on infrastructure capacity planning and R&I on traffic management.</p>	<p>N/A</p>

<p>Coherence and synergies</p>	<p>Complementary and cumulative funding from other Union funds (Horizon Europe, National funding, ERDF, RRF, Other cohesion policy funds, CEF, DEP, LIFE, other)</p>	<p>0</p>	<p>Synergies with EU Missions - EUR 0,7 million for Smart Cities</p> <p>Following the signature in 2022 of a Contribution Agreement between the European Union, represented by the European Commission, and EU-Rail, with the objective to provide a financial contribution to finance the implementation of the action “Pilot project - IRS Smart Cities project: new railway station concept for green and socially inclusive smart cities”. In accordance with SBA Article 10.6, this additional contributions from Union programmes corresponding to additional tasks entrusted to EU-Rail shall not be accounted for in the calculation of the Union maximum financial contribution to the EU-Rail Programme.</p>	<p>N/A</p>
<p>International visibility and positioning</p>	<p>Visibility of the partnership in national, European, international policy/industry cycles</p>	<p>0</p>	<ul style="list-style-type: none"> • Published 10 newsletters • Published 7 press releases • Released 3 publications • Organised 4 events • Participated in 37 industry events • Average number of tweets per month was 33 • 4.701 twitter followers by the end of 2022 • 8.996 LinkedIn followers by the end of 2022 • 1.857 newsletter subscribers by the end of 2022 • 125 members in the general contact list (receiving the newsletter and mailshots) • 158 members in media list • 160 mentions in press articles 	<p>N/A</p>

Scoreboard of KPIs specific to EU-Rail

#	Impact areas	Key Performance Indicator	Objective	Baseline at the start of HE	Results of 2022	Target at the end of HE
1	Customer requirements	Accuracy in total planned travel time of passengers from improved matching between supply and demand, #	Increase availability and predictability of intermodal rail transport offer	State of art in 2020 (including results from S2R)	No data available	75%
		Traffic planning certainty, #	Planning certainty, considering the demand forecast, is a key requirement for planning on time, reliable and efficient service delivery	State of art in 2020 (including results from S2R)	No data available	Between 65% and 80% ¹
		Handling/response time for intermodal freight offers and regional passenger services, mins	Improve overall customer experience, including growing intermodal freight transport and regional passenger services	State of art in 2020 (including results from S2R)	No data available	-50%
2	Improved Capacity	Trains on the line per hour and direction, #	Increased frequency is a key element for improved capacity	State of art in 2020 (including results from S2R)	No data available	At least +10% ²
		Reduction of total freight transport time, mins	Reduced freight transport time leading to better asset utilization and increased capacity	State of art in 2020 (including results from S2R)	No data available	-33%
		Increased average freight train length in existing infrastructure limitations or higher loads, meters	Increased length directly leads to more available capacity	State of art in 2020 (including results from S2R)	No data available	Up to 1.500m
3	Reduced Costs	Overall OPEX and CAPEX costs of regional lines, incl. maintenance, infrastructure and vehicles	Direct link to lower costs of the regional lines	State of art in 2020 (including results from S2R)	No data available	tbc ³
		Maintenance costs, including thanks to the use of digital twins, €	Direct link to lower costs	State of art in 2020 (including results from S2R)	No data available	-10% ⁴

		Design and manufacturing costs, €	Leading to reduced investment cost	State of art in 2020 (including results from S2R)	No data available	-20%
		Virtual certification tasks that can be conducted in a laboratory, #	Cost of virtual certification activities is much lower than cost of physical certification activities, hence more tasks done virtually leads to lower costs	State of art in 2020 (including results from S2R)	No data available	+80% ⁵
4	Sustainable and resilient transport	Optimized energy consumption and higher punctuality in regional services, kWh per pax-km or tons-km; mins	More efficient operations, leading to lower energy consumption (with lower CO2 emissions)	State of art in 2020 (including results from S2R)	No data available	-10% (energy); +15% (punctuality)
		CO2 equivalent emissions	Further decrease rail carbon intensity	State of art in 2020 (including results from S2R)	No data available	Up to 30% for specific use cases (e.g. regional operation and heavy duty inspection vehicles)
		Traffic prediction performance, secs	Improve network resilience through dynamic infrastructure restriction handling, train regulation and automated conflict resolution	State of art in 2020 (including results from S2R)	No data available	<120 secs ⁶
		Time to respond and resolve a vulnerability (regarding cyber security), mins	Reduced impact of events and increased availability of the rail system	State of art in 2020 (including results from S2R)	No data available	tbc ⁷
5	Harmonized approach	CCS system CAPEX and OPEX (of main line and regional lines systems (while maintaining or increasing the present safety level	Reducing costs associated with the interoperability of the network will enhance harmonization	State of art in 2020 (including results from S2R)	No data available	CAPEX: -25% (regional lines) and -10% (main lines); OPEX -20% (regional and main lines)

		No new national technical rules triggered by innovative solutions coming from the Joint Undertaking and potential reduction of national rules in relation to ERTMS and interlocking	By decreasing the amount of national rules in force, rail transport will evolve towards the Single European Railway Area	State of art in 2020 (including results from S2R)	No data available	N/A
		Reduction of answering time between the short-term request of a cross-border train path and the answer with a firm offer, mins	Indicator for more efficient border crossing	State of art in 2020 (including results from S2R)	No data available	Down to 5 mins
		Operational dwell time at borders and other handover points relying also on relying on more homogenous system approaches (leading to increase number of trains on given infrastructure), mins	Indicator for more efficient border crossing	State of art in 2020 (including results from S2R)	No data available	-50%
6	Reinforced role for rail	Accuracy in total planned travel time of passengers from improved matching between supply and demand, %	The combination of the indicators from Impact Areas 1 and 3 contribute to more effective and cost-efficient rail transport, thereby improving attractiveness of rail compared with other transport modes	State of art in 2020 (including results from S2R)	No data available	75%
		Traffic planning certainty, #		State of art in 2020 (including results from S2R)	No data available	Between 65% and 80% ¹
		Handling/response time for intermodal freight offers and regional passenger services, mins		State of art in 2020 (including results from S2R)	No data available	-50%
		Overall OPEX and CAPEX costs of regional lines, incl. maintenance, infrastructure and vehicles		State of art in 2020 (including results from S2R)	No data available	tbc ³
		Maintenance costs, including thanks to the use of digital twins, €		State of art in 2020 (including results from S2R)	No data available	-10% ⁴
		Design and manufacturing costs, €		State of art in 2020 (including results from S2R)	No data available	-20%
		Virtual certification tasks that can be conducted in a laboratory, #		State of art in 2020 (including results from S2R)	No data available	+80% ⁵

7	Improved	Maturity of innovative technologies	Innovative technologies will deploy rail capabilities and leverage potential competitive advantages for the EU rail industry	State of art in 2020 (including results from S2R)	No data available	TRL 8
---	----------	-------------------------------------	--	---	-------------------	-------

¹ Depending on point in time, e.g. one week in advance or one hour in advance

² At the moment this KPIs is limited with the outcome of FA2 only, in the course of the Programme a consolidated KPI will be measured

³ The nature of the activity requires a full system approach analysis from improvement at components level, which will be conducted during the course of the Programme

⁴ In specific use cases for both rolling stock and infrastructure and asset management

⁵ Costs only related to the execution of the on-site tests

⁶ In a typical scenario of at least 100 trains running in a 2h interval ahead of actual time

⁷ Due to the confidentiality nature of the baseline, a KPI measure will be assessed and consolidated during the course of the Programme

⁸ As reflected in the ERA database(s) in relation to OPE TSI Appendix A, annex C and other TSIs in relation to ERTMS and interlocking

ANNEX G: IKAA REPORT

OVERVIEW AMOUNT OF IKAA FOR 2022						
AA type	Brief description of the AA	Link to JU objectives / KPIs (IKAA at Programme level)	Link to JU project/ topic (IKAA at project level; reference /name of the project)	Estimated total IK linked to this AA (if on several years)	Certified IKAA (€)	Reported IKAA with pending certification (€)
	1. Support to additional R&I					
	2. Scale up of technologies					
	3. Demonstrators					
	4. Creating new business opportunities					
	5. Training & skills development					
	6. Contribution to the development of new standards, regulations and policies					
	7. Supporting ecosystem development					
	8. Communication, dissemination, awareness raising, citizen engagement					
	9. Others					
TOTAL						
TOTAL IKAA						

TOTAL IKAA 2022: BREAKDOWN PER COUNTRY	
Country (code)	Value (€)

TOTAL IKAA 2021- 2022 (Evolution - Value in €)		
Planned IKAA	Reported IKAA with pending certification	Certified IKAA

ANNEX H: FINAL ANNUAL ACCOUNTS

Balance Sheet

	Note	31.12.2022	31.12.2021
<i>EUR '000</i>			
NON-CURRENT ASSETS			
<i>Intangible assets</i>		1	1
<i>Property, plant and equipment</i>	2.1	119	152
<i>Pre-financing</i>	2.2	104 485	9 167
		104 604	9 320
CURRENT ASSETS			
<i>Pre-financing</i>	2.2	18 392	67 410
<i>Exchange receivables and non-exchange recoverables</i>	2.3	63 358	40 277
		81 750	107 687
TOTAL ASSETS		186 354	117 006
CURRENT LIABILITIES			
<i>Payables and other liabilities</i>	2.4	85 123	97 906
<i>Accrued charges and deferred income</i>	2.5	53 031	57 488
		138 154	155 394
TOTAL LIABILITIES		138 154	155 394
<i>Contribution from Members</i>	2.6	761 096	528 779
<i>Accumulated deficit</i>		(567 167)	(433 698)
<i>Economic result of the year</i>		(145 729)	(133 469)
NET ASSETS		48 200	(38 388)
NET ASSETS AND LIABILITIES		186 354	117 006

Statement of financial performance

		EUR '000	
	Note	2022	2021
REVENUE			
Revenue from non-exchange transactions	3.1		
<i>Recovery of expenses</i>		142	119
		142	119
Revenue from exchange transactions	3.2		
<i>Other</i>		3	16
		3	16
Total revenue		145	135
EXPENSES			
<i>Operational costs</i>	3.3	(141 317)	(130 157)
<i>Staff costs</i>	3.4	(2 097)	(1 840)
<i>Other expenses</i>	3.5	(2 460)	(1 606)
Total expenses		(145 874)	(133 604)
ECONOMIC RESULT OF THE YEAR		(145 729)	(133 469)

Cash flow statement

	EUR '000	
	2022	2021
<i>Economic result of the year</i>	(145 729)	(133 469)
Operating activities		
<i>Depreciation and amortization</i>	57	55
<i>(Increase)/decrease in pre-financing</i>	(46 300)	19 743
<i>(Increase)/decrease in exchange receivables and non-exchange recoverables</i>	(23 081)	321
<i>Increase/(decrease) in payables</i>	(12 783)	441
<i>Increase/(decrease) in accrued charges & deferred income</i>	(4 457)	13 074
<i>Increase/(decrease) in cash contributions</i>	158 269	42 686
<i>Increase/(decrease) in in-kind contributions</i>	74 047	57 171
<i>Other non-cash movements</i>	-	-
Investing activities		
<i>(Increase)/decrease in intangible assets and property, plant and equipment</i>	(23)	(23)
NET CASHFLOW	-	-
<i>Net increase/(decrease) in cash and cash equivalents</i>	-	-
<i>Cash and cash equivalents at the beginning of the year</i>	-	-
<i>Cash and cash equivalents at year-end</i>	-	-

Statement of changes in net assets

EUR '000

	Contribution from Members	Accumulated Surplus/ (Deficit)	Economic result of the year	Net Assets
BALANCE AS AT 31.12.2020	428 922	(311 031)	(122 667)	(4 776)
<i>Allocation 2020 economic result</i>	-	(122 667)	122 667	-
<i>Cash contribution</i>	42 686	-	-	42 686
<i>Contribution in-kind</i>	57 171	-	-	57 171
<i>Economic result of the year</i>	-	-	(133 469)	(133 469)
BALANCE AS AT 31.12.2021	528 779	(433 698)	(133 469)	(38 388)
<i>Allocation 2021 economic result</i>	-	(133 469)	133 469	-
<i>Cash contribution</i>	155 272	-	-	155 272
<i>Contribution in-kind</i>	74 047	-	-	74 047
<i>Unpaid cash contributions</i>	2 997	-	-	2 997
<i>Economic result of the year</i>	-	-	(145 729)	(145 729)
BALANCE AS AT 31.12.2022	761 096	(567 167)	(145 729)	48 200

ANNEX I: MATERIALITY CRITERIA

This Annex provides explanation on how the EU-Rail Executive Director defined the materiality threshold as a basis for determining whether significant weaknesses should be subject to a formal reservation to his declaration of assurance. Both qualitative and quantitative criteria were set in this regard, as follows.

Qualitative criteria

Significant weaknesses in the internal control system

Deficiencies in EU-Rail's internal control system (ICS) considered significant, meaning that the existence of such deficiencies does not allow to conclude that the concerned ICS Component(s) and/or the ICS as a whole is present and functioning. ICS weaknesses may be identified by the JU's management activities, through dedicated self-assessment exercises, by internal or external auditors or by a third party, as applicable.

Critical issues outlined by the European Court of Auditors, the Internal Audit Service and OLAF

Any findings/observations made by the ECA, the IAS or OLAF, which, given their nature and/or magnitude, indicate serious deficiencies in management of risks or in the design and implementation of the internal control system at EU-Rail. Significant delay in the implementation of the action plan addressing previously issued critical findings/observations of ECA/IAS/OLAF may also be taken into account.

Significant reputational events

Events or weaknesses which have a significant reputational impact on EU-Rail, on the associated Commission services (DG MOVE, DG RTD), or on the European Union as such, irrespective of the amount of damage to EU-Rail's administrative and operational budget, will be considered for issuing a reservation to the declaration of assurance.

Quantitative criteria applicable to the JU's Programme falling under Horizon 2020 (S2R Programme)

Residual error rate

Given the fact that more than 90% of the JU's operational expenditure allocated to the H2020 Programme was related to its grants, the focus of assurance in terms of the legality and regularity of the underlying transactions will therefore principally be on the level of errors identified in the ex-post audits of cost claims in grants on a multi-annual basis. These ex-post audits are carried out by the CAS based on a common audit approach shared among the research framework' programmes' implementing bodies.

As a result of its multiannual nature, the effectiveness of the EU-Rail's controls can only be fully measured and assessed at the final stages of the Programme's lifetime once the ex-post audit strategy has been fully implemented and systematic errors have been detected and corrected.

In this respect, the decision on whether the ED needs to make a formal reservation to his declaration of assurance for the respective financial year is based on the value of the JU's residual error rate. This should, as follows from the common R&I Family target expressed in the legislative financial statement accompanying the Commission's proposal for the Horizon 2020 regulation, remain within a range of 2 to 5%, aiming to be as close as possible to 2%. However, the JU's control objective is to ensure for the H2020 Programme, that the residual error rate, which represents the level of errors that remain undetected and uncorrected, does not exceed 2% of the total expense recognised until the end of the Programme. Nevertheless, even before the end of the Programme, if the value of the residual error rate is not below 2% at the end of the respective reporting year, the ED might still make a reservation. For this, in addition to this quantitative threshold, the qualitative aspects of the underlying weaknesses will be considered as well before finally deciding on making a reservation, such as:

- The nature and scope of the weaknesses;
- The duration of the weaknesses;
- The existence of compensatory measures (mitigating controls which reduce the impact of the weaknesses);
- The existence of effective corrective actions to correct the weaknesses (action plans and financial corrections) which have had a measurable impact.

The starting point to determine the effectiveness of the controls in place is the “representative error rate” expressed as a percentage of errors in favour of the JU detected by ex-post audits measured with respect to the amounts accepted after ex-ante controls.

The representative error rate will be calculated as the weighted average (WAER) for a population, from which a representative sample has been drawn, according to the following formula:

$$\text{WAER\%} = \frac{\sum (\text{err})}{A} = \text{RepER\%}$$

Where:

$\sum (\text{err})$ = sum of all individual error rates of the sample (in value). Only those errors in favour of the JU will be taken into consideration.

A = total amount of the representative audited sample expressed in EUR.

Second step - calculation of the residual error rate:

To take into account the impact of the ex-post controls, this error level is to be adjusted by subtracting:

- errors detected and corrected as a result of the implementation of audit conclusions;
- errors corrected as a result of the extrapolation of audit results to non-audited contracts with the same beneficiary.

This results in a residual error rate, which is calculated by using the following formula:

$$\text{ResER\%} = \frac{(\text{RepER\%} * (P - A)) - (\text{RepERsys\%} * E)}{P}$$

Where:

ResER% = residual error rate, expressed as a percentage.

RepER% = representative error rate, or error rate detected in the representative sample, in the form of the WAER, expressed as a percentage and calculated as described above (WAER%).

RepERsys% = systematic portion of the RepER% (the RepER% is composed of complementary portions reflecting the proportion of ‘systematic’ and ‘non-systematic’ errors detected) expressed as a percentage.

P = total amount of the auditable population of cost claims, expressed in EUR.

A = total of all audited amounts, expressed in EUR.

E = total non-audited amounts of all audited beneficiaries. This will comprise the total amount, expressed in EUR, of all non-audited but validated and paid costs for all audited beneficiaries, excluding those beneficiaries for which an extrapolation is ongoing.

This calculation will be performed on a point-in-time basis, i.e. all the figures will be provided as of a certain date.

ANNEX J: LIST OF ACRONYMS

Abbreviation	
ABAC	Accrual Based Accounting
ADI	Austempered Ductile Iron
AO	Authorising Officer
ATO	Automated Train Operation
AWP	Annual Work Plan
BOA	Back Office Arrangements
CA	Commitment Appropriation
CAAR	Consolidated Annual Activity Report
CAS	Common Audit Service
CAPEX	Capital Expenditure
CBM	Condition-Based Maintenance
CBO	Common Business Objectives
CBTC	Communication Based Train Control
CCA	Cross Cutting Activities
CEN	European Committee for Standardisation
CENELEC	European Committee for Electrotechnical Standardisation
CFM	Call for Members
Covid-19	'CO' stands for corona, 'VI' for 'virus, and 'D' for disease. Formerly, this disease was referred to as '2019 novel coronavirus' or '2019-nCoV.' The COVID-19 virus is a new virus linked to the same family of viruses as Severe Acute Respiratory Syndrome (SARS) and some types of common cold.
CRS	Common Representative Sample
CREL	Core Release
CSA	Coordination and support action
CW	Cloud Wallet
DOI	Digital Object Identifier
DRIMS	Dynamic Railway Information Management System
EC	European Commission
ECA	European Court of Auditors
ED	Executive Director
EDPS	European Data Protection Supervisor
ED-SIPB	ED System and Innovation Programme Board
EDV	Electronic Distributor Valve
EMC	Electromagnetic Compatibility
EMI	Electromagnetic Interference
EN	European Norm
ERA	European Union Agency for Railways
ERRAC	European Rail Research Advisory Council
ERTMS	European Rail Traffic Management System
ETCS	European Train Controlling System
EU	European Union

EUAN	European Union Agencies Network
EUG	ERTMS Users Group
EU-Rail	The Europe's Rail Joint Undertaking
FACTs	Flexible AC Transmission Systems
FFFIS	Form Fit Functional Interface Specifications
FIS	Functional Interface Specifications
FREL	Final Release
GA	Grant Agreement
GDPR	General Data Protection Regulation
GIS	Geographic Information System
GNSS	Global Navigation Satellite System
GoA	Grade of Automation
H2020	Horizon 2020, EU framework programme for Research and Innovation
HST	High-Speed Train
HVAC	Heating, Ventilation Air Conditioning and Cooling
IA	Innovation Action
IAMS	Intelligent Asset Management System
IAS	Internal Audit Service
ICT	Information and Communications Technology
IEC	International Electrotechnical Commission
IKAA	in-kind contributions to additional activities
IP	Innovation Programme/Innovation Pillar
IPR	Intellectual Property Rights
ISO	International Standardisation Organisation
IT	Information Technology
ITD	Integrated Technology Demonstrator
JTI	Joint Technology Initiative
JU	Joint Undertaking
KPI	Key Performance Indicator
LCC	Life Cycle Cost
LIDAR	Light Detection and Ranging
LP	Lighthouse Project
LTE	Long-Term Evolution (standard for wireless communication)
MAAP	Multi-Annual Action Plan
MaaS	Mobility as a Service
MB(S)	Moving block (System)
MC	Mission Critical
MNO	Mobile Network Operator
NaaS	Network as an Asset
NaaS	Network as a Service
NLOS	non-line-of-sight
NTP	Network Time Protocol
OC	Open Call

ODM	Operational Data Management
OMTS	On-board Multimedia and Telematics Services
OPEX	Operating Expenditure
PA	Payment Appropriation
RCA	Railway Command Control and Signalling Architecture
R&I	Research and Innovation
PPP	Public Private Partnership
PRM	Persons with Reduced Mobility
PTC	Positive Train Control
PTI	Platform Train Interface
QoA	Quality of Service
RAL	Unpaid amount
RAMS	Reliability and Maintainability System
RBC	Radio Block Centre
RFID	Radio Frequency Identification
RIA	Research and innovation action
RoI	Return of Investment
S2R	Shift2Rail
SBA	The Single Basic Act - Council Regulation (EU) 2021/2085 of 19 November 2021 establishing the Joint Undertakings under Horizon Europe
SC	Scientific Committee
SDG	Sustainable Development Goals
SETA	Single European Transport Area
SEMP	System Engineering Management Plan
SiC	Silicon Carbide
SIR	Staff Implementing Rules
SLA	Service Level Agreement
SME	Small and Medium Enterprise
SNE	Seconded National Expert
SP	System Pillar
SPD	System Platform Demonstration
SPSG	System Pillar Steering Group
SRG	States Representatives Group
SWL	Single Wagon Load
TAF	Telematic Application for Freight
TAP	Telematic Application for Passengers
TCMS/NG-TCMS	Train Control and Monitoring System/Next Generation Train Control and Monitoring System
TCO	Total Cost of Ownership
TD	Technology Demonstrator
TL	Train Load
TMS	Traffic Management System
TRL	Technology Readiness Level
TSI	Technical Specifications for Interoperability

TSP	Travel Service Provider
UAV	Unmanned Aerial Vehicle
UG	User Group
UN	United Nations
WA	Work Area
WP	Work Package
WSP	Wheel Slide Protection

ANNEX K: INFORMATION PERTAINING TO THE FORMER SHIFT2RAIL JOINT UNDERTAKING

List of Members of the S2R JU until 29/11/2021

Founding Members



Associated Members



Virtual Vehicle Austria Consortium (VVAC+)



European Rail Operating community Consortium (EUROC)



SwiTracken Consortium



Smart DeMain(SDM) Consortium



AERFITEC



Competitive Freight Wagon Consortium(CFW)



Smart Rail Control (SmartRaCon) consortium



Factsheet of the S2R JU as at 29/11/2021

Name	Shift2Rail Joint Undertaking (also referred to as "S2R JU" or "S2R")
Objectives	<p>The Shift2Rail Joint Undertaking is a public-private partnership in the rail sector, providing a platform for cooperation that drives innovation in the years to come. The S2R JU pursues research and innovation (R&I) activities in support of the achievement of the Single European Railway Area and should improve the attractiveness and competitiveness of the European rail system.</p> <p>The S2R JU contributes to:</p> <ul style="list-style-type: none"> • a 50 % reduction of the life-cycle cost of the railway transport system (i.e. costs of building, operating, maintaining and renewing infrastructure and rolling stock), • a 100 % increase in the capacity of the railway transport system, • a 50 % increase in the reliability and punctuality of rail services (measured as a 50 % decrease in unreliability and late arrivals). <p>The S2R JU shall propose innovative solutions to be explored, tested and demonstrated in operational environment and/or "zero on site" to achieve market uptake. Beyond that, with the deployment of its innovative solutions the S2R JU will foster connections between people, regions, cities, and businesses, supporting the socioeconomic objectives of the Union.</p>
Founding Legal Act	Council Regulation (EU) No 642/2014 of 16 June 2014 establishing the Shift2Rail Joint Undertaking ⁸⁴ (S2R Regulation)
Executive Director (ED)	Mr Carlo M. Borghini, as from 16 May 2016
Governing Board (S2R GB) As at end of Jan 2021	<p>European Commission (EC) members:</p> <ul style="list-style-type: none"> • <i>Henrik Hololei</i>, DG MOVE <p>EC alternates:</p> <ul style="list-style-type: none"> • MOVE DDG 2 <i>Kristian Schmidt</i> • RTD D <i>Rosalinde Van Der Vlies</i> <p>Industry members:</p> <ul style="list-style-type: none"> • ALSTOM <i>Nicolas Castres Saint Martin</i> • AŽD Praha <i>Vladimir Kampik</i> • BOMBARDIER TRANSPORTATION <i>Nicolas Castres Saint Martin</i> • CAF <i>Imanol Iturrioz</i> • DEUTSCHE BAHN <i>Hans Peter Lang</i> • EUROC <i>Thomas Petraschek</i> • HACON <i>Lars Deiterding</i> • HITACHI RAIL STS <i>Antonella Trombetta</i> • INDRA <i>Javier Rivilla Lizano</i> • KNORR-BREMSE <i>Hans-Christian Hilse</i> • NETWORK RAIL <i>Robert Ampomah</i> • SIEMENS <i>Roland Edel</i> • SMARTDEMAIN <i>Henk Samson</i> • SMARTRACON <i>Michael Meyer zu Hörste</i> • SNCF <i>Carole Desnost</i> • THALES <i>Yves Perreal (Industrial Spokesperson)</i>

⁸⁴ OJ L 177, 17.6.2014, p. 9

	<ul style="list-style-type: none"> • TRAFIKVERKET <i>Bo Olsson</i> • VVAC+ <i>Filip Kitanoski</i> <p>Industry alternates:</p> <ul style="list-style-type: none"> • ALSTOM <i>Sophie Perrocheau</i> • AŽD Praha <i>Michal Pavel</i> • BOMBARDIER TRANSPORTATION <i>Richard French</i> • CAF <i>Jorge De Castro</i> • DEUTSCHE BAHN <i>Ralf Marxen</i> • EUROCC <i>not appointed</i> • HACON <i>Rolf Gooßmann</i> • HITACHI RAIL STS <i>Claudio Monti</i> • INDRA <i>not appointed</i> • KNORR-BREMSE <i>Jasmina Brackovic</i> • NETWORK RAIL <i>Felicity Osborn</i> • SIEMENS <i>Jürgen Schlaht</i> • SMARTDEMAIN <i>Javier Bonilla Díaz</i> • SMARTRACON <i>Jaizki Mendizabal</i> • SNCF <i>Christophe Cheron</i> • THALES <i>Alberto Parrondo</i> • TRAFIKVERKET <i>Christer Lofving</i> • VVAC+ <i>Erik Stocker</i> <p>Other participants:</p> <ul style="list-style-type: none"> • <i>Carlo M Borghini</i> Executive Director of EU-Rail <p>Observers:</p> <ul style="list-style-type: none"> • <i>Josef Doppelbauer</i> (ERA) • <i>Ana Gigantino</i> (ERA) • <i>Ny Tiana Tournier</i> (ERA) • <i>Angela Di Febbraro</i> (SC Chair) • <i>Sarah Bittner-Krautsack</i> (SRG Chair) • <i>Miroslav Haltuf</i> (SRG Vice Chair)
<p>Other bodies</p>	<p>Scientific Committee (SC) States Representatives Group (SRG) Innovation Programmes' Steering Committees (IP SteCos)</p>
<p>Strategic Research Agenda</p>	<p>In accordance with the S2R Regulation, the strategic research and innovation agenda of the S2R JU is described in the Multi-Annual Action Plan (MAAP) adopted in its latest version in November 2019, by means of the GB Decision N° 9/2019.</p> <p>The original MAAP of 2015 is maintained as a reference document.</p>

ANNEX L: LIST OF FOUNDING MEMBERS OF THE EUROPE'S RAIL JOINT UNDERTAKING

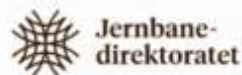



RAIL-RESEARCH.EUROPA.EU

